

HILTI

SID 14-A

SID 18-A

SIW 14-A

SIW 18-A

Original operating instructions
Mode d'emploi original
Manual de instrucciones original

en
fr
es

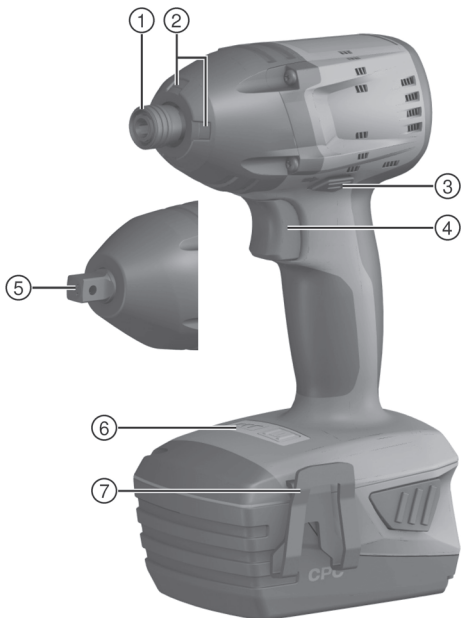

1

B14/1.6

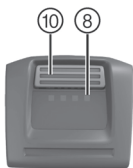

B14/3.3

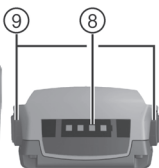
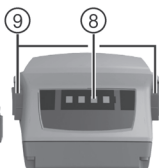
B18/1.6
B18/2.6 (02)B18/2.6 (01)
B18/3.3
B18/5.2 (01)

ETL listed to US and Canadian safety standards
 Homologué ETL (conforme aux normes de sécurité américaines et canadiennes)
 Producto homologado según normas de seguridad americanas y canadienses
 Produto homologado de acordo com as normas de segurança americanas e canadenses

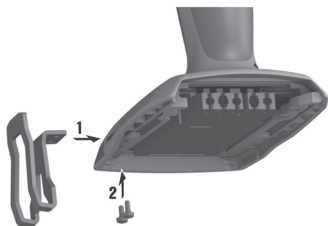
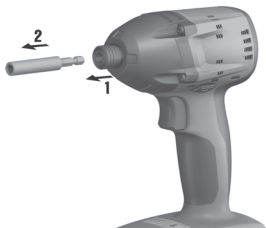

2**3****4****5**

6

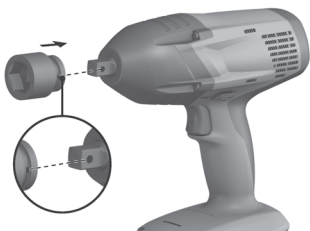

7



8



I



II



III

9

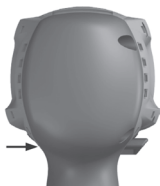

10

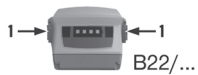

1 Information about the documentation

1.1 Conventions

1.1.1 Warning signs

The following warning signs are used:

	General warning
---	-----------------

1.1.2 Symbols

The following symbols are used:

	Read the operating instructions before use.
---	---

	Instructions for use and other useful information
---	---

n_0	Rated speed under no load
-------	---------------------------

/min	Revolutions per minute
------	------------------------

	Direct current (DC)
---	---------------------

1.1.3 Typographic emphasis

The following typographic features are used to emphasize important passages in the technical documentation about your impact screwdriver/wrench:

	These numbers refer to the corresponding illustrations.
---	---

1.2 Operating instructions

- ▶ **It is essential that the operating instructions are read before initial operation.**
- ▶ **Always keep these operating instructions together with the tool.**
- ▶ **Ensure that the operating instructions are with the tool when it is given to other persons.**

Changes and errors excepted.

1.3 Product information

The type designation can be found on the type identification plate at the base of the tool and the serial number on the side of the casing.

- ▶ Make a note of this data in the following table and always refer to it when making an enquiry to your Hilti representative or Hilti Service Center.

Product information

Type:	
Generation:	01
Serial no.:	

2 Safety

2.1 Warnings

The purpose of warnings

Warnings alert persons to hazards that occur when handling or using the product.

Description of the key words used



DANGER

Draws attention to imminent danger that will lead to serious personal injury or fatality.



WARNING

Draws attention to a potentially dangerous situation that could lead to serious personal injury or fatality.



CAUTION

Draws attention to a potentially dangerous situation that could lead to slight personal injury or damage to the equipment or other property.

2.2 Safety instructions

The safety rules given in the following section contain all general safety rules for electric tools which, in accordance with the applicable standards, require to be listed in the operating instructions. Accordingly, some of the rules listed may not be relevant to this electric tool.

2.2.1 General power tool safety warnings

WARNING

Read all safety warnings and all instructions. Failure to follow the warnings and instructions may result in electric shock, fire and/or serious injury.

Save all warnings and instructions for future reference.

The term “power tool” in the warnings refers to your mains-operated (corded) power tool or battery-operated (cordless) power tool.

Work area safety

- ▶ **Keep work area clean and well lit.** Cluttered or dark areas invite accidents.
- ▶ **Do not operate power tools in explosive atmospheres, such as in the presence of flammable liquids, gases or dust.** Power tools create sparks which may ignite the dust or fumes.
- ▶ **Keep children and bystanders away while operating a power tool.** Distractions can cause you to lose control.

Electrical safety

- ▶ **Power tool plugs must match the outlet. Never modify the plug in any way. Do not use any adapter plugs with earthed (grounded) power tools.** Unmodified plugs and matching outlets will reduce risk of electric shock.

- ▶ **Avoid body contact with earthed or grounded surfaces, such as pipes, radiators, ranges and refrigerators.** There is an increased risk of electric shock if your body is earthed or grounded.
- ▶ **Do not expose power tools to rain or wet conditions.** Water entering a power tool will increase the risk of electric shock.
- ▶ **Do not abuse the cord. Never use the cord for carrying, pulling or unplugging the power tool. Keep cord away from heat, oil, sharp edges or moving parts.** Damaged or entangled cords increase the risk of electric shock.
- ▶ **When operating a power tool outdoors, use an extension cord suitable for outdoor use.** Use of a cord suitable for outdoor use reduces the risk of electric shock.
- ▶ **If operating a power tool in a damp location is unavoidable, use a residual current device (RCD) protected supply.** Use of an RCD reduces the risk of electric shock.

Personal safety

- ▶ **Stay alert, watch what you are doing and use common sense when operating a power tool. Do not use a power tool while you are tired or under the influence of drugs, alcohol or medication.** A moment of inattention while operating power tools may result in serious personal injury.
- ▶ **Use personal protective equipment. Always wear eye protection.** Protective equipment such as dust mask, non-skid safety shoes, hard hat, or hearing protection used for appropriate conditions will reduce personal injuries.
- ▶ **Prevent unintentional starting. Ensure the switch is in the off-position before connecting to power source and/or battery pack, picking up or carrying the tool.** Carrying power tools with your finger on the switch or energising power tools that have the switch on invites accidents.
- ▶ **Remove any adjusting key or wrench before turning the power tool on.** A wrench or a key left attached to a rotating part of the power tool may result in personal injury.
- ▶ **Do not overreach. Keep proper footing and balance at all times.** This enables better control of the power tool in unexpected situations.
- ▶ **Dress properly. Do not wear loose clothing or jewellery. Keep your hair, clothing and gloves away from moving parts.** Loose clothes, jewellery or long hair can be caught in moving parts.
- ▶ **If devices are provided for the connection of dust extraction and collection facilities, ensure these are connected and properly used.** Use of dust collection can reduce dust-related hazards.

Power tool use and care

- ▶ **Do not force the power tool.** Use the correct power tool for your application. The correct power tool will do the job better and safer at the rate for which it was designed.

- ▶ **Do not use the power tool if the switch does not turn it on and off.** Any power tool that cannot be controlled with the switch is dangerous and must be repaired.
- ▶ **Disconnect the plug from the power source and/or the battery pack from the power tool before making any adjustments, changing accessories, or storing power tools.** Such preventive safety measures reduce the risk of starting the power tool accidentally.
- ▶ **Store idle power tools out of the reach of children and do not allow persons unfamiliar with the power tool or these instructions to operate the power tool.** Power tools are dangerous in the hands of untrained users.
- ▶ **Maintain power tools. Check for misalignment or binding of moving parts, breakage of parts and any other condition that may affect the power tool's operation. If damaged, have the power tool repaired before use.** Many accidents are caused by poorly maintained power tools.
- ▶ **Keep cutting tools sharp and clean.** Properly maintained cutting tools with sharp cutting edges are less likely to bind and are easier to control.
- ▶ **Use the power tool, accessories and tool bits etc. in accordance with these instructions, taking into account the working conditions and the work to be performed.** Use of the power tool for operations different from those intended could result in a hazardous situation.

Battery tool use and care

- ▶ **Recharge only with the charger specified by the manufacturer.** A charger that is suitable for one type of battery pack may create a risk of fire when used with another battery pack.
- ▶ **Use power tools only with specifically designated battery packs.** Use of any other battery packs may create a risk of injury and fire.
- ▶ **When battery pack is not in use, keep it away from other metal objects, like paper clips, coins, keys, nails, screws or other small metal objects, that can make a connection from one terminal to another.** Shorting the battery terminals together may cause burns or a fire.
- ▶ **Under abusive conditions, liquid may be ejected from the battery; avoid contact. If contact accidentally occurs, flush with water. If liquid contacts eyes, additionally seek medical help.** Liquid ejected from the battery may cause irritation or burns.

Service

- ▶ **Have your power tool serviced by a qualified repair person using only identical replacement parts.** This will ensure that the safety of the power tool is maintained.

2.2.2 Warnings for drivers

- ▶ **Hold power tool by insulated gripping surfaces, when performing an operation where the fastener may contact hidden wiring or its own cord.** Fasteners contacting a "live" wire may make exposed metal parts of the power tool "live" and could give the operator an electric shock.

2.2.3 Additional safety instructions

Personal safety

- ▶ **Tampering with or modification of the tool is not permitted.**
- ▶ **Wear ear protectors.** Exposure to noise can cause hearing loss.
- ▶ **Respiratory protection must be worn if the power tool is used without a dust removal system for work that creates dust.**
- ▶ **Improve the blood circulation in your fingers by relaxing your hands and exercising your fingers during breaks between working.**
- ▶ **Avoid touching rotating parts. Switch the power tool on only after bringing it into position at the workpiece.** Touching rotating parts, especially rotating accessory tools, may lead to injury.
- ▶ **Activate the safety lock (forward/reverse selector switch in the middle position) when changing accessory tools or batteries and before storage or transportation of the power tool.**
- ▶ **The power tool is not intended for use by debilitated persons who have received no special training. Keep the power tool out of reach of children.**
- ▶ **Dust from materials, such as paint containing lead, some wood species, concrete/masonry/stone containing silica, and minerals as well as metal, may be harmful. Contact with or inhalation of the dust may cause allergic reactions and/or respiratory or other diseases to the operator or bystanders. Certain kinds of dust such as oak and beech wood dust are classified as carcinogenic, especially in conjunction with additives for wood conditioning (chromate, wood preservative). Material containing asbestos may be handled only by specialists. Use a dust removal system whenever possible. To achieve a high level of dust collection, use a suitable vacuum cleaner. If necessary, wear a respirator appropriate for the type of dust generated. Ensure that the workplace is well ventilated. Follow national requirements for the materials you want to work with.**
- ▶ **The user and any other persons in the vicinity must wear suitable eye protection, a hard hat, ear protection, protective gloves and breathing protection while the power tool is in use.**

Use and care of electric tools

- ▶ **Secure the workpiece. Use clamps or a vice to hold the workpiece in position.** The workpiece is thus held more securely than by hand and both hands remain free to operate the power tool.

- ▶ **Check that accessory tools are compatible with the power tool's chuck/drive system and that they are fitted and secured correctly.**
- ▶ **Make sure that the screws or bolts and the workpiece are suitable for the level of torque generated by the power tool.** Excessive torque may overstress, stretch or strip the screws/bolts or damage the workpiece, thus leading to hazardous situations.

Use and care of battery-powered devices

- ▶ **Check that the tool is switched off before inserting the battery.** Inserting a battery into an electric tool that is switched on can lead to accidents.
- ▶ **Do not expose batteries to high temperatures and keep them away from fire.** There is a risk of explosion.
- ▶ **Do not disassemble, squash or incinerate batteries and do not subject them to temperatures over 80°C (176°F).** This presents a risk of fire, explosion or injury through contact with caustic substances.
- ▶ **Avoid ingress of moisture.** Ingress of moisture may cause a short circuit, resulting in burning injuries or fire.
- ▶ **Remove the battery before storing or transporting the power tool.**
- ▶ **Avoid short circuiting the battery terminals. Check that the battery terminals and the terminals in the power tool are free from foreign objects before inserting the battery in the tool.** Short circuiting the battery terminals presents a risk of fire, explosion and chemical burns.
- ▶ **Do not continue to use or attempt to charge damaged batteries (e.g. batteries with cracks, broken parts, bent or pushed-in/pulled-out contacts).**
- ▶ If the battery is too hot to touch it may be defective. **In this case, place the power tool in a non-flammable location, well away from flammable materials, where it can be kept under observation and allowed to cool down. Contact HiltiService after the battery has cooled down.**

Electrical safety

- ▶ **Before beginning work, check the working area (e.g. using a metal detector) to ensure that no concealed electric cables or gas and water pipes are present.** External metal parts of the power tool may become live, for example, when an electric cable is damaged accidentally. This presents a serious risk of electric shock.

3 Description

3.1 Overview of the product

- | | |
|--|--|
| ① Hex. socket (SID) | ④ Control switch (with electronic speed control) |
| ② Illumination | ⑤ Square drive (SIW) |
| ③ Forward/reverse selector switch with safety lock | ⑥ Torque selector button |
| | ⑦ Belt hook (optional) |

- ⑧ Battery charge status display
- ⑨ Release buttons (B18/... battery)

- ⑩ Release button (B14/... battery)

3.2 Intended use

The product described is a hand-held, cordless impact screwdriver/wrench for driving and removing screws or tightening and releasing threaded nuts and bolts in wood, metal, masonry and concrete.

Hilti products are designed for professional use and may be operated, serviced and maintained only by trained, authorized personnel. This personnel must be informed of any particular hazards that may be encountered. The impact screwdriver/wrench and its ancillary equipment may present hazards when used incorrectly by untrained personnel or when used not as directed.

- ▶ Do not use the battery as a power source for other unspecified appliances.
- ▶ Observe the national health and safety requirements.
- ▶ To reduce the risk of injury, use only genuine **Hilti** tools and accessories.
- ▶ To power the impact screwdriver/wrench, use a rechargeable battery of a type approved by **Hilti** and a charger from the C4/36 series.



Note

Make sure that the outer surfaces of the battery are clean and dry before inserting the battery in an approved battery charger.

Read the operating instructions for the charger for further information about the charging procedure.

If the power tool is used for applications that require a specific torque, or where a certain maximum torque must not be exceeded, there is a risk of over-tightening and damage to the screw or workpiece.

- ▶ Do not use the power tool for applications that require a precise or specified torque. Instead, use a tool that allows the torque to be set as required.

3.3 Charge status display

The charge status of the Li-ion battery is displayed after pressing one of the release buttons lightly (press only until slight resistance is felt).

Status	Meaning
4 LEDs light.	• Charge status: 75 % to 100 %
3 LEDs light.	• Charge status: 50 % to 75 %
2 LEDs light.	• Charge status: 25 % to 50 %
1 LED lights.	• Charge status: 10 % to 25 %
1 LED blinks.	• Charge status: < 10 %

**Note**

Battery charge status cannot be displayed while the control switch is pressed and for up to 5 seconds after releasing the control switch.

3.4 Items supplied

Impact screwdriver/wrench, operating instructions.

**Note**

To help ensure safe and reliable operation, use only genuine Hilti spare parts and consumables. Spare parts, consumables and accessories approved by us for use with the product can be found at your local **Hilti** Center or online at: www.hilti.com

4 Technical data**4.1 Impact screwdriver/wrench**

		SID 14-A	SIW 14-A
Rated voltage		14.4 V	14.4 V
Weight (including battery and chuck)		2.9 lb (1.3 kg)	2.9 lb (1.3 kg)
Rated speed under no load	Setting I	0 Hz ... 16.7 Hz (0 rpm ... 1,000 rpm)	0 Hz ... 16.7 Hz (0 rpm ... 1,000 rpm)
	Setting II	0 Hz ... 25.0 Hz (0 rpm ... 1,500 rpm)	0 Hz ... 25.0 Hz (0 rpm ... 1,500 rpm)
	Setting III	0 Hz ... 41.7 Hz (0 rpm ... 2,500 rpm)	0 Hz ... 38.3 Hz (0 rpm ... 2,300 rpm)
Impact speed		≤ 3,100 bpm	≤ 3,400 bpm
Torque adjustment		3 settings	3 settings
Large standard bolts		M8 to M16	M8 to M16
Large high-strength bolts		M6 to M12	M6 to M12
Socket/bit drive		1/4" hex. socket with locking ring	1/2" square drive with ball-notch retention or 3/8" square drive with locking ring

		SID 18-A	SIW 18-A
Rated voltage		21.6 V	21.6 V
Weight (including battery and chuck)		3.3 lb (1.5 kg)	3.3 lb (1.5 kg)
Rated speed under no load	Setting I	0 Hz ... 16.7 Hz (0 rpm ... 1,000 rpm)	0 Hz ... 16.7 Hz (0 rpm ... 1,000 rpm)
	Setting II	0 Hz ... 25.0 Hz (0 rpm ... 1,500 rpm)	0 Hz ... 25.0 Hz (0 rpm ... 1,500 rpm)
	Setting III	0 Hz ... 41.7 Hz (0 rpm ... 2,500 rpm)	0 Hz ... 38.3 Hz (0 rpm ... 2,300 rpm)
Impact speed		≤ 3,450 bpm	≤ 3,500 bpm
Torque adjustment		3 settings	3 settings
Large standard bolts		M8 to M16	M8 to M16
Large high-strength bolts		M6 to M12	M6 to M12
Socket/bit drive		1/4" hex. socket with locking ring	1/2" square drive with ball-notch retention or 3/8" square drive with locking ring

4.2 Setting the torque

The torque is selected by way of the torque selector button.

Model SID ...

SID 14-A

SID 18-A

	Model	
	SID 14-A	SID 18-A
Setting I	37 ft·lb _f (50 N·m)	44 ft·lb _f (60 N·m)
Setting II	74 ft·lb _f (100 N·m)	81 ft·lb _f (110 N·m)
Setting III	111 ft·lb _f (150 N·m)	122 ft·lb _f (165 N·m)

Model SIW ...

SIW 14-A

SIW 18-A

	SIW 14-A		SIW 18-A	
	1/2" square drive with ball-notch retention	3/8" square drive with locking ring	1/2" square drive with ball-notch retention	3/8" square drive with locking ring
Setting I	59 ft·lb _f (80 N·m)	48 ft·lb _f (65 N·m)	66 ft·lb _f (90 N·m)	55 ft·lb _f (75 N·m)
Setting II	89 ft·lb _f (120 N·m)	85 ft·lb _f (115 N·m)	100 ft·lb _f (135 N·m)	89 ft·lb _f (120 N·m)
Setting III	136 ft·lb _f (185 N·m)	118 ft·lb _f (160 N·m)	148 ft·lb _f (200 N·m)	129 ft·lb _f (175 N·m)

4.3 Battery

	B 14/1.6 Li-Ion	B 14/3.3 Li-Ion	B 18/1.6 Li-Ion	B 18/2.6 Li-Ion (01)
Rated voltage	14.4 V	14.4 V	21.6 V	21.6 V
Capacity	1.6 A·h	3.3 A·h	1.6 A·h	2.6 A·h
Energy capacity	23.04 W·h	47.52 W·h	34.56 W·h	56.16 W·h
Weight	0.79 lb (0.36 kg)	1.30 lb (0.59 kg)	1.06 lb (0.48 kg)	1.72 lb (0.78 kg)

	B 18/2.6 Li-Ion (02)	B 18/3.3 Li-Ion	B 18/5.2 Li-Ion (01)
Rated voltage	21.6 V	21.6 V	21.6 V
Capacity	2.6 A·h	3.3 A·h	5.2 A·h
Energy capacity	56.16 W·h	71.28 W·h	112.32 W·h
Weight	1.06 lb (0.48 kg)	1.72 lb (0.78 kg)	1.72 lb (0.78 kg)

5 Operation

5.1 Inserting the battery



WARNING

Risk of injury! Inadvertent starting of the impact screwdriver.

- Before fitting the battery, check that the cordless impact screwdriver is switched off and that the forward/reverse switch is in the middle position (i.e. safety lock engaged).



WARNING

Electrical hazards! Risk of short circuiting.

- ▶ Before inserting the battery, check to ensure that the battery terminals and the contacts in the impact screwdriver are free from foreign objects.



WARNING

Risk of injury! Hazard presented by a falling battery.

- ▶ A falling battery may present a risk of injury to yourself and others. Check that the battery is securely seated in the power tool.

- ▶ Fit the battery and make sure that it is heard to engage.

5.2 Fitting the belt hook (optional) 3



WARNING

Risk of injury! Hazard presented by a falling power tool.

- ▶ A falling power tool may present a risk of injury to yourself and others. Check that the belt hook is fitted securely before beginning work.



Note

The belt hook allows the power tool to be attached to a belt worn by the operator. The belt hook can be fitted to allow attachment on the left or right side of the body.

- ▶ Fit the belt hook.

5.3 Fitting an accessory tool 4

SID 14-A

SID 18-A

1. Check that the connection end of the accessory tool is clean.

Result

The connection end is dirty.

- ▶ Clean the connection end.

2. Set the forward/reverse switch to the middle position or remove the battery from the power tool.
3. Push the accessory tool into the chuck as far as it will go (until it engages).

5.4 Removing the accessory tool 5

SID 14-A

SID 18-A



CAUTION

Risk of injury. The accessory tool may be hot or have sharp edges.

- ▶ Wear protective gloves when using the power tool and when changing accessory tools.

1. Set the forward/reverse switch to the middle position or remove the battery from the power tool.
2. Pull the chuck ring forward and hold it in this position.
3. Pull the accessory tool out of the chuck.
4. Release the chuck ring.

5.5 Fitting an accessory tool 6

SIW 14-A

SIW 18-A

1. Check that the connection end of the accessory tool is clean.

Result

The connection end is dirty.

- ▶ Clean the connection end.
2. Set the forward/reverse switch to the middle position or remove the battery from the power tool.
 3. Bring the notch in the accessory tool into alignment with the ball on the square drive.
 4. Push the accessory tool onto the square drive until it engages.

5.6 Removing the accessory tool 7

SIW 14-A

SIW 18-A



CAUTION

Risk of injury. The accessory tool may be hot or have sharp edges.

- ▶ Wear protective gloves when using the power tool and when changing accessory tools.

1. Set the forward/reverse switch to the middle position or remove the battery from the power tool.
2. Pull the accessory tool off the square drive.

5.7 Setting the torque 8



Technical data

✦ Model SID ... (SID 14-A OR SID 18-A) → Seite 9

✦ Model SIW ... (SIW 14-A OR SIW 18-A) → Seite 9

- ▶ Press the torque selector button as many times as necessary until the desired torque setting is indicated to the left of the button.

SID 14-A

SID 18-A

Model SID ... (SID 14-A OR SID 18-A) → Seite 9

SIW 14-A

SIW 18-A

Model SIW ... (SIW 14-A OR SIW 18-A) → Seite 9

5.8 Setting forward or reverse rotation **9**



Note

An interlock prevents switching while the motor is running.

The control switch is locked when the forward/reverse switch is in the middle position (safety lock).

- ▶ Set the forward/reverse switch to the desired direction of rotation.

5.9 Screwdriving



WARNING

Risk of injury and damage. Screws/bolts or the workpiece may be damaged by excessively high torque; this may also lead to serious injury.

- ▶ Ensure fastener and attachment will withstand the level of torque generated by the tool.

1. Set the forward/reverse switch to the middle position or remove the battery from the power tool.
2. Use the torque selector button to set the desired torque. → Seite 12

5.10 Switching on

- ▶ Press the control switch.
 - ◀ Speed of rotation is regulated by the distance the control switch is pressed in.

5.11 Switching off

- ▶ Release the control switch.

5.12 Removing the battery **10**

- ▶ Remove the battery.

6 Care, maintenance, transport and storage

6.1 Care and maintenance of the tool



WARNING

Electrical hazards! Improper repairs to electrical parts may lead to serious injuries.

▶ Electrical parts may be repaired only by trained electrical specialists.

- ▶ Keep the tool, especially its grip surfaces, clean and free from oil and grease. Do not use cleaning agents containing silicone.
- ▶ Never operate the power tool when the ventilation slots are blocked. Clean the air vents carefully using a dry brush. Do not permit foreign objects to enter the interior of the tool.
- ▶ Clean the outer surfaces of the tool with a slightly damp cloth at regular intervals.

6.2 Care of the Li-ion battery

- ▶ Keep the battery clean and free from oil and grease.
- ▶ Clean the outer surfaces of the tool with a slightly damp cloth at regular intervals. Do not use cleaning agents containing silicone.
- ▶ To achieve maximum battery life, stop drawing power from the battery as soon as a significant drop in the performance of the power tool is noticed.
- ▶ Charge the batteries using the **Hilti** chargers approved for use with Li-ion batteries.

6.3 Transport and storage



WARNING

Risk of fire! Risk of short circuiting.

▶ To avoid short circuits and associated heat generation, Li-ion batteries should never be stored or transported in loose, bulk form and without protective measures.

- ▶ Remove the battery before transporting or storing the impact screwdriver/wrench.

- Observe the nationally and internationally applicable transport regulations when shipping batteries by road, rail, sea or air.



Note

Ideally, the battery should be stored in a fully-charged state in a dry place that is as cool as possible. Storing the battery in places subject to high ambient temperatures (e.g. at a window) has an adverse effect on battery life and increases the rate of self-discharge.

If the battery no longer reaches full charge, it may have lost capacity due to aging or overstressing. It is still possible to work with this battery. You should, however, soon replace the battery with a new one.

7 Troubleshooting

If the trouble you are experiencing is not listed in this table or you are unable to remedy the problem by yourself, please contact **Hilti Service**.

Trouble or fault	Possible cause	Action to be taken
The power tool doesn't run.	The battery is not fully inserted.	► Push the battery in until it engages with an audible double click.
	Low battery.	► Change the battery and charge the empty battery.
The control switch can't be pressed, i.e. the switch is locked.	The forward/reverse selector switch is in the middle position.	► Push the forward/reverse switch to the left or right.
Running speed suddenly drops considerably.	Low battery.	► Change the battery and charge the empty battery.
The battery runs down more quickly than usual.	Very low ambient temperature.	► Allow the battery to warm up slowly to room temperature.
The battery doesn't engage with an audible double click.	The retaining lugs on the battery are dirty.	► Clean the retaining lugs and push the battery in until it engages. Contact Hilti Service if the problem persists.

Trouble or fault	Possible cause	Action to be taken
The power tool or the battery becomes very warm.	Electrical fault.	▶ Switch the power tool off immediately, remove the battery, keep it under observation, allow it to cool down and contact Hilti Service .
	The tool is overloaded (application limits exceeded).	▶ Select a suitable power tool for the application.

8 Disposal



CAUTION

Risk of injury! Hazards presented by improper disposal.

- ▶ Improper disposal of the equipment may have the following consequences: The burning of plastic components generates toxic fumes which may present a health hazard. Batteries may explode if damaged or exposed to very high temperatures, causing poisoning, burns, acid burns or environmental pollution. Careless disposal may permit unauthorized and improper use of the equipment. This may result in serious personal injury, injury to third parties and pollution of the environment.
- ▶ Dispose of defective batteries right away. Keep them out of reach of children. Do not disassemble or incinerate the batteries.
- ▶ Batteries that have reached the end of their life must be disposed of in accordance with national regulations or returned to **Hilti**.

 Most of the materials from which **Hilti** tools and appliances are manufactured can be recycled. The materials must be correctly separated before they can be recycled. In many countries, your old tools, machines or appliances can be returned to **Hilti** for recycling. Ask **Hilti Service** or your **Hilti** representative for further information.

9 Manufacturer's warranty

- ▶ Please contact your local **Hilti** representative if you have questions about the warranty conditions.

HILTI

Hilti Corporation

LI-9494 Schaan

Tel.: +423 / 234 21 11

Fax: +423 / 234 29 65

www.hilti.com

