



**DIVISIÓN: 03 00 00—CONCRETO**  
**Sección: 03 16 00—Anclajes de concreto**

**DIVISIÓN: 05 00 00—METALES**  
**Sección: 05 05 19—Anclajes de concreto post-  
 instalados**

**TITULAR DEL REPORTE:**

HILTI, INC.

**TEMA DE EVALUACIÓN:**

**ANCLAJES ADHESIVOS HILTI HIT-HY 200 V3 Y  
 CONEXIONES DE BARRAS DE REFUERZO POST  
 INSTALADAS EN CONCRETO**

### 1.0 ALCANCE DE LA EVALUACIÓN

**Cumplimiento con los siguientes códigos:**

- *Código Internacional de la Edificación™ (IBC®) 2021, 2018, 2015 y 2012*
- *Código Internacional Residencial™ (IRC®) 2021, 2018, 2015 y 2012*

Para evaluación del cumplimiento de los códigos adoptados por el *Departamento de Construcción y Seguridad de Los Angeles [Los Angeles Department of Building and Safety (LADBS)]*, ver el [ESR-4868 Suplemento LABC y LARC](#).

**Propiedad evaluada:**

Estructural

### 2.0 USOS

Los anclajes adhesivos y barras de refuerzo instaladas con el Sistema de Anclajes Adhesivos Hilti HIT-HY 200 V3 y el Sistema de Barras de Refuerzo Post-Instaladas se usan para resistir las cargas estáticas, por viento y sísmicas (Categorías de Diseño Sísmico A hasta F) de tensión y de cortante en concreto de densidad normal y de densidad liviana fisurado y no fisurado con una resistencia especificada a la compresión,  $f'_c$ , de 2,500 psi hasta 8,500 psi (17.2 MPa hasta 58.6 MPa).

El sistema de anclaje cumple con los anclajes descritos en la Sección 1901.3 del IBC 2021, 2018 y 2015 y en la Sección 1909 del IBC 2012 y es una alternativa para los anclajes preinstalados en sitio descritos en la Sección 1908 del IBC 2012. Los sistemas de anclajes también pueden utilizarse cuando se presenta el diseño de ingeniería de acuerdo con la Sección R301.1.3 del IRC.

El sistema de barras de refuerzo post-instaladas es una alternativa a las barras de refuerzo pre-instaladas en sitio gobernadas por ACI 318 y el Capítulo 19 del IBC

### 3.0 DESCRIPCIÓN

#### 3.1 General:

El Sistema de Anclajes Adhesivos Hilti HIT-HY 200 V3 y el Sistema de Barras de Refuerzo Post-instaladas están formados por los siguientes componentes:

- Adhesivo Hilti HIT-HY 200 V3 empacado en paquetes de aluminio (ya sea Hilti HIT-HY 200-A V3 o Hilti HIT-HY 200-R V3)
- Equipo para mezcla y aplicación del adhesivo
- Equipo para limpieza del agujero y para inyección del adhesivo

El Sistema de Anclajes Adhesivos Hilti HIT-HY 200 V3 puede usarse con varillas de roscado continuo, varillas de anclaje Hilti HIT-Z(-R), insertos Hilti HIS(-R) N de roscado interior o barras de refuerzo de acero corrugadas como se representa en la Figura 1. El Sistema de Barras de Refuerzo Post-instaladas Hilti HIT-HY 200 V3 solo puede usarse con barras de refuerzo de acero corrugadas como se representa en la Figura 2. Los componentes principales de los Sistemas de Anclajes Adhesivos y Barras de Refuerzo Post-instaladas, incluyendo el Adhesivo Hilti HIT-HY 200 V3, la boquilla de mezcla estática HIT-RE-M y elementos de anclaje de acero, se muestran en la Figura 5 de este reporte.

Las instrucciones de instalación impresas del fabricante (MP11) se incluyen en cada paquete de adhesivos como se reproduce en la Figura 6.

#### 3.2 Materiales:

**3.2.1 Adhesivo Hilti HIT-HY 200 V3:** El adhesivo Hilti HIT-HY 200 V3 es un adhesivo híbrido inyectable de dos componentes. Los dos componentes se separan por medio de un paquete de aluminio de doble cilindro unido a un colector. Los dos componentes se combinan y reaccionan cuando se aplican con la boquilla de mezcla estática unida al colector. El Hilti HIT-HY 200 V3 está disponible en paquetes de aluminio de 11.1-onzas (330 mL) y 16.9-onzas (500 mL). El colector unido a cada paquete de aluminio está marcado con la fecha de caducidad del adhesivo. La vida en almacén, como se indica por la fecha de caducidad, aplica al paquete de aluminio sin abrir almacenado en un lugar seco, oscuro y de acuerdo con la Figura 6.

El Adhesivo Hilti HIT HY 200 V3 está disponible en dos opciones, el Hilti HIT-HY 200-A V3 y el Hilti HIT-HY 200-R V3. Ambas opciones están sujetas a los mismos datos técnicos que se establecen en este reporte. El Hilti HIT-HY 200-A V3 tendrá tiempos de trabajo y tiempos de curado más cortos que el Hilti HIT-HY 200-R V3. El

empaques para cada opción emplea un color diferente, que ayuda al usuario a distinguir entre los dos adhesivos.

### 3.2.2 Equipo para la Limpieza del Agujero:

**3.2.2.1 Equipo Estándar:** El equipo estándar para la limpieza del agujero, está formado por cepillos de alambre de acero y boquillas de aire, está descrito en la Figura 6 de este reporte.

**3.2.2.2 Sistema Hilti Safe-Set™:** El Hilti Safe-Set™ con el Hilti HIT-HY 200 V3 consiste en uno de los siguientes:

- Para las varillas de anclaje Hilti HIT-Z e HIT-Z-R, después de la perforación del agujero no se requiere la limpieza del agujero, excepto si el agujero es perforado con una broca corona de diamante.
- Para los elementos descritos en las Secciones 3.2.4.2 hasta 3.2.4.4 y Sección 3.2.5, debe usarse la broca hueca de carburo Hilti TE-CD o TE-YD con una cabeza de perforación de carburo que cumple con ANSI B212.15. Se usa en conjunto con una aspiradora Hilti con un valor mínimo para la tasa máxima de flujo volumétrico de 129 CFM (61 l/s), la broca Hilti TE-CD o TE-YD eliminará el polvo de la perforación, limpiando automáticamente el agujero.

### 3.2.3 Equipo para la Preparación del Agujero:

**3.2.3.1 Sistema Hilti Safe-Set™: Herramienta de desbaste TE-YRT:** Para los elementos descritos en las Secciones 3.2.5.2 hasta 3.2.5.4 y en las Tablas 12, 13, 15, 18, 19, 21, 24, 25, 28 y 29, la herramienta de desbaste Hilti TE-YRT con una cabeza de desbaste de carburo se usa para la preparación del agujero en conjunto con agujeros perforados con broca corona de diamante como se muestra en la Sección 4.1.4.2 de este reporte.

**3.2.4 Aplicadores:** Hilti HIT-HY 200 V3 debe aplicarse con aplicadores manuales o eléctricos provistos por Hilti.

### 3.2.5 Elementos de Anclaje:

**3.2.5.1 Varillas de Anclaje Hilti HIT-Z e HIT-Z-R:** Las varillas de anclaje Hilti HIT-Z e HIT-Z-R tienen forma cónica en la sección empotrada y una sección roscada encima de la superficie del concreto. Las propiedades mecánicas de las varillas de anclaje Hilti HIT-Z e HIT-Z-R están provistas en la Tabla 2. Las varillas están disponibles en los diámetros que se muestran en la Tabla 7 y Figura 1. Las varillas de anclaje Hilti HIT-Z se producen de acero al carbono y están equipados con un recubrimiento de zinc galvanizado de 0.005-milímetros de espesor (5 µm). Las varillas de anclaje Hilti HIT-Z-R están fabricadas con acero inoxidable grado 316.

**3.2.5.2 Varillas Roscadas de Acero:** Las varillas roscadas de acero deben estar limpias, varillas de acero roscado continuo (de roscado completo) en diámetros como se describe en las Tablas 11 y 17 y en la Figura 1 de este reporte. La información de diseño de acero para grados comunes de varillas roscadas de acero esta provista en la Tabla 3. Las varillas roscadas de acero al carbono deben equiparse con un recubrimiento de zinc galvanizado de 0.0002-pulgadas de espesor (0.005 mm) que cumple con ASTM B633 SC 1 o debe ser galvanizado en caliente que cumpla con ASTM A153, Clase C o D. Las varillas roscadas de acero inoxidable deben cumplir con ASTM F593 o ISO 3506 A4. Las varillas roscadas de acero deben ser rectas y sin muescas u otros defectos en toda su longitud. Los extremos se pueden estampar con marcas de identificación y el extremo empotrado puede ser corte recto o corte en diagonal a una punta de cincel.

**3.2.5.3 Barras de Refuerzo de Acero para uso en Aplicaciones de Anclaje Post-Instalado:** Las barras de refuerzo de acero son barras corrugadas como se describe

en la Tabla 4 de este reporte. Las Tablas 11A, 17 y 23 y la Figura 1 resumen los rangos de tamaño de las barras de refuerzo. Las partes empotradas de las barras de refuerzo deben ser rectas y sin cascarillas de laminación, óxido, lodo, aceite y otros recubrimientos (distintos del zinc) que puedan afectar la adherencia del adhesivo. Las barras de refuerzo no deben doblarse después de la instalación, excepto cuando se hace de acuerdo a lo establecido en ACI 318-19 Sección 26.6.3.2(b), ACI 318-14 Sección 26.6.3.1(b) o ACI 318-11 Sección 7.3.2, según aplique, con la condición adicional de que las barras deben doblarse en frío; no está permitido el calentamiento de las barras para facilitar la flexión en campo.

**3.2.5.5 Insertos Hilti HIS-N y HIS-RN:** Los insertos Hilti HIS-N y HIS-RN tiene un perfil en la superficie externa y están roscados por dentro. Las propiedades mecánicas de los insertos Hilti HIS-N y HIS-RN están provistas en la Tabla 5. Los insertos están disponibles en los diámetros y longitudes que se muestran en la Tabla 27 y Figura 1. Los insertos Hilti HIS-N se producen del acero al carbono y están equipados con un recubrimiento de zinc galvanizado de 0.005-milímetros de espesor (5 µm) que cumple con ASTM B633 SC 1. Los insertos Hilti HIS-RN de acero inoxidable están fabricados con acero X5CrNiMo17122 K700 de acuerdo con DIN 17440. Las especificaciones para tipos comunes de tornillos que se pueden usar junto con los insertos Hilti HIS-N y HIS-RN están provistas en la Tabla 6. El grado del tornillo y el tipo de material (carbono, inoxidable) debe corresponder con el del inserto. Los factores de reducción de resistencia,  $\phi$ , correspondientes a los elementos de acero frágiles deben ser usados para los insertos Hilti HIS-N y HIS-RN.

**3.2.5.6 Ductilidad:** De acuerdo con ACI 318-19 y ACI 318-14 2.3 o ACI 318-11 D.1, según aplique, para que un elemento de acero se considere dúctil, la prueba de elongación debe ser al menos de 14 por ciento y la reducción de área debe ser al menos 30 por ciento. Los elementos de acero con una elongación probada de menos de 14 por ciento o una reducción de área de menos de 30 por ciento, o ambas, se consideran frágiles. Los valores para diferentes materiales de acero están provistos en las Tablas 2, 3 y 6 de este reporte. Cuando los valores no son conformes o los declarados, el acero debe considerarse frágil.

**3.2.6 Barras de Refuerzo de Acero para Uso en Conexiones de Barras de Refuerzo Post-Instaladas:** Las barras de refuerzo de acero usadas en conexiones de barras de refuerzo post-instaladas son barras corrugadas (barra de refuerzo) como se representa en las Figuras 2 y 3. Las Tablas 30, 31, 32, y la Figura 6 resumen los rangos de tamaño de las barras de refuerzo. Las porciones empotradas de las barras de refuerzo deben ser rectas y sin cascarillas de laminación, óxido, lodo, aceite y otros recubrimientos que puedan afectar la adherencia del adhesivo. Las barras de refuerzo no deben doblarse después de la instalación, excepto cuando se hace de acuerdo a lo establecido en la Sección 26.6.3.2(b) de ACI 318-19, Sección 26.6.3.1(b) de ACI 318-14 o Sección 7.3.2 de ACI 318-11, según aplique, con la condición adicional de que las barras deben doblarse en frío y no está permitido el calentamiento de las barras para facilitar la flexión en campo.

### 3.3 Concreto:

El concreto de densidad normal debe cumplir con las Secciones 1903 y 1905 del IBC, según aplique. La resistencia especificada a la compresión del concreto debe ser de 2,500 psi a 8,500 psi (17.2 MPa a 58.6 MPa).

**4.0 DISEÑO E INSTALACIÓN**

**4.1 Diseño por Resistencia de Anclajes Post-instalados:**

Para los parámetros de diseño de los elementos específicos instalados consulte la Tabla 1, y la tabla para determinar el diseño de esfuerzo de adherencia o resistencia al arrancamiento aplicable consulte la Sección 4.1.4.

**4.1.1 General:** La resistencia de diseño de los anclajes de acuerdo con el IBC 2021, así como con el IRC 2021, debe determinarse de acuerdo con ACI 318-19 y este reporte. La resistencia de diseño de los anclajes de acuerdo con el IBC 2018 y 2015 y el IRC 2018 y 2015 debe determinarse de acuerdo con ACI 318-14 y con este reporte. La resistencia de diseño de los anclajes de acuerdo con el IBC 2012, así como con el IRC 2012 debe determinarse de acuerdo con ACI 318-11 y con este reporte.

Los parámetros de diseño están basados en ACI 318-19 para uso con el IBC 2021, ACI 318-14 para uso con el IBC 2018 y 2015, y en ACI 318-11 para su uso con el IBC 2012 a menos que se indique lo contrario en las Secciones 4.1.1 a 4.1.11 de este reporte.

El diseño por resistencia de los anclajes debe cumplir con ACI 318-19 17.5.1.2 o ACI 318-14 17.3.1 o ACI 318-11 D.4.1 según aplique, excepto como es requerido en ACI 318-19 17.10 o ACI 318-14 17.2.3 o ACI 318-11 D.3.3, según aplique.

Los parámetros de diseño están provistos de la Tabla 7 hasta la Tabla 26. Los factores de reducción de resistencia,  $\phi$ , como se proveen en ACI 318-19 17.5.3, ACI 318-14 17.3.3 o ACI 318-11 D.4.3, según aplique, deben usarse para combinaciones de carga calculadas de acuerdo con la Sección 1605.1 del IBC 2021 o Sección 1605.2 del IBC 2018, 2015 y 2012 o ACI 318-19 y ACI 318-14 5.3 o ACI 318-11 9.2, según aplique. Los factores de reducción de resistencia,  $\phi$ , como se proveen en ACI 318-11 D.4.4 deben usarse para combinaciones de carga que se calculan de acuerdo con el Apéndice C de ACI 318-11.

**4.1.2 Resistencia Estática del Acero en Tensión:** La resistencia nominal estática del acero de un solo anclaje en tensión,  $N_{sa}$ , de acuerdo con ACI 318-19 17.6.1.2, ACI 318-14 17.4.1.2 o ACI 318-11 Sección D.5.1.2, según aplique, y los factores de reducción de resistencia relacionados,  $\phi$ , de acuerdo con ACI 318-19 17.5.3, ACI 318-14 17.3.3 o ACI 318-11 Sección D.4.3, según aplique, están provistas en las tablas descritas en la Tabla 1 para los tipos de elementos de anclaje incluidos en este reporte.

**4.1.3 Resistencia al Desprendimiento del Concreto Estático en Tensión:** La resistencia nominal estática al desprendimiento del concreto de un solo anclaje o de un grupo de anclajes en tensión,  $N_{cb}$  o  $N_{cbg}$ , debe calcularse de acuerdo con ACI 318-19 17.6.2, ACI 318-14 17.4.2 o ACI 318-11 D.5.2, según aplique, agregando lo siguiente:

La resistencia básica al desprendimiento del concreto de un solo anclaje en tensión,  $N_b$ , debe calcularse de acuerdo con ACI 318-19 17.6.2.2, ACI 318-14 17.4.2.2 o ACI 318-11 D.5.2.2, según aplique, utilizando los valores de  $k_{c,cr}$  y  $k_{c,uncr}$  como se describe en este reporte. Cuando los análisis indican que no hay fisuras de acuerdo con ACI 318-19 17.6.2.5, ACI 318-14 17.4.2.6 o ACI 318-11 D.5.2.6, según aplique,  $N_b$  debe calcularse utilizando  $k_{c,uncr}$  y  $\Psi_{c,N} = 1.0$ . Ver Tabla 1. Para anclajes en concreto de densidad liviana, ver ACI 318-19 17.2.4, ACI 318-14 17.2.6 o ACI 318-11 D.3.6, según aplique. El valor de  $f'_c$  que se usa para el cálculo debe limitarse a 8,000 psi (55 MPa) de acuerdo con ACI 318-19 17.3.1, ACI 318-14 17.2.7 o ACI 318-11 D.3.7, según aplique. La información adicional para determinar el esfuerzo nominal de adherencia en tensión esta provista en la Sección 4.1.4 de este reporte.

**4.1.4 Resistencia Estática de Adherencia/ Resistencia Estática a la Extracción en Tensión:**

**4.1.4.1 Resistencia Estática a la Extracción en Tensión: Varillas de Anclaje Hilti HIT-Z e HIT-Z-R:** La resistencia nominal estática a la extracción de un solo anclaje de acuerdo con ACI 318-19 17.6.3.1 y 17.6.3.2.1, ACI 318-14 17.4.3.1 y 17.4.3.2 o ACI 318-11 D.5.3.1 y D.5.3.2, según aplique, en concreto fisurado y no fisurado,  $N_{p,cr}$  y  $N_{p,uncr}$ , respectivamente, está provisto en la Tabla 10.  $\Psi_{c,P} = 1.0$ . para todos los casos de diseño.

Los valores de la resistencia a la extracción son una función de la resistencia a la compresión del concreto, sin importar si el concreto es fisurado o no fisurado, el método de perforación (roto martillo, incluyendo broca hueca Hilti, perforado con diamante) y las condiciones de instalación (seco o saturado con agua). La resistencia característica a la extracción resultante debe multiplicarse por el factor de reducción de resistencia asociado  $\phi_{hn}$  de la siguiente manera:

VARILLAS ROSCADAS HILTI HIT-Z Y HIT-Z-R				
MÉTODO DE PERFORACIÓN	TIPO DE CONCRETO	CONDICIONES PERMISIBLES DE LA INSTALACIÓN	RESISTENCIA A LA EXTRACCIÓN	FACTOR DE REDUCCIÓN DE RESISTENCIA ASOCIADO
Roto martillo (o Broca Hueca Hilti TE-CD o TE-YD) o Broca Corona de Diamante	No Fisurado	Seco	$N_{p,uncr}$	$\phi_d$
		Saturado con agua	$N_{p,uncr}$	$\phi_{ws}$
	Fisurado	Seco	$N_{p,cr}$	$\phi_d$
		Saturado con agua	$N_{p,cr}$	$\phi_{ws}$

La Sección 4.1.4.2 de este reporte presenta una tabla con la selección de diseño por resistencia a la extracción. Los factores de reducción de la resistencia para la determinación del esfuerzo de adherencia están provistos en las tablas descritas en la Tabla 1 de este reporte.

**4.1.4.2 Resistencia Estática de Adherencia en Tensión: Varillas Roscadas, Barras de Refuerzo de Acero, e insertos Hilti HIS-N y HIS-RN:** La resistencia nominal estática al esfuerzo de adherencia de un solo anclaje adhesivo o de un grupo de anclajes adhesivos en tensión,  $N_a$  o  $N_{ag}$ , debe calcularse de acuerdo con ACI 318-19 17.6.5, ACI 318-14 17.4.5 o ACI 318-11 D.5.5, según aplique. Los valores del esfuerzo de adherencia son una función de la resistencia a la compresión del concreto, sin importar si el concreto es fisurado o no fisurado, el rango de temperatura del concreto, y las condiciones de instalación (seco o saturado con agua). La resistencia característica de adherencia resultante debe multiplicarse por el factor de reducción de resistencia asociado  $\phi_{hn}$  de la siguiente manera:

MÉTODO DE PERFORACIÓN	TIPO DE CONCRETO	CONDICIONES PERMISIBLES DE LA INSTALACIÓN	ESFUERZO DE ADHERENCIA	FACTOR DE REDUCCIÓN DE RESISTENCIA ASOCIADO
Roto martillo (o Broca Hueca Hilti TE-CD o TE-YD) o Broca corona de Diamante con herramienta de desbaste Hilti TE-YRT	No Fisurado	Seco	$\tau_{k,uncr}$	$\phi_d$
		Saturado con agua	$\tau_{k,uncr}$	$\phi_{ws}$
	Fisurado	Seco	$\tau_{k,cr}$	$\phi_d$
		Saturado con agua	$\tau_{k,cr}$	$\phi_{ws}$
Roto martillo (o Broca Hueca Hilti TE-CD o TE-YD)	No Fisurado	Lleno de agua	$\tau_{k,uncr}$	$\phi_{wf}$
	Fisurado		$\tau_{k,cr}$	$\phi_{wf}$

Los factores de reducción de la resistencia para la determinación del esfuerzo de adherencia están descritos en la Tabla 1 de este reporte. Las modificaciones al esfuerzo de adherencia también se pueden hacer para una mayor resistencia a la compresión del concreto como se muestra en las notas al pie de las tablas del esfuerzo de adherencia.

**4.1.5 Resistencia Estática del Acero en Cortante:** La resistencia nominal estática del acero de un solo anclaje en cortante, gobernada por el acero,  $V_{sa}$ , de acuerdo con ACI 318-19 17.7.1.2, ACI 318-14 17.5.1.2 o ACI 318-11 D.6.1.2, según aplique y los factores de reducción de resistencia,  $\phi$ , de acuerdo con ACI 318-19 17.5.3, ACI 318-14 17.3.3 o ACI 318-11 D.4.3, según aplique, están provistos en las tablas descritas en la Tabla 1 para los tipos de elementos de anclaje incluidos en este reporte.

**4.1.6 Resistencia Estática al Arrancamiento del Concreto en Cortante:** La resistencia nominal estática al arrancamiento del concreto de un solo anclaje o de un grupo de anclajes en cortante,  $V_{cb}$  o  $V_{cbg}$ , debe calcularse de acuerdo con ACI 318-19 17.7.2, ACI 318-14 17.5.2 o ACI 318-11 D.6.2, según aplique, con base a la información que se provee en las tablas descritas en la Tabla 1. La resistencia básica al arrancamiento del concreto de un solo anclaje en cortante,  $V_b$ , debe calcularse de acuerdo con ACI 318-19 17.7.2.2, ACI 318-14 17.5.2.2 o ACI 318-11 D.6.2.2, según aplique, usando los valores de  $d$  que se proveen en las tablas como se describe en la Tabla 1 para el anclaje de acero correspondiente en lugar de  $d_a$  (IBC 2021, 2018, 2015 y 2012). Además,  $h_{ef}$  debe sustituirse por  $\ell_e$ . En ningún caso  $\ell_e$  debe exceder  $8d$ . El valor de  $f'_c$  debe limitarse a un máximo de 8,000 psi (55 MPa) de acuerdo con ACI 318-19 17.3.1, ACI 318-14 17.2.7 o ACI 318-11 D.3.7, según aplique.

**4.1.7 Resistencia Estática al Desprendimiento del Concreto en Cortante:** La resistencia nominal estática al desprendimiento del concreto de un solo anclaje o de un grupo de anclajes en cortante,  $V_{cp}$  o  $V_{cpb}$ , debe calcularse de acuerdo con ACI 318-19 17.7.3, ACI 318-14 17.5.3 o ACI 318-11 D.6.3, según aplique.

**4.1.8 Interacción de las Fuerzas de Tensión y de Cortante:** Para diseños que incluyen una combinación de tensión y de resistencia al cortante, la interacción entre las cargas de tensión y de cortante deben calcularse de acuerdo con ACI 318-19 17.8, ACI 318-14 17.6 o ACI 318-11 D.7, según aplique.

**4.1.9 Espesor Mínimo del Elemento,  $h_{min}$ , Separación entre Anclajes,  $s_{min}$  y Distancia al Borde,  $c_{min}$ :**

**4.1.9.1 Varillas de Anclaje Hilti HIT-Z e HIT-Z-R:** En sustitución de ACI 318-19 17.9.2, ACI 318-14 17.7.1 and 17.7.3 o ACI 318-11 D.8.1 y D.8.3, según aplique, los valores de  $s_{min}$  y  $c_{min}$  descritos en la Tabla 9 de este reporte deben observarse para el diseño e instalación del anclaje. El espesor mínimo del elemento,  $h_{min}$ , provisto en la Tabla 9 de este reporte debe observarse para el diseño e instalación del anclaje.

**4.1.9.2 Varillas Roscadas, Barras de Refuerzo de Acero e Insertos Hilti HIS-N y HIS-RN:** En sustitución de ACI 318-19 17.9.2, ACI 318-14 17.7.1 y 17.7.3 o ACI 318-11 D.8.1 y D.8.3, según aplique, los valores de  $c_{min}$  y  $s_{min}$  descritos en este reporte deben observarse para el diseño e instalación del anclaje. Así como, en sustitución de ACI 318-19 17.9.4, ACI 318-14 17.7.5 o ACI 318-11 D.8.5, según aplique, el espesor mínimo del elemento,  $h_{min}$ , descrito en este reporte debe observarse para el diseño e instalación del anclaje. Para anclajes adhesivos que permanecerán sin torque, aplica, ACI 318-19 17.9.3, ACI 318-14 17.7.4 o ACI 318-11 D.8.4, según aplique.

Para las distancias al borde  $c_{ai}$  y separación entre anclajes  $s_{ai}$ , el torque máximo  $T_{max}$  debe de cumplir con los siguientes requerimientos:

TORQUE MÁXIMO DE APRIETE REDUCIDO $T_{max,red}$ PARA DISTANCIAS AL BORDE $c_{ai} < (5 \times d_a)$		
DISTANCIA AL BORDE, $c_{ai}$	SEPARACIÓN MÍNIMA ENTRE ANCLAJES, $s_{ai}$	TORQUE MÁXIMO, $T_{max,red}$
1.75 pulg. (45 mm) $\leq c_{ai} < 5 \times d_a$	$5 \times d_a \leq s_{ai} < 16$ pulg.	$0.3 \times T_{max}$
	$s_{ai} \geq 16$ pulg. (406 mm)	$0.5 \times T_{max}$

**4.1.10 Distancia Crítica al Borde  $c_{ac}$  y  $\psi_{cp,Na}$ :**

**4.1.10.1 Varillas de Anclaje Hilti HIT-Z e HIT-Z-R:** En sustitución de ACI 318-19 17.9.5, ACI 318-14 17.7.6 o ACI 318-11 D.8.6, según aplique, para el cálculo de  $N_{cb}$  y  $N_{cbg}$  de acuerdo con ACI 318-19 17.6.2.6.1, ACI 318-14 17.4.2.7 o ACI 318-11 D.5.2.7, según aplique y la Sección 4.1.3 de este reporte, la distancia crítica al borde,  $c_{ac}$ , debe determinarse como sigue:

- i.  $c_{ac} = 1.5 \cdot h_{ef}$  para  $h/h_{ef} \geq 2.35$
- ii.  $c_{ac} = 3.5 \cdot h_{ef}$  para  $h/h_{ef} \leq 1.35$

Para las definiciones de  $h$  y  $h_{ef}$ , ver Figura 1.

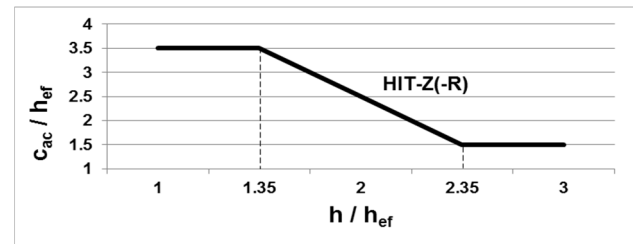

La interpolación lineal se permite para determinar la relación de  $c_{ac}/h_{ef}$  para los valores de  $h/h_{ef}$  entre 2.35 y 1.35 como se ilustra en el gráfico anterior.

**4.1.10.2 Varillas Roscadas, Barras de Refuerzo de Acero e Insertos Hilti HIS-N y HIS-RN:** El factor de modificación  $\psi_{cp,Na}$ , debe determinarse de acuerdo con ACI 318-19 17.6.5.5, ACI 318-14 17.4.5.5 o ACI 318-11 D.5.5.5, según aplique, excepto como se describe a continuación:

Para todos los casos donde  $c_{Na}/c_{ac} < 1.0$ ,  $\psi_{cp,Na}$  determinado por ACI 318-19 Ec. 17.6.5.5.1b, ACI 318-14 Ec. 17.4.5.5b o ACI 318-11 Ec. D-27, según aplique, no debe ser menor que  $c_{Na}/c_{ac}$ . Para todos los otros casos,  $\psi_{cp,Na}$  debe tomarse como 1.0.

La distancia crítica al borde,  $c_{ac}$  debe calcularse de acuerdo con la Ec. 17.6.5.5.1c para ACI 318-19, con la Ec. 17.4.5.5c para ACI 318-14 o Ec. D-27a para ACI 318-11, en sustitución de ACI 318-19 17.9.5, ACI 318-14 17.7.6 o ACI 318-11 D.8.6, según aplique.

$$c_{ac} = h_{ef} \cdot \left( \frac{\tau_{k,uncr}}{1160} \right)^{0.4} \cdot \left[ 3.1 - 0.7 \frac{h}{h_{ef}} \right]$$

(Ec. 17.6.5.5.1c para ACI 318-19, Ec. 17.4.5.5c para ACI 318-14 o Ec. D-27a para ACI 318-11)

donde

$\left[ \frac{h}{h_{ef}} \right]$  no debe ser mayor que 2.4; y

$\tau_{k,uncr}$  es el esfuerzo característico de adherencia en concreto no fisurado,  $h$  es el espesor del elemento, y  $h_{ef}$  es la profundidad del empotramiento.

$\tau_{k,uncr}$  no debe ser mayor a:

$$\tau_{k,uncr} = \frac{k_{uncr} \sqrt{h_{ef} f'_c}}{\pi d} \tag{Ec. (4-1)}$$

**4.1.11 Resistencia de Diseño en Categorías de Diseño Sísmico C, D, E y F:** En estructuras asignadas a las Categorías de Diseño Sísmico C, D, E o F de acuerdo con

el IBC o IRC, el diseño debe llevarse a cabo de acuerdo con ACI 318-19 17.10, ACI 318-14 17.2.3 o ACI 318-11 D.3.3, según aplique, excepto como se describe a continuación:

Las modificaciones al ACI 318-19 17.10 y ACI 318-14 17.2.3 deben de aplicarse bajo la Sección 1905.1.8 del IBC 2021, 2018 y 2015, según aplique. Para el IBC 2012, se debe omitir la Sección 19.5.1.9. La resistencia nominal del acero al cortante,  $V_{sa}$ , debe ajustarse por  $\alpha_{V,seis}$  como se provee en las tablas resumidas en la Tabla 1 para los tipos de elementos de anclaje que se incluyen en este reporte. Para la tensión, la resistencia nominal a la extracción  $N_{p,cr}$  o el esfuerzo de adherencia  $\tau_{cr}$  debe ajustarse por  $\alpha_{N,seis}$ . Ver las Tablas 10, 13, 14, 15, 16, 19, 20, 21, 22, 25, 26 y 29.

Como excepción al ACI 318-11 D.3.3.4.2:

Los anclajes diseñados para resistir fuerzas fuera de plano del muro con diseños de resistencia iguales a o superiores a la fuerza determinada de acuerdo con ecuaciones 12.11-1 o 12.14-10 de ASCE 7 debe considerarse que satisface el ACI 318-11 D.3.3.4.3 (d). Bajo ACI 318-11 D.3.3.4.3(d), en lugar de requerir la resistencia a la tensión de diseño del anclaje para cumplir los requerimientos de resistencia a la tensión de ACI 318-11 D.4.1.1, la resistencia a la tensión de diseño del anclaje debe calcularse con ACI 318-11 D.3.3.4.4.

Las siguientes excepciones se aplican a ACI 318-11 D.3.3.5.2:

1. Para calcular la resistencia al cortante en plano de los pernos de anclaje sujetando la solera de madera de muros portantes o muros no portantes de construcciones de madera de estructura liviana a fundaciones o muros de vástago de fundación, no es necesario calcular la resistencia al cortante en plano de acuerdo con ACI 318-11 D.6.2 y D.6.3, y no es necesario aplicar ACI 318-11.3.3.5.3 si se cumplen todos los siguientes puntos:

- 1.1. La resistencia al cortante en plano permisible del anclaje se determina de acuerdo con AF&PA NDS, Tabla 11E para valores de diseño lateral paralelos al grano.
- 1.2. El diámetro nominal máximo del anclaje es de  $5/8$  de pulgada (16 mm).
- 1.3. Los pernos de anclaje están empotrados en el concreto por lo menos 7 pulgadas (178 mm).
- 1.4. Los pernos de anclaje se colocan a un mínimo de  $1\ 3/4$  pulgadas (45 mm) del borde del concreto paralelamente a la longitud de la solera de madera.
- 1.5. Los pernos de anclaje se colocan a un mínimo de 15 diámetros del anclaje desde el borde del concreto perpendicular a la longitud de la solera de madera.
- 1.6. La solera tiene un espesor nominal de 2 pulgadas o 3 pulgadas.

2. Para el cálculo de la resistencia al cortante en plano de los pernos de anclaje sujetando elementos de acero formado en frío en muros portantes o muros no portantes de construcciones de estructura liviana a la fundación o muros sobre cimientos de fundación, la resistencia al cortante en plano no necesita calcularse de acuerdo con ACI 318-11 D.6.2 y D.6.3 y no es necesario aplicar ACI 318-11 D.3.3.5.3 si se cumplen todos los siguientes puntos:

- 2.1. El diámetro nominal máximo del anclaje es  $5/8$  de pulgada (16 mm).
- 2.2. Los pernos de anclaje están empotrados en el concreto por lo menos 7 pulgadas (178 mm).

2.3. Los anclajes se colocan a un mínimo de  $1\ 3/4$  pulgadas (45 mm) del borde del concreto paralelamente a la longitud del canal.

2.4. Los anclajes se colocan a un mínimo de 15 diámetros de anclaje desde el borde del concreto perpendicular a la longitud del canal.

2.5. El canal tiene un espesor designado de 33 mil a 68 mil.

La resistencia permisible al cortante en plano de los anclajes exentos, paralelos al borde del concreto puede determinarse de acuerdo con AISI S100 Sección E3.3.1.

3. En construcciones de estructuras livianas, muros portantes y muros no portantes, la resistencia al cortante de los anclajes de concreto menor que o igual a 1 pulgada [25 mm] de diámetro sujetando una solera o canal a la fundación o al muro de vástago de fundación, no necesitan cumplir con ACI 318-11 D.3.3.5.3(a) hasta (c) cuando la resistencia del diseño de los anclajes se determina de acuerdo con ACI 318-11 D.6.2.1(c).

**4.2 Diseño por Resistencia de Barras de Refuerzo Post-Instaladas:**

**4.2.1 General:** El diseño de la resistencia de barras de refuerzo corrugas post-instaladas debe determinarse de acuerdo con las reglas de ACI 318 y con este reporte para el desarrollo y empalme de barras de refuerzo pre-instaladas.

Los ejemplos de aplicaciones típicas del uso de barras de refuerzo post-instaladas se ilustran en la Figura 3 de este reporte.

**4.2.2 Determinación de la longitud de desarrollo de la barra  $l_d$ :** Los valores de  $l_d$  deben determinarse de acuerdo con los requerimientos de ACI 318 de la longitud de desarrollo y empalme de barras de refuerzo rectas pre-instaladas.

**Excepciones:**

- 1. Para barras de refuerzo post-instaladas sin recubrimiento y con recubrimiento de zinc (galvanizadas), el factor  $\Psi_e$  debe de tomarse como 1.0. Para todos los demás casos, se deben aplicar los requerimientos de ACI 318-19 25.4.2.5, ACI 318-14 25.4.2.4 o ACI 318-11 Sección 12.2.4 (b).
- 2. Cuando se usen métodos alternativos para calcular la longitud de desarrollo (por ejemplo, teoría de anclaje), generalmente se aplican los factores aplicables para anclajes post-instalados.

**4.2.3 Recubrimiento Mínimo de Concreto,  $c_{c,min}$ , Distancia Mínima al Borde de Concreto,  $c_{b,min}$ , Separación Mínima,  $s_{b,min}$ :** Para barras de refuerzo post-instaladas, no hay límite en el espesor mínimo del elemento. En general, se deben mantener todos los requerimientos en el recubrimiento del concreto y la separación aplicable entre las barras rectas pre-instaladas diseñadas de acuerdo con ACI 318.

Para barras de refuerzo post-instaladas a una profundidad de empotramiento,  $h_{ef}$ , mayor que 20d ( $h_{ef} > 20d$ ), el recubrimiento mínimo del concreto debe de ser el siguiente:

TAMAÑO DE LA BARRA DE REFUERZO	RECUBRIMIENTO MÍNIMO DEL CONCRETO, $c_{c,min}$
$d_b \leq \text{No. 6 (16mm)}$	$1\ 3/16 \text{ pulg. (30mm)}$
$\text{No. 6} < d_b \leq \text{No. 10 (16mm} < d_b \leq 32\text{mm)}$	$1\ 9/16 \text{ pulg. (40mm)}$

Se aplican los siguientes requerimientos para la distancia al borde y separación mínima para  $h_{ef} > 20d$ :

Distancia mínima al borde requerida para barras de refuerzo post-instaladas (medido desde el centro de la barra):

$$C_{b,min} = d_o/2 + C_{c,min}$$

Separación mínima requerida de centro a centro entre barras post-instaladas:

$$S_{b,min} = d_o + C_{c,min}$$

Separación mínima requerida de centro a centro desde el refuerzo existente (paralelo):

$$S_{b,min} = d_b/2 \text{ (refuerzo existente)} + d_o/2 + C_{c,min}$$

**4.2.4 Resistencia de diseño en Categorías de Diseño Sísmico C, D, E y F:** En estructuras asignadas a las Categorías Sísmicas C, D, E o F de acuerdo con el IBC o IRC, el diseño de barras de refuerzo rectas post-instaladas debe tomar en cuenta las disposiciones del Capítulo 18 de ACI 318-19 o ACI 318-14 o Capítulo 21 de ACI 318-11, según aplique.

### 4.3 Instalación:

Los parámetros de instalación están ilustrados en la Figura 1. La instalación debe cumplir con ACI 318-19 26.7.2, ACI 318-14 17.8.1 y 17.8.2 o ACI 318-11 D.9.1 y D.9.2, según aplique. Las ubicaciones de los anclajes y barras de refuerzo post-instaladas deben cumplir con este reporte y con los planos y especificaciones aprobadas por el oficial a cargo del código. La instalación de los Sistemas de Anclajes Adhesivos Hilti HIT-HY 200 V3 y de Barras de Refuerzo Post-Instaladas debe cumplir con las instrucciones de instalación (MPII) impresas por el fabricante que se incluyen en cada paquete como lo muestra la Figura 6 de este reporte. Las MPII contienen los requerimientos adicionales para las combinaciones de la profundidad del agujero, diámetro, tipo de broca y herramientas aplicadoras.

### 4.4 Inspección Especial:

Se debe realizar inspecciones especiales periódicas cuando se requiera de acuerdo con la Sección 1705.1.1 y Tabla 1705.3 del IBC 2021, 2018, 2015 y 2012, y este reporte. El inspector especial debe estar presente en el sitio inicialmente durante la instalación del anclaje o de la barra de refuerzo post-instalada para verificar el tipo y dimensiones del anclaje o de la barra de refuerzo, tipo de concreto, resistencia a la compresión del concreto, identificación del adhesivo y la fecha de expiración, las dimensiones de la perforación, los procedimientos de limpieza de la perforación, separaciones, distancias al borde, espesor del concreto, empotramiento del anclaje o de la barra de refuerzo post-instalada, torque de ajuste y cumplimiento con las instrucciones de instalación impresas del fabricante.

El inspector especial debe verificar la instalación inicial de cada tipo y tamaño de anclaje o barra de refuerzo post-instalada por parte del personal de la construcción en sitio. Las instalaciones subsecuentes del mismo tipo y tamaño de anclaje o barra de refuerzo post-instalada llevadas a cabo por el mismo personal de la construcción pueden realizarse en ausencia del inspector especial. Cualquier cambio en el anclaje o en la barra de refuerzo que se va instalar o en el personal que realiza la instalación, requiere una inspección especial. Para instalaciones continuas a lo largo de un periodo extendido, el inspector especial debe hacer inspecciones regulares para confirmar el correcto manejo e instalación del producto.

Las inspecciones especiales continuas de anclajes adhesivos o de barras de refuerzo post-instaladas en orientaciones horizontales o inclinadas hacia arriba para resistir cargas de tensión sostenidas deben de realizarse de acuerdo con ACI 318-19 26.13.3.2e y 26.7.1(j), ACI 318-14 17.8.2.4, 26.7.1(h) y 26.13.3.2(c) o ACI 318-11 D.9.2.4, según aplique.

De acuerdo al IBC, deben observarse los requerimientos adicionales como se indican en las Secciones 1705, 1706, y 1707, según aplique.

## 5.0 CONDICIONES DE USO

El Sistema de Anclajes Adhesivos Hilti HIT-HY 200 V3 y el Sistema de Barras de Refuerzo Post-Instaladas descritos en este reporte cumple o son una alternativa adecuada a lo que se especifica en los códigos mencionados en las Sección 1 de este reporte, sujeto a las siguientes condiciones:

- 5.1** Los anclajes adhesivos Hilti HIT-HY 200 V3 y las barras de refuerzo post-instaladas deben instalarse de acuerdo con las instrucciones de instalación impresas proporcionadas por el fabricante (MPII) que se incluyen en el paquete del adhesivo y se muestran en la Figura 6 de este reporte.
- 5.2** Los anclajes y las barras de refuerzo post-instaladas deben instalarse en concreto de densidad normal, fisurado o no fisurado, con una resistencia especificada a la compresión  $f'_c = 2,500$  psi a 8,500 psi (17.2 MPa a 58.6 MPa).
- 5.3** Los valores de  $f'_c$  que se usen para fines de cálculo no deben exceder 8,000 psi (55.1 MPa) excepto como se indica en las Secciones 4.2.2 y 4.2.4 de este reporte.
- 5.4** El concreto debe haber alcanzado su diseño por resistencia mínimo antes de la instalación de los anclajes adhesivos.
- 5.5** Los anclajes y las barras de refuerzo post-instaladas deben instalarse en materiales con base de concreto en agujeros preperforados de acuerdo a las instrucciones de la Figura 6, con brocas de punta de carburo elaboradas con los rangos de las dimensiones máximas y mínimas de las brocas especificadas en ANSI B212.15-1994. Las varillas de anclaje Hilti HIT-Z (-R) pueden instalarse en agujeros preperforados con brocas corona de diamante. Las varillas roscadas, barras de refuerzo, e insertos Hilti HIS-(R)N se pueden instalar en agujeros preperforados usando brocas corona de diamante y raspados con la herramienta de desbaste Hilti TE-YRT como se detalla en la Figura 6.
- 5.6** Las cargas que se apliquen al anclaje deben ajustarse de acuerdo con la Sección 1605.1 del IBC 2021 o Sección 1605.2 del IBC 2018, 2015 y 2012 para diseño de resistencia y de acuerdo con la Sección 1605.1 del IBC 2021 o Sección 1605.3 del IBC 2018, 2015, y 2012 para diseño por tensión admisible.
- 5.7** Los anclajes adhesivos Hilti HIT-HY 200 V3 y las barras de refuerzo post-instaladas son reconocidas porque se usan para resistir cargas a corto y largo plazo, incluyendo cargas de viento y sísmicas, sujetos a las condiciones de este reporte.
- 5.8** En estructuras asignadas a las Categorías de Diseño Sísmico C, D, E o F de acuerdo con el IBC o IRC, la resistencia del anclaje debe ajustarse de acuerdo con la Sección 4.1.11 de este reporte, y las barras de refuerzo post-instaladas deben cumplir con la sección 4.2.4 de este reporte.

- 5.9** Se permite la instalación de anclajes adhesivos Hilti HIT-HY 200 V3 y barras de refuerzo post-instaladas en concreto que esta fisurado o que se espera que se fisure durante la vida útil del anclaje, sujeto a las condiciones de este reporte.
- 5.10** Los valores de diseño de resistencia deben establecerse de acuerdo con la Sección 4.1 de este reporte.
- 5.11** La longitud de desarrollo y empalme de barras de refuerzo post-instaladas se establece de acuerdo con la Sección 4.2 de este reporte.
- 5.12** La separación mínima entre anclajes y la distancia al borde, así como el espesor mínimo del elemento deben cumplir con los valores descritos en este reporte.
- 5.13** La distancia entre las barras de refuerzo post-instaladas, el espesor mínimo del elemento y la distancia del recubrimiento deben cumplir con lo dispuesto en ACI 318 para barras pre-instaladas y con la Sección 4.2.3 de este reporte.
- 5.14** Los cálculos y detalles que demuestren el cumplimiento con este reporte deben enviarse a la autoridad competente antes de la instalación del anclaje. Los cálculos y detalles deben prepararse por un diseñador profesional registrado cuando así lo requieran los estatutos de la jurisdicción donde el proyecto se va a construir.
- 5.15** Los anclajes y las barras de refuerzo post-instaladas no están permitidas para soportar construcciones resistentes al fuego. Cuando el código no lo prohíba, se permite la instalación de anclajes adhesivos Hilti HIT-HY 200 V3 y de barras de refuerzo post-instaladas en construcciones resistentes al fuego siempre y cuando se cumpla por lo menos una de las siguientes condiciones:
- Los anclajes y barras de refuerzo post-instaladas se usan únicamente para resistir fuerzas del viento o sísmicas.
  - Los anclajes y las barras de refuerzo post-instaladas que soportan elementos estructurales portantes con cargas por gravedad se encuentran dentro de una envolvente resistente al fuego o membrana resistente al fuego, están protegidos por materiales aprobados resistentes al fuego, o han sido evaluados para resistir la exposición al fuego de acuerdo con normas reconocidas.
  - Los anclajes y las barras de refuerzo post-instaladas se usan para soportar elementos no estructurales.
- 5.16** Debido a que los criterios de aceptación de ICC-ES para determinar el funcionamiento de los anclajes adhesivos y las barras de refuerzo post-instaladas sujetos a fatiga o cargas de impacto no están disponibles en este momento, el uso de estos anclajes bajo estas condiciones queda fuera del alcance de este reporte.
- 5.17** El uso de varillas roscadas de acero al carbono recubiertas de zinc o barras de refuerzo de acero se limita a ubicaciones interiores secas.
- 5.18** El uso de varillas de acero al carbono galvanizadas en caliente o de acero inoxidable está permitido en exteriores o entornos húmedos.
- 5.19** Los materiales de anclaje de acero que se encuentren en contacto con madera tratada con preservativos o con retardadores de fuego deben ser de acero inoxidable o de acero al carbono recubierto de zinc. Los pesos mínimos de recubrimiento para acero recubierto de zinc deben cumplir con ASTM A153.
- 5.20** Debe llevarse a cabo inspección especial periódica de acuerdo con la Sección 4.4 de este reporte. Para anclajes y de las barras de refuerzo post-instaladas instaladas en orientaciones horizontales o inclinadas hacia arriba para resistir cargas de tensión sostenida deben llevarse a cabo inspecciones especiales continuas de acuerdo con la Sección 4.4 de este reporte.
- 5.21** La instalación de anclajes y barras de refuerzo post-instaladas orientados horizontalmente o inclinados hacia arriba para resistir cargas de tensión sostenidas debe llevarla a cabo personal certificado por un programa de certificación aplicable de acuerdo con ACI 318-19 26.7.2(e), ACI 318-14 17.8.2.2 o 17.8.2.3, o ACI 318-11 D.9.2.2 o D.9.2.3, según aplique.
- 5.22** Los anclajes adhesivos Hilti HIT-HY 200 V3 y las barras de refuerzo post-instaladas pueden ser usadas para resistir fuerzas de tensión y de cortante en el piso, paredes e instalaciones sobre cabeza únicamente si la instalación es en concreto con una temperatura entre 14°F y 104°F (-10°C y 40°C) para varillas roscadas, barras de refuerzo e insertos Hilti HIS-(R)N, o entre 41°F y 104°F (5°C y 40°C) para varillas de anclaje Hilti HIT-Z-(R). (Para barras de refuerzo post-instaladas con profundidad de empotramiento mayor de 20d consulte las limitaciones de temperatura adicional en las MPII como se proporciona en la Figura 6 de este reporte). Las instalaciones superiores para agujeros con diámetros mayores de  $\frac{7}{16}$  pulgadas o 10mm requieren el uso de conectores de pistón (HIT-SZ, -IP) durante la inyección en la parte posterior del agujero, los agujeros con diámetro de  $\frac{7}{16}$  pulgadas se pueden inyectar directamente en la parte posterior del agujero con el uso de manguera de extensión en el extremo de la boquilla. Los anclajes o barras de refuerzo post-instaladas deben sostenerse hasta que el curado este completo (es decir, con cuñas Hilti HIT-OHW u otros medios adecuados). Cuando se utilizan dispositivos de restricción temporales, su uso no debe perjudicar la resistencia al cortante. Las instalaciones en las temperaturas del concreto por debajo de 32°F requieren que el adhesivo este condicionado a una temperatura mínima de 32°F.
- 5.23** Los anclajes y las barras de refuerzo post-instaladas, cuando se instalan a temperaturas menores de 40°F, no deben de ser usadas en aplicaciones donde la temperatura del concreto pueda elevarse de 40°F hasta 80°F o mayor dentro de un período de 12 horas. Dichas aplicaciones pueden incluir, pero no se limitan al anclaje de los sistemas de la edificación de fachadas y otras aplicaciones sujetas a la exposición directa al sol.
- 5.24** Los adhesivos Hilti HIT-HY 200-A V3 y Hilti HIT-HY 200-R V3 se fabrican por Hilti GmbH, Kaufering, Alemania, bajo un programa de control de calidad sujeto a inspecciones por parte de ICC-ES.
- 5.25** Las varillas Hilti HIT-Z e HIT-Z-R se fabrican por Hilti AG, Schaan, Liechtenstein, bajo un programa de control de calidad sujeto a inspecciones por parte de ICC-ES.
- 5.26** Los insertos Hilti HIS-N y HIS-RN se fabrican por Hilti (China) Ltd., Guangdong, China, bajo un programa de control de calidad sujeto a inspecciones por parte de ICC-ES.

## 6.0 EVIDENCIA ENVIADA

Los datos están de acuerdo con los Criterios de Aceptación para Anclajes Adhesivos Post-Instalados en Concreto (AC308) de ICC-ES, con fecha de junio de 2019, revisado editorialmente en febrero de 2021 en los que se incorporan los requerimientos de ACI 355.4-11 y ACI 355.4-19, y la Tabla 3.8 para la evaluación de barras de refuerzo post-instaladas.

## 7.0 IDENTIFICACIÓN

- 7.1 El etiquetado del producto debe incluir el nombre del titular del reporte o listado y la marca de conformidad ICC-ES. El listado o número de reporte de evaluación (ICC-ES ESR-4868) puede usarse en lugar de la marca de conformidad. El adhesivo Hilti HIT-HY 200 A V3 y Hilti HIT HY 200 R V3 se identifica por el empaque etiquetado con el nombre del fabricante (Hilti Corp.) y dirección, nombre del producto, número de lote, fecha de expiración y número del reporte de evaluación (ESR-4868).
- 7.2 Las varillas Hilti HIT-Z e HIT-Z-R se identifican mediante etiquetas en el empaque que llevan el nombre del fabricante (Hilti Corp.) y dirección, nombre de anclaje y número del reporte de evaluación (ESR-4868).

7.3 Los insertos Hilti HIS-N y HIS-RN se identifican mediante etiquetas en el empaque que llevan el nombre del fabricante (Hilti Corp.) y dirección, nombre y tamaño del anclaje, y número del reporte de evaluación (ESR-4868).

7.4 Las varillas roscadas, tuercas, arandelas y barras de refuerzo corrugadas son elementos estándar y deben cumplir con las especificaciones nacionales e internacionales aplicables

7.5 La información de contacto del titular del reporte es la siguiente:

**HILTI, INC.**  
**7250 DALLAS PARKWAY, SUITE 1000**  
**PLANO, TEXAS 75024**  
**(800) 879-8000**  
[www.hilti.com](http://www.hilti.com)  
[HiltiTechEng@us.hilti.com](mailto:HiltiTechEng@us.hilti.com)



**VARILLA DE ANCLAJE HILTI HIT-Z Y HIT-Z-R**

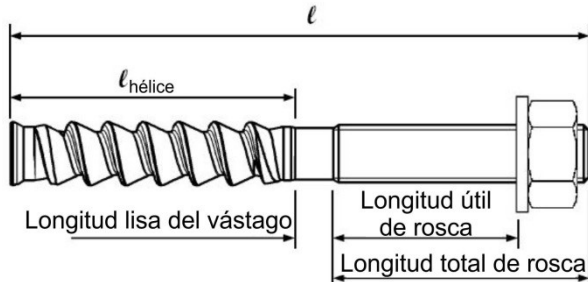
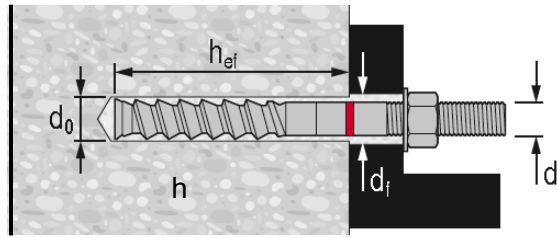

**VARILLA ROSCADA HIT-Z Y HIT-Z-R FRACCIONAL**

Ø d <sub>0</sub> [pulg.]	Ø d <sub>0</sub> [pulg.]	h <sub>ef</sub> [pulg.]	T <sub>inst</sub> [pie-lb]		T <sub>inst</sub> [Nm]	
			HIT-Z	HIT-Z-R	HIT-Z	HIT-Z-R
3/8	7/16	2 3/8 ... 4 1/2	15	30	20	40
1/2	9/16	2 3/4 ... 6	30	65	40	90
5/8	3/4	3 3/4 ... 7 1/2	60	125	80	170
3/4	7/8	4 ... 8 1/2	110	165	150	220

**VARILLA ROSCADA HIT-Z Y HIT-Z-R MÉTRICA**

Ø d [mm]	Ø d <sub>0</sub> [mm]	h <sub>nom</sub> [mm]	T <sub>inst</sub> [Nm]	
			HIT-Z	HIT-Z-R
M10	12	60...120	25	55
M12	14	70...144	40	75
M16	18	96...192	80	155
M20	22	100...220	150	215

Nombre y tamaño	l Longitud de anclaje		l <sub>hélice</sub> Longitud de hélice		Longitud lisa del vástago		Longitud total de rosca		Longitud útil de rosca	
	pulg.	(mm)	pulg.	(mm)	pulg.	(mm)	pulg.	(mm)	pulg.	(mm)
HIT-Z(-R) 3/8"x3 3/8"	3 3/8	(85)	2 1/4	(57)	3/8	(6)	1 3/16	(21)	5/16	(8)
HIT-Z(-R) 3/8" x 4 3/8"	4 3/8	(111)	2 1/4	(57)	5/16	(8)	1 13/16	(46)	1 5/16	(33)
HIT-Z(-R) 3/8" x 5 1/8"	5 1/8	(130)	2 1/4	(57)	5/16	(8)	2 9/16	(65)	2 1/16	(52)
HIT-Z(-R) 3/8" x 6 3/8"	6 3/8	(162)	2 1/4	(57)	5/16	(8)	3 13/16	(97)	3 5/16	(84)
HIT-Z(-R) 1/2" x 4 1/2"	4 1/2	(114)	2 1/2	(63)	5/16	(8)	1 11/16	(43)	1	(26)
HIT-Z(-R) 1/2" x 6 1/2"	6 1/2	(165)	2 1/2	(63)	5/16	(8)	3 11/16	(94)	3 1/16	(77)
HIT-Z(-R) 1/2" x 7 3/4"	7 3/4	(197)	2 1/2	(63)	5/16	(8)	4 15/16	(126)	4 5/16	(109)
HIT-Z(-R) 5/8" x 6"	6	(152)	3 5/8	(92)	7/16	(11)	1 15/16	(49)	1 1/8	(28)
HIT-Z(-R) 5/8" x 8"	8	(203)	3 5/8	(92)	7/16	(11)	3 5/16	(100)	3 1/8	(79)
HIT-Z(-R) 5/8" x 9 1/2"	9 1/2	(241)	3 5/8	(92)	1 15/16	(49)	3 15/16	(100)	3 1/8	(79)
HIT-Z(-R) 3/4" x 6 1/2"	6 1/2	(165)	4	(102)	5/16	(8)	2	(51)	1	(26)
HIT-Z(-R) 3/4" x 8 1/2"	8 1/2	(216)	4	(102)	7/16	(12)	4	(102)	3 1/16	(77)
HIT-Z(-R) 3/4" x 9 3/4"	9 3/4	(248)	4	(102)	1 11/16	(44)	4	(102)	3 1/16	(77)
HIT-Z(-R) M10x95	3 3/4	(95)	1 15/16	(50)	1 1/16	(18)	1 1/8	(27)	9/16	(14)
HIT-Z(-R) M10x115	4 1/2	(115)	1 15/16	(50)	1 1/16	(18)	1 7/8	(47)	1 5/16	(34)
HIT-Z(-R) M10x135	5 5/16	(135)	1 15/16	(50)	1 1/16	(18)	2 5/8	(67)	2 1/8	(54)
HIT-Z(-R) M10x160	6 5/16	(160)	1 15/16	(50)	1 1/16	(18)	3 5/8	(92)	3 1/8	(79)
HIT-Z(-R) M12x105	4 1/8	(105)	2 3/8	(60)	5/16	(8)	1 1/2	(37)	1 3/16	(21)
HIT-Z(-R) M12x140	5 1/2	(140)	2 3/8	(60)	5/16	(8)	2 7/8	(72)	2 3/16	(56)
HIT-Z(-R) M12x155	6 1/8	(155)	2 3/8	(60)	5/16	(8)	3 3/8	(87)	2 13/16	(71)
HIT-Z(-R) M12x196	7 3/4	(196)	2 3/8	(60)	5/16	(8)	5	(128)	4 7/16	(112)
HIT-Z(-R) M16x155	6 1/8	(155)	3 11/16	(93)	7/16	(11)	2	(51)	1 3/16	(30)
HIT-Z(-R) M16x175	6 7/8	(175)	3 11/16	(93)	7/16	(11)	2 13/16	(71)	1 15/16	(50)
HIT-Z(-R) M16x205	8 1/16	(205)	3 11/16	(93)	7/16	(11)	4	(101)	3 1/8	(80)
HIT-Z(-R) M16x240	9 7/16	(240)	3 11/16	(93)	1 1/4	(32)	4 1/2	(115)	3 11/16	(94)
HIT-Z(-R) M20x215	8 1/2	(215)	3 15/16	(100)	1/2	(13)	4	(102)	3 1/16	(78)
HIT-Z(-R) M20x250	9 13/16	(250)	3 15/16	(100)	1 7/8	(48)	4	(102)	3 1/16	(78)

FIGURA 1—PARÁMETROS DE INSTALACIÓN PARA ANCLAJES ADHESIVOS POST-INSTALADOS

**REFUERZO CORRUGADO**

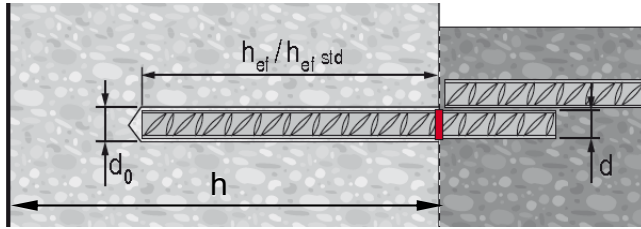

**BARRA DE REFUERZO US**

d	Ø d <sub>0</sub> [pulg]	h <sub>ef</sub> std [pulg]	h <sub>ef</sub> [pulg]
#3	1/2	3 3/8	2 3/8...7 1/2
#4	5/8	4 1/2	2 3/4...10
#5	3/4	5 5/8	3 1/8...12 1/2
#6	7/8	6 3/4	3 1/2...15
#7	1	7 7/8	3 1/2...17 1/2
#8	1 1/8	9	4...20
#9	1 3/8	10 1/8	4 1/2...22 1/2
#10	1 1/2	11 1/4	5...25

**BARRA DE REFUERZO CANADIENSE**

d	Ø d <sub>0</sub> [pulg]	h <sub>ef</sub> std [mm]	h <sub>ef</sub> [mm]
10 M	5/16	115	70...226
15 M	3/4	145	80...320
20 M	1	200	90...390
25 M	1 1/4	230	101...504
30 M	1 1/2	260	120...598

**BARRA DE REFUERZO EUROPEA**

Ø d [mm]	Ø d <sub>0</sub> [mm]	h <sub>ef</sub> std [mm]	h <sub>ef</sub> [mm]
10	14	90	60...200
12	16	110	70...240
14	18	125	75...280
16	20	125	80...320
20	25	170	90...400
25	32	210	100...500
28	35	270	112...560
32	40	300	128...640

**VARILLA ROSCADA**

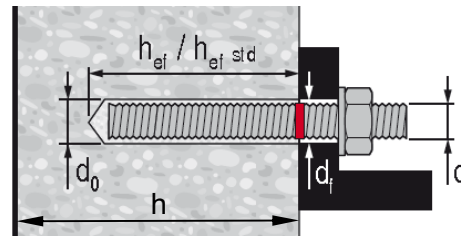

**VARILLA ROSCADA FRACCIONAL**

Ø d [pulg]	Ø d <sub>0</sub> [pulg]	h <sub>ef</sub> std [pulg]	h <sub>ef</sub> [pulg]	T <sub>max</sub> [pie-lb]	T <sub>max</sub> [Nm]
3/8	7/16	3 3/8	2 3/8...7 1/2	15	20
1/2	9/16	4 1/2	2 3/4...10	30	41
5/8	3/4	5 5/8	3 1/8...12 1/2	60	81
3/4	7/8	6 3/4	3 1/2...15	100	136
7/8	1	7 7/8	3 1/2...17 1/2	125	169
1	1 1/8	9	4...20	150	203
1 1/4	1 3/8	11 1/4	5...25	200	271

**VARILLA ROSCADA MÉTRICA**

Ø d [mm]	Ø d <sub>0</sub> [mm]	h <sub>ef</sub> std [mm]	h <sub>ef</sub> [mm]	T <sub>max</sub> [Nm]
M10	12	90	60...200	20
M12	14	110	70...240	40
M16	18	125	80...320	80
M20	22	170	90...400	150
M24	28	210	96...480	200
M27	30	240	108...540	270
M30	35	270	120...600	300

**INSERTOS ROSCADOS HILTI HIS-N Y HIS-RN**

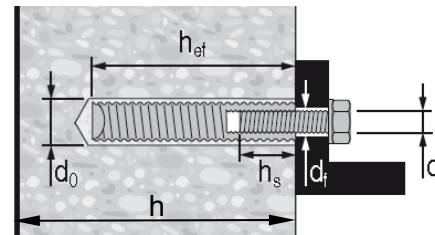

**INSERTOS ROSCADOS HILTI HIS-N Y HIS-RN FRACCIONALES**

Ø d [pulg]	Ø d <sub>0</sub> [pulg]	h <sub>ef</sub> [pulg]	Ø d <sub>i</sub> [pulg]	h <sub>s</sub> [pulg]	T <sub>max</sub> [pie-lb]	T <sub>max</sub> [Nm]
3/8	1 1/16	4 3/8	7/16	3/8...15/16	15	20
1/2	7/8	5	9/16	1/2...1 3/16	30	41
5/8	1 1/8	6 3/4	1 1/16	5/8...1 1/2	60	81
3/4	1 1/4	8 1/8	1 3/16	3/4...1 7/8	100	136

**INSERTOS ROSCADOS HILTI HIS-N Y HIS-RN MÉTRICOS**

Ø d [mm]	Ø d <sub>0</sub> [mm]	h <sub>ef</sub> [mm]	Ø d <sub>i</sub> [mm]	h <sub>s</sub> [mm]	T <sub>max</sub> [Nm]
M8	14	90	9	8...20	10
M10	18	110	12	10...25	20
M12	22	125	14	12...30	40
M16	28	170	18	16...40	80
M20	32	205	22	20...50	150

FIGURA 1—PARÁMETROS DE INSTALACIÓN PARA ANCLAJES ADHESIVOS POST-INSTALADOS (Continuación)



FIGURA 2—PARÁMETROS DE INSTALACIÓN PARA BARRAS DE REFUERZO POST-INSTALADAS



FIGURA 3—EJEMPLOS DE APLICACIONES PARA BARRAS DE REFUERZO POST-INSTALADAS:  
 (A) EMPALME POR TRASLAPO EN TRACCIÓN CON REFUERZO A FLEXIÓN EXISTENTE; (B) DESARROLLO DE TRACCIÓN DE BARRAS POST-INSTALADAS EN COLUMNAS; (C) DE DESARROLLO DE ESPIGOS DE CORTE PARA NUEVOS MUROS DE CORTE SOBREPUESTOS

TABLA 1—ÍNDICE DE LA TABLA DE DISEÑO

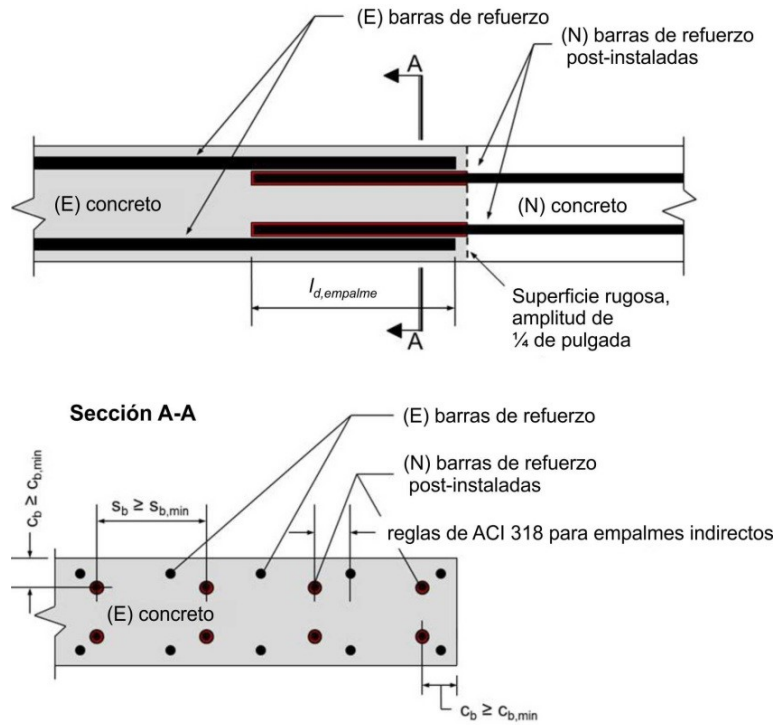

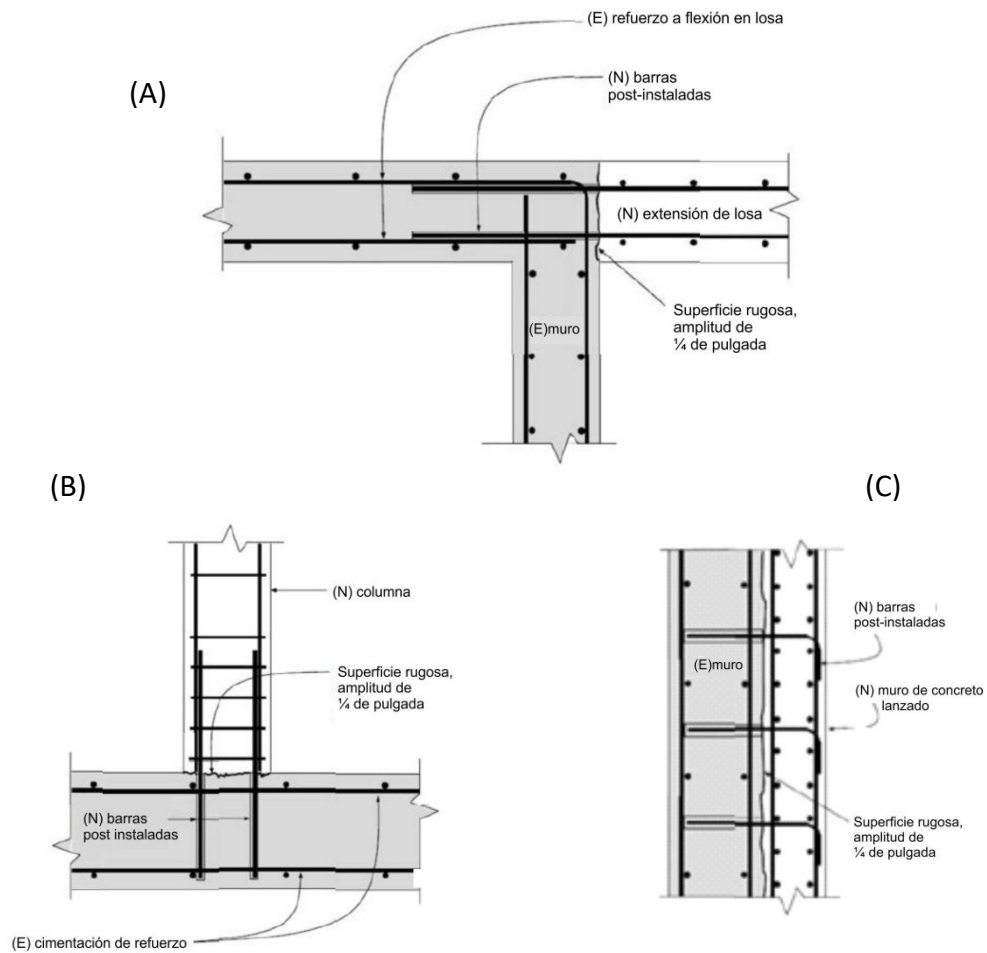

Tabla de diseño		Fraccional		Métrico			
		Tabla	Página	Tabla	Página		
<b>Varilla de Anclaje Hilti HIT-Z e HIT-Z-R</b> 	Resistencia del Acero - $N_{sa}$ , $V_{sa}$	7	15	7	15		
	Arrancamiento del Concreto - $N_{cb}$ , $N_{cbg}$ , $V_{cb}$ , $V_{cbg}$ , $V_{cp}$ , $V_{cpg}$	8	16	8	16		
	Resistencia a la Extracción - $N_p$	10	20	10	20		
<b>Varilla Roscada Estándar</b> 	Resistencia del Acero - $N_{sa}$ , $V_{sa}$	11	21	17	28		
	Arrancamiento del Concreto - $N_{cb}$ , $N_{cbg}$ , $V_{cb}$ , $V_{cbg}$ , $V_{cp}$ , $V_{cpg}$	12	23	18	29		
	Esfuerzo de Adherencia - $N_a$ , $N_{ag}$	15 & 16	26 & 27	21 & 22	32 & 33		
<b>Inserto Hilti HIS-N y HIS-RN de Roscado Interno</b> 	Resistencia del Acero - $N_{sa}$ , $V_{sa}$	27	37	27	37		
	Arrancamiento del Concreto - $N_{cb}$ , $N_{cbg}$ , $V_{cb}$ , $V_{cbg}$ , $V_{cp}$ , $V_{cpg}$	28	38	28	38		
	Esfuerzo de Adherencia - $N_a$ , $N_{ag}$	29	39	29	39		
Tabla de diseño		Fraccional		Métrico de EU		Canadiense	
		Tabla	Página	Tabla	Página	Tabla	Página
<b>Barras de Refuerzo de Acero</b> 	Resistencia del Acero - $N_{sa}$ , $V_{sa}$	11A	22	17	28	23	34
	Arrancamiento del Concreto - $N_{cb}$ , $N_{cbg}$ , $V_{cb}$ , $V_{cbg}$ , $V_{cp}$ , $V_{cpg}$	12	23	18	29	24	34
	Esfuerzo de Adherencia - $N_a$ , $N_{ag}$	13 & 14	24 & 25	19 & 20	30 & 31	25 & 26	35 & 36
	Determinación de la longitud de desarrollo para conexiones de barras de refuerzo post-instaladas	30	40	31	41	32	41

TABLA 2—ESPECIFICACIONES Y PROPIEDADES FÍSICAS DE LAS VARILLAS HIT-Z Y HIT-Z FRACCIONALES Y MÉTRICAS

ESPECIFICACIÓN DE LA VARILLA HIT-Z Y HIT-Z-R			Resistencia última mínima especificada, $f_{uta}$	Resistencia a la fluencia mínima especificada 0.2 por ciento compensado, $f_{ya}$	$f_{uta}/f_{ya}$	Elongación, porcentaje mín.	Reducción de área, porcentaje mín.	Especificación para tuercas <sup>2</sup>	
ACERO AL CARBONO		$\frac{3}{8}$ pulg. a $\frac{5}{8}$ pulg. y M10 a M12 - AISI 1038	psi (MPa)	94,200 (650)	75,300 (520)	1.25	8	20	ASTM A563 Grado A
		$\frac{3}{4}$ pulg. - AISI 1038 o 18MnV5							
		M16 - AISI 1038	psi (MPa)	88,400 (610)	71,000 (490)				
		M20 - AISI 1038 o 18MnV5	psi (MPa)	86,200 (595)	69,600 (480)				
ACERO INOXIDABLE		$\frac{3}{8}$ pulg. a $\frac{3}{4}$ pulg. y M10 a M12	psi (MPa)	94,200 (650)	75,300 (520)	1.25	8	20	ASTM F594 Tipo 316
		Grado 316 DIN-EN 10263-5 X5CrNiMo 17-12-2+AT							
		M16	psi (MPa)	88,400 (610)	71,000 (490)				
		M20	psi (MPa)	86,200 (595)	69,600 (480)				

<sup>1</sup> Las propiedades del acero son valores mínimos y valores máximos que variaran debido a la formación en frío de la varilla.

<sup>2</sup> Los pernos de otros grados y estilos con esfuerzos de carga probada especificados mayor que el grado y estilo especificado. Los pernos deben tener esfuerzos de carga probada especificados igual que o mayor que la resistencia a la tensión mínima de la varilla roscada especificada.

TABLA 3—ESPECIFICACIONES Y PROPIEDADES FÍSICAS DE LOS MATERIALES DE VARILLAS ROSCADAS DE ACERO AL CARBONO COMUNES<sup>1</sup>

ESPECIFICACIÓN DE LA VARILLA ROSCADA			Resistencia última mínima especificada, $f_{uta}$	Resistencia a la fluencia mínima especificada 0.2 por ciento compensado, $f_{ya}$	$f_{uta}/f_{ya}$	Elongación, porcentaje mín. <sup>7</sup>	Reducción de área, porcentaje mín.	Especificación para tuercas <sup>8</sup>	
ACERO AL CARBONO		ASTM A193 <sup>2</sup> Grado B7 $\leq 2\frac{1}{2}$ pulg. ( $\leq 64$ mm)	psi (MPa)	125,000 (862)	105,000 (724)	1.19	16	50	ASTM A563 Grado DH
		ASTM F568M <sup>3</sup> Clase 5.8 M5 ( $\frac{1}{4}$ pulg.) a M24 (1 pulg.) (equivalente a ISO 898-1)	psi (MPa)	72,500 (500)	58,000 (400)	1.25	10	35	ASTM A563 Grado DH <sup>9</sup> DIN 934 (8-A2K)
		ASTM F1554, Grado 36 <sup>7</sup>	psi (MPa)	58,000 (400)	36,000 (248)	1.61	23	40	ASTM A194 o ASTM A563
		ASTM F1554, Grado 55 <sup>7</sup>	psi (MPa)	75,000 (517)	55,000 (379)	1.36	21	30	ASTM A194 o ASTM A563
		ASTM F1554, Grado 105 <sup>7</sup>	psi (MPa)	125,000 (862)	105,000 (724)	1.19	15	45	ASTM A194 o ASTM A563
		ISO 898-1 <sup>4</sup> Clase 5.8	MPa (psi)	500 (72,500)	400 (58,000)	1.25	22	-	DIN 934 Grado 6
		ISO 898-1 <sup>4</sup> Clase 8.8	MPa (psi)	800 (116,000)	640 (92,800)	1.25	12	52	DIN 934 Grado 8
ACERO INOXIDABLE		ASTM F593 <sup>5</sup> CW1 (316) $\frac{1}{4}$ pulg. a $\frac{5}{8}$ pulg.	psi (MPa)	100,000 (689)	65,000 (448)	1.54	20	-	ASTM F594
		ASTM F593 <sup>5</sup> CW2 (316) $\frac{3}{4}$ pulg. a $1\frac{1}{2}$ pulg.	psi (MPa)	85,000 (586)	45,000 (310)	1.89	25	-	ASTM F594
		ASTM A193 Grado 8(M), Clase 1 <sup>2</sup> - $1\frac{1}{4}$ pulg.	psi (MPa)	75,000 (517)	30,000 (207)	2.50	30	50	ASTM F594
		ISO 3506-1 <sup>6</sup> A4-70 M8 - M24	MPa (psi)	700 (101,500)	450 (65,250)	1.56	40	-	ISO 4032
		ISO 3506-1 <sup>6</sup> A4-50 M27 - M30	MPa (psi)	500 (72,500)	210 (30,450)	2.38	40	-	ISO 4032

<sup>1</sup> El adhesivo Hilti HIT-HY 200 V3 puede ser usado junto con todos los grados de varillas de acero al carbono o de acero inoxidable de roscado continuo (de roscado completo) que cumplan con las normas del código de referencia y que tengan características de roscado comparables con las Series de Rosca Gruesa ANSI B1.1 UNC o Series de Perfil de la Rosca Métrica ANSI B1.13M M. Los valores para los tipos de varillas roscadas y tuercas asociadas suministradas por Hilti están provistos aquí.

<sup>2</sup> Especificación Estándar para los Materiales de Tornillos de Acero Inoxidable y Acero Aleado para Servicio de Alta Temperatura

<sup>3</sup> Especificación Estándar para Elementos de Fijación Métricas de Roscado Externo de Acero al Carbono y Acero Aleado

<sup>4</sup> Propiedades mecánicas de elementos de fijación de acero al carbono y acero aleado - Parte 1: Pernos, tornillos y espárragos

<sup>5</sup> Especificación Estándar del Acero para Pernos, Tornillos de Cabeza Hexagonal y Espárragos de Acero Inoxidable

<sup>6</sup> Propiedades Mecánicas de Elementos de Fijación de Acero Inoxidable Resistentes a la Corrosión - Parte 1: Pernos, tornillos y espárragos

<sup>7</sup> Se basa en la longitud inicial de 2 pulg. (50 mm) excepto para A 193, el cual se basa en una longitud inicial de 4d e ISO 898, la cual se basa en 5d.

<sup>8</sup> También son adecuados los pernos de otros grados y estilos con esfuerzos de carga probada especificados mayor que el grado y estilo especificado. Los pernos deben tener esfuerzos de carga probada especificados igual que o mayor que la resistencia a la tensión mínima de la varilla roscada especificada

<sup>9</sup> Pernos para varillas fraccionales.

**TABLA 4—ESPECIFICACIONES Y PROPIEDADES FÍSICAS DE BARRAS DE REFUERZO DE ACERO COMUNES**

ESPECIFICACIÓN DE LA BARRA DE REFUERZO		Resistencia última mínima especificada, $f_{uta}$	Resistencia a la fluencia mínima especificada, $f_{ya}$
			
ASTM A615 <sup>1</sup> Gr. 60	psi (MPa)	80,000 (550)	60,000 (414)
ASTM A615 <sup>1</sup> Gr. 40	psi (MPa)	60,000 (414)	40,000 (276)
ASTM A706 <sup>2</sup> Gr. 60	psi (MPa)	80,000 (550)	60,000 (414)
DIN 488 <sup>3</sup> BSt 500	MPa (psi)	550 (79,750)	500 (72,500)
CAN/CSA-G30.18 <sup>4</sup> Gr. 400	MPa (psi)	540 (78,300)	400 (58,000)

<sup>1</sup> Especificación Estándar para Barras Corrugadas y Barras Rectas de Acero al Carbono para Refuerzo del Concreto

<sup>2</sup> Especificación Estándar para Barras Corrugadas de Acero de Baja Aleación y Barras Rectas para Refuerzo del Concreto

<sup>3</sup> Acero de refuerzo; barras de refuerzo de acero; dimensiones y medidas

<sup>4</sup> Barras de Acero de Lingote para Refuerzo del Concreto

**TABLA 5—ESPECIFICACIONES Y PROPIEDADES FÍSICAS DE INSERTOS HIS-N Y HIS-RN FRACCIONALES Y MÉTRICOS**

INSERTOS HILTI HIS-N Y HIS-RN		Resistencia última mínima especificada, $f_{uta}$	Resistencia a la fluencia mínima especificada, $f_{ya}$
			
Acero al Carbono DIN EN 10277-3 11SMnPb30+c o DIN 1561 9SMnPb28K <sup>3</sup> / <sub>8</sub> pulg. y M8 to M10	psi (MPa)	71,050 (490)	59,450 (410)
Acero al Carbono DIN EN 10277-3 11SMnPb30+c o DIN 1561 9SMnPb28K <sup>1</sup> / <sub>2</sub> to <sup>3</sup> / <sub>4</sub> pulg. y M12 to M20	psi (MPa)	66,700 (460)	54,375 (375)
Acero Inoxidable EN 10088-3 X5CrNiMo 17-12-2	psi (MPa)	101,500 (700)	50,750 (350)

**TABLA 6—ESPECIFICACIONES Y PROPIEDADES FÍSICAS DE PERNOS, TORNILLOS Y ESPÁRRAGOS COMUNES PARA SU USO CON INSERTOS HIS-N Y HIS-RN<sup>1,2</sup>**

ESPECIFICACIÓN DEL PERNO, TORNILLO O ESPÁRRAGO		Resistencia última mínima especificada $f_{uta}$	Resistencia a la fluencia mínima especificada 0.2 por ciento compensado $f_{ya}$	$f_{uta}/f_{ya}$	Elongación, min.	Reducción de área, min.	Especificación para tuercas <sup>6</sup>
							
SAE J429 <sup>3</sup> Grado 5	psi (MPa)	120,000 (828)	92,000 (634)	1.30	14	35	SAE J995
ASTM A325 <sup>4</sup> <sup>1</sup> / <sub>2</sub> a 1 pulg.	psi (MPa)	120,000 (828)	92,000 (634)	1.30	14	35	A563 C, C3, D, DH, DH3 Hexagonal Pesada
ASTM A193 <sup>5</sup> Grado B8M (AISI 316) para uso con HIS-RN	psi (MPa)	110,000 (759)	95,000 (655)	1.16	15	45	ASTM F594 <sup>7</sup> Grupo de Aleación 1, 2 o 3
ASTM A193 <sup>5</sup> Grado B8T (AISI 321) para uso con HIS-RN	psi (MPa)	125,000 (862)	100,000 (690)	1.25	12	35	ASTM F594 <sup>7</sup> Grupo de Aleación 1, 2 o 3

<sup>1</sup> Pernos, tornillos o espárragos Grado 5 mínimo deben usarse con insertos HIS de acero al carbono.

<sup>2</sup> Los pernos, tornillos y espárragos de acero inoxidable deben usarse únicamente con insertos HIS-RN.

<sup>3</sup> Requerimientos Mecánicos y Materiales para Elementos de Fijación de Roscado Externo

<sup>4</sup> Especificación Estándar para Pernos Estructurales, de Acero, Tratado térmicamente, 120/105 ksi Resistencia a la Tensión Mínima

<sup>5</sup> Especificación Estándar para los Materiales de Tornillos de Acero Inoxidable y Acero Aleado para Servicio de Alta Temperatura

<sup>6</sup> Los pernos deben tener esfuerzos de carga probada especificados igual que o mayor que la resistencia a la tensión de tamaño completo mínima especificada del espárrago especificado.

<sup>7</sup> Los pernos para espárragos de acero inoxidable deben ser del mismo grupo de aleación que los pernos, tornillos o espárragos especificados.



Varilla de Anclaje HIT-Z e HIT-Z-R Fraccional y Métrica

Resistencia del Acero

TABLA 7—INFORMACIÓN DEL DISEÑO DEL ACERO PARA VARILLAS DE ANCLAJE HIT-Z Y HIT-Z-R FRACCIONALES Y MÉTRICAS

INFORMACIÓN DE DISEÑO	Símbolo	Unidades	Diámetro Nominal de la Varilla Fraccional (pulg.)				Unidades	Diámetro Nominal de la Varilla Métrico (mm)				
			3/8	1/2	5/8	3/4		10	12	16	20	
Diámetro Exterior de la Varilla	$d$	pulg. (mm)	0.375 (9.5)	0.5 (12.7)	0.625 (15.9)	0.75 (19.1)	mm (pulg.)	10 (0.39)	12 (0.47)	16 (0.63)	20 (0.79)	
Área efectiva de la sección transversal de la varilla	$A_{se}$	pulg. <sup>2</sup> (mm <sup>2</sup> )	0.0775 (50)	0.1419 (92)	0.2260 (146)	0.3340 (216)	mm <sup>2</sup> (pulg. <sup>2</sup> )	58.0 (0.090)	84.3 (0.131)	157.0 (0.243)	245.0 (0.380)	
ACERO AL CARBONO	Resistencia nominal que se rige por la resistencia del acero <sup>1</sup>	$N_{sa}$	lb (kN)	7,306 (32.5)	13,377 (59.5)	21,306 (94.8)	31,472 (140.0)	kN (lb)	37.7 (8,475)	54.8 (12,318)	95.8 (21,529)	145.8 (32,770)
		$V_{sa}$	lb (kN)	3,215 (14.3)	5,886 (26.2)	9,375 (41.7)	13,848 (61.6)	kN (lb)	16.6 (3,729)	24.1 (5,420)	42.2 (9,476)	64.2 (14,421)
	Reducción para el cortante sísmico	$\alpha_{V,seis}$	-	0.65				-	0.65			
	Factor de reducción de resistencia para la tensión <sup>2</sup>	$\phi$	-	0.65				-	0.65			
	Factor de reducción de resistencia para el cortante <sup>2</sup>	$\phi$	-	0.60				-	0.60			
ACERO INOXIDABLE	Resistencia nominal que se rige por la resistencia del acero <sup>1</sup>	$N_{sa}$	lb (kN)	7,306 (32.5)	13,377 (59.5)	21,306 (94.8)	31,472 (140.0)	kN (lb)	37.7 (8,475)	54.8 (12,318)	95.8 (21,529)	145.8 (32,770)
		$V_{sa}$	lb (kN)	4,384 (19.5)	8,026 (35.7)	12,783 (56.9)	18,883 (84.0)	kN (lb)	22.6 (5,085)	32.9 (7,391)	57.5 (12,922)	87.5 (19,666)
	Reducción para el cortante sísmico	$\alpha_{V,seis}$	-	0.79	0.75	0.65		-	0.79	0.75	0.65	
	Factor de reducción de resistencia para la tensión <sup>2</sup>	$\phi$	-	0.65				-	0.65			
	Factor de reducción de resistencia para el cortante <sup>2</sup>	$\phi$	-	0.60				-	0.60			

Para SI: 1 pulgada  $\equiv$  25.4 mm, 1 lbf = 4.448 N, 1 psi = 0.006897 MPa.  
 Para unidades libra-pulgada: 1 mm = 0.03937 pulgadas, 1 N = 0.2248 lbf, 1 MPa = 145.0 psi

<sup>1</sup> Las propiedades del acero son valores mínimos y valores máximos que varían debido a la formación en frío de la varilla.  
<sup>2</sup> Para uso con las cargas combinadas de ACI 318-19 y ACI 318-14 5.3 o ACI 318-11 9.2, como se establece en ACI 318-19 17.5.3, ACI 318-14 17.3.3 o ACI 318-11 D.4.3.

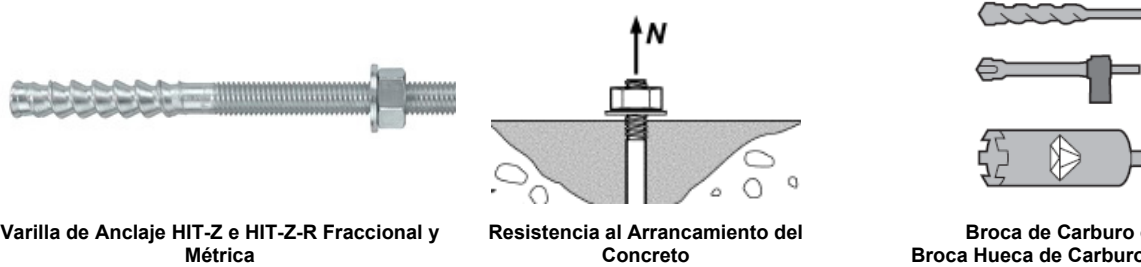

Varilla de Anclaje HIT-Z e HIT-Z-R Fraccional y Métrica

Resistencia al Arrancamiento del Concreto

Broca de Carburo o Broca Hueca de Carburo Hilti o Broca Corona de Diamante

TABLA 8— INFORMACIÓN DE DISEÑO DEL ARRANCAMIENTO DEL CONCRETO PARA VARILLAS DE ANCLAJE HIT-Z Y HIT-Z-R USUALES EN U.S. EN AGUJEROS PERFORADOS CON ROTO MARTILLO Y BROCA DE CARBURO (O BROCA HUECA DE CARBURO HILTI) O PERFORADO CON DIAMANTE<sup>1</sup>

INFORMACIÓN DE DISEÑO	Símbolo	Unidades	Diámetro Nominal de la Varilla Fraccional (pulg.)				Unidades	Diámetro Nominal de la Varilla Métrica (mm)			
			3/8	1/2	5/8	3/4		10	12	16	20
Factor de efectividad para concreto fisurado	$k_{c,cr}$	pulg-lb (SI)	17 (7.1)				SI (pulg-lb)	7.1 (17)			
Factor de efectividad para concreto no fisurado	$k_{c,uncr}$	pulg-lb (SI)	24 (10)				SI (pulg-lb)	10 (24)			
Profundidad de empotramiento mínima <sup>3</sup>	$h_{ef,min}$	pulg. (mm)	2 <sup>3</sup> / <sub>8</sub> (60)	2 <sup>3</sup> / <sub>4</sub> (70)	3 <sup>3</sup> / <sub>4</sub> (95)	4 (102)	mm (pulg.)	60 (2.4)	70 (2.8)	96 (3.8)	100 (3.9)
Profundidad de empotramiento máxima <sup>3</sup>	$h_{ef,max}$	pulg. (mm)	4 <sup>1</sup> / <sub>2</sub> (114)	6 (152)	7 <sup>1</sup> / <sub>2</sub> (190)	8 <sup>1</sup> / <sub>2</sub> (216)	mm (pulg.)	120 (4.7)	144 (5.7)	192 (7.6)	220 (8.7)
Separación mínima entre anclajes	$s_{min}$	-	Ver Sección 4.1.9.1 de este reporte. Combinaciones pre-calculadas de la separación entre anclajes y la distancia al borde están provistas en la Tabla 9 de este reporte.				-	Ver Sección 4.1.9.1 de este reporte. Combinaciones pre-calculadas de la separación entre anclajes y la distancia al borde están provistas en la Tabla 9 de este reporte.			
Distancia mínima al borde	$c_{min}$	-	Ver Sección 4.1.9.1 de este reporte. Combinaciones pre-calculadas de la separación entre anclajes y la distancia al borde están provistas en la Tabla 9 de este reporte.				-	Ver Sección 4.1.9.1 de este reporte. Combinaciones pre-calculadas de la separación entre anclajes y la distancia al borde están provistas en la Tabla 9 de este reporte.			
Espesor mínimo del concreto Condición del agujero 1 <sup>3</sup>	$h_{min,1}$	pulg. (mm)	$h_{ef} + 2\frac{1}{4}$ ( $h_{ef} + 57$ )		$h_{ef} + 4$ ( $h_{ef} + 102$ )		mm (pulg.)	$h_{ef} + 60$ ( $h_{ef} + 2.4$ )		$h_{ef} + 100$ ( $h_{ef} + 3.9$ )	
Espesor mínimo del concreto Condición del agujero 2 <sup>3</sup>	$h_{min,2}$	pulg. (mm)	$h_{ef} + 1\frac{1}{4} \geq 4$ ( $h_{ef} + 32 \geq 100$ )		$h_{ef} + 1\frac{3}{4}$ ( $h_{ef} + 45$ )		mm (pulg.)	$h_{ef} + 30 \geq 100$ ( $h_{ef} + 1.25 \geq 3.9$ )		$h_{ef} + 45$ ( $h_{ef} + 1.8$ )	
Distancia crítica al borde – hendimiento (para concreto no fisurado)	$c_{ac}$	-	Ver Sección 4.1.10.1 de este reporte				-	Ver Sección 4.1.10.1 de este reporte			
Factor de reducción de resistencia para la tensión, modos de falla del concreto, Condición B (sin reforzamiento suplementario) <sup>2</sup>	$\phi$	-	0.65				-	0.65			
Factor de reducción de resistencia para el cortante, modos de falla del concreto, Condición B (sin reforzamiento suplementario) <sup>2</sup>	$\phi$	-	0.70				-	0.70			

Para SI: 1 pulgada  $\approx$  25.4 mm, 1 lbf = 4.448 N, 1 psi = 0.006897 MPa.  
 Para unidades libra-pulgada: 1 mm = 0.03937 pulgadas, 1 N = 0.2248 lbf, 1 MPa = 145.0 psi

<sup>1</sup> Información de ajuste adicional se describe en la Figura 6, Instrucciones de instalación impresas del fabricante (MPII)  
<sup>2</sup> El factor de reducción de resistencia se aplica cuando se usan las cargas combinadas del IBC o ACI 318 y se cumplen los requisitos de ACI 318-19 17.5.3, ACI 318-14 17.3.3 o ACI 318-11 D.4.3, según aplique. Si se usan las cargas combinadas del Apéndice C de ACI 318-11, el valor apropiado del factor de reducción de resistencia debe determinarse de acuerdo con ACI 318-11 D.4.4.  
<sup>3</sup> La condición de la perforación se describe abajo en la Figura 4.



FIGURA 4—DEFINICIÓN DE LAS CONDICIONES DE LA PERFORACIÓN PARA VARILLAS DE ANCLAJE HILTI HIT-Z Y HIT-Z-R



**TABLA 9—COMBINACIONES PRE-CALCULADAS DE DISTANCIA AL BORDE Y SEPARACIÓN PARA VARILLAS HILTI HIT-Z Y HIT-Z-R**

INFORMACIÓN DE DISEÑO			Símbolo	Unidades	Diámetro Nominal de la Varilla (pulg.) – Fraccional								
Diámetro Exterior de la Varilla			<i>d</i>	pulg. (mm)	<sup>3</sup> / <sub>8</sub> (9.5)								
Empotramiento efectivo			<i>h<sub>ef</sub></i>	pulg. (mm)	2 <sup>3</sup> / <sub>8</sub> (60)			3 <sup>3</sup> / <sub>8</sub> (86)		4 <sup>1</sup> / <sub>2</sub> (114)			
Condición del agujero perforado <sup>1</sup>			-	-	2	1 o 2		2	1 o 2		2	1 o 2	
Espesor mínimo del concreto			<i>h</i>	pulg. (mm)	4 (102)	4 <sup>5</sup> / <sub>8</sub> (117)	5 <sup>3</sup> / <sub>4</sub> (146)	4 <sup>5</sup> / <sub>8</sub> (117)	5 <sup>3</sup> / <sub>8</sub> (143)	6 <sup>3</sup> / <sub>8</sub> (162)	5 <sup>3</sup> / <sub>4</sub> (146)	6 <sup>3</sup> / <sub>4</sub> (171)	7 <sup>3</sup> / <sub>8</sub> (187)
CONCRETO NO FISURADO	Borde y separación mínimos Caso 1 <sup>2</sup>	<i>c<sub>min,1</sub></i>	pulg. (mm)	3 <sup>1</sup> / <sub>8</sub> (79)	2 <sup>3</sup> / <sub>4</sub> (70)	2 <sup>1</sup> / <sub>4</sub> (57)	2 <sup>3</sup> / <sub>4</sub> (70)	2 <sup>1</sup> / <sub>4</sub> (57)	2 (51)	2 <sup>1</sup> / <sub>4</sub> (57)	1 <sup>7</sup> / <sub>8</sub> (48)	1 <sup>7</sup> / <sub>8</sub> (48)	
		<i>s<sub>min,1</sub></i>	pulg. (mm)	9 <sup>1</sup> / <sub>8</sub> (232)	7 <sup>3</sup> / <sub>4</sub> (197)	6 <sup>1</sup> / <sub>8</sub> (156)	7 <sup>3</sup> / <sub>4</sub> (197)	6 <sup>1</sup> / <sub>2</sub> (165)	5 <sup>5</sup> / <sub>8</sub> (143)	6 <sup>1</sup> / <sub>8</sub> (156)	5 <sup>5</sup> / <sub>8</sub> (137)	4 <sup>1</sup> / <sub>2</sub> (114)	4 <sup>1</sup> / <sub>2</sub> (114)
	Borde y separación mínimos Caso 2 <sup>2</sup>	<i>c<sub>min,2</sub></i>	pulg. (mm)	5 <sup>5</sup> / <sub>8</sub> (143)	4 <sup>3</sup> / <sub>4</sub> (121)	3 <sup>3</sup> / <sub>4</sub> (95)	4 <sup>3</sup> / <sub>4</sub> (121)	3 <sup>7</sup> / <sub>8</sub> (98)	3 <sup>1</sup> / <sub>4</sub> (83)	3 <sup>3</sup> / <sub>4</sub> (95)	3 <sup>1</sup> / <sub>8</sub> (79)	2 <sup>3</sup> / <sub>4</sub> (70)	2 <sup>3</sup> / <sub>4</sub> (70)
		<i>s<sub>min,2</sub></i>	pulg. (mm)	1 <sup>7</sup> / <sub>8</sub> (48)	1 <sup>7</sup> / <sub>8</sub> (48)	1 <sup>7</sup> / <sub>8</sub> (48)	1 <sup>7</sup> / <sub>8</sub> (48)	1 <sup>7</sup> / <sub>8</sub> (48)	1 <sup>7</sup> / <sub>8</sub> (48)	1 <sup>7</sup> / <sub>8</sub> (48)	1 <sup>7</sup> / <sub>8</sub> (48)	1 <sup>7</sup> / <sub>8</sub> (48)	1 <sup>7</sup> / <sub>8</sub> (48)
CONCRETO FISURADO	Borde y separación mínimos Caso 1 <sup>2</sup>	<i>c<sub>min,1</sub></i>	pulg. (mm)	2 <sup>1</sup> / <sub>8</sub> (54)	1 <sup>7</sup> / <sub>8</sub> (48)	1 <sup>7</sup> / <sub>8</sub> (48)	1 <sup>7</sup> / <sub>8</sub> (48)	1 <sup>7</sup> / <sub>8</sub> (48)	1 <sup>7</sup> / <sub>8</sub> (48)	1 <sup>7</sup> / <sub>8</sub> (48)	1 <sup>7</sup> / <sub>8</sub> (48)	1 <sup>7</sup> / <sub>8</sub> (48)	
		<i>s<sub>min,1</sub></i>	pulg. (mm)	6 <sup>3</sup> / <sub>8</sub> (162)	5 <sup>1</sup> / <sub>2</sub> (140)	4 <sup>1</sup> / <sub>4</sub> (108)	5 <sup>1</sup> / <sub>2</sub> (140)	3 <sup>1</sup> / <sub>2</sub> (89)	2 <sup>5</sup> / <sub>8</sub> (67)	3 <sup>1</sup> / <sub>4</sub> (83)	2 (51)	1 <sup>7</sup> / <sub>8</sub> (48)	1 <sup>7</sup> / <sub>8</sub> (48)
	Borde y separación mínimos Caso 2 <sup>2</sup>	<i>c<sub>min,2</sub></i>	pulg. (mm)	3 <sup>5</sup> / <sub>8</sub> (92)	3 <sup>1</sup> / <sub>8</sub> (79)	2 <sup>5</sup> / <sub>8</sub> (60)	3 <sup>1</sup> / <sub>8</sub> (79)	2 <sup>1</sup> / <sub>2</sub> (64)	2 <sup>1</sup> / <sub>8</sub> (54)	2 <sup>3</sup> / <sub>8</sub> (60)	2 (51)	1 <sup>7</sup> / <sub>8</sub> (48)	1 <sup>7</sup> / <sub>8</sub> (48)
		<i>s<sub>min,2</sub></i>	pulg. (mm)	1 <sup>7</sup> / <sub>8</sub> (48)	1 <sup>7</sup> / <sub>8</sub> (48)	1 <sup>7</sup> / <sub>8</sub> (48)	1 <sup>7</sup> / <sub>8</sub> (48)	1 <sup>7</sup> / <sub>8</sub> (48)	1 <sup>7</sup> / <sub>8</sub> (48)	1 <sup>7</sup> / <sub>8</sub> (48)	1 <sup>7</sup> / <sub>8</sub> (48)	1 <sup>7</sup> / <sub>8</sub> (48)	1 <sup>7</sup> / <sub>8</sub> (48)

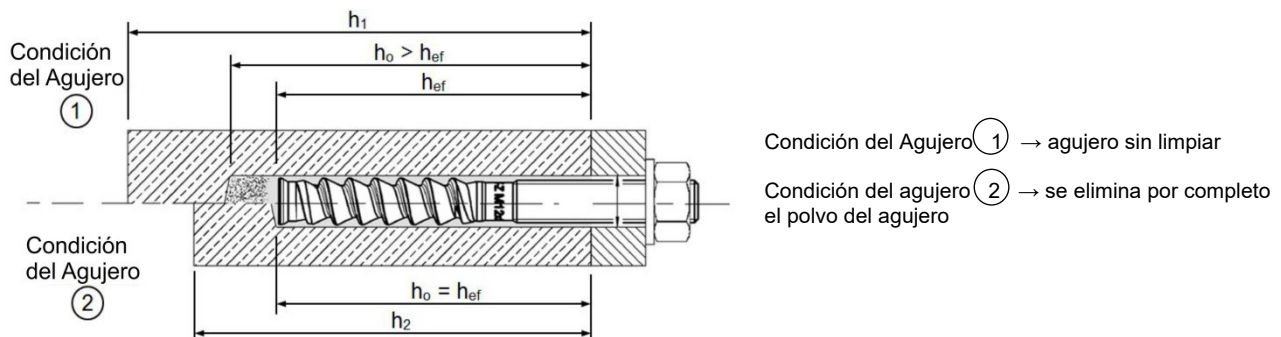
INFORMACIÓN DE DISEÑO			Símbolo	Unidades	Diámetro Nominal de la Varilla (pulg.) – Fraccional								
Diámetro Exterior de la Varilla			<i>d</i>	pulg. (mm)	<sup>1</sup> / <sub>2</sub> (12.7)								
Empotramiento efectivo			<i>h<sub>ef</sub></i>	pulg. (mm)	2- <sup>3</sup> / <sub>4</sub> (70)			4 <sup>1</sup> / <sub>2</sub> (114)		6 (152)			
Condición del agujero perforado <sup>1</sup>			-	-	2	1 o 2		2	1 o 2		2	1 o 2	
Espesor mínimo del concreto			<i>h</i>	pulg. (mm)	4 (102)	5 (127)	7 <sup>1</sup> / <sub>8</sub> (181)	5 <sup>3</sup> / <sub>4</sub> (146)	6 <sup>3</sup> / <sub>4</sub> (171)	8 <sup>1</sup> / <sub>4</sub> (210)	7 <sup>1</sup> / <sub>4</sub> (184)	8 <sup>1</sup> / <sub>4</sub> (210)	9 <sup>3</sup> / <sub>4</sub> (248)
CONCRETO NO FISURADO	Borde y separación mínimos Caso 1 <sup>2</sup>	<i>c<sub>min,1</sub></i>	pulg. (mm)	5 <sup>1</sup> / <sub>8</sub> (130)	4 <sup>1</sup> / <sub>8</sub> (105)	2 <sup>7</sup> / <sub>8</sub> (73)	3 <sup>5</sup> / <sub>8</sub> (92)	3 (76)	2 <sup>1</sup> / <sub>2</sub> (64)	2 <sup>1</sup> / <sub>8</sub> (73)	2 <sup>1</sup> / <sub>2</sub> (64)	2 <sup>1</sup> / <sub>2</sub> (64)	
		<i>s<sub>min,1</sub></i>	pulg. (mm)	14 <sup>7</sup> / <sub>8</sub> (378)	11 <sup>7</sup> / <sub>8</sub> (302)	8 <sup>5</sup> / <sub>8</sub> (219)	10 <sup>1</sup> / <sub>4</sub> (260)	9 (229)	7 <sup>1</sup> / <sub>4</sub> (184)	8 <sup>1</sup> / <sub>8</sub> (206)	7 <sup>1</sup> / <sub>4</sub> (184)	5 (127)	
	Borde y separación mínimos Caso 2 <sup>2</sup>	<i>c<sub>min,2</sub></i>	pulg. (mm)	9 <sup>1</sup> / <sub>4</sub> (235)	7 <sup>1</sup> / <sub>4</sub> (184)	4 <sup>7</sup> / <sub>8</sub> (124)	6 <sup>1</sup> / <sub>4</sub> (159)	5 <sup>1</sup> / <sub>4</sub> (133)	4 <sup>7</sup> / <sub>8</sub> (105)	4 <sup>3</sup> / <sub>8</sub> (121)	4 <sup>1</sup> / <sub>8</sub> (105)	3 <sup>5</sup> / <sub>8</sub> (86)	
		<i>s<sub>min,2</sub></i>	pulg. (mm)	2 <sup>1</sup> / <sub>2</sub> (64)	2 <sup>1</sup> / <sub>2</sub> (64)	2 <sup>1</sup> / <sub>2</sub> (64)	2 <sup>1</sup> / <sub>2</sub> (64)	2 <sup>1</sup> / <sub>2</sub> (64)	2 <sup>1</sup> / <sub>2</sub> (64)	2 <sup>1</sup> / <sub>2</sub> (64)	2 <sup>1</sup> / <sub>2</sub> (64)	2 <sup>1</sup> / <sub>2</sub> (64)	
CONCRETO FISURADO	Borde y separación mínimos Caso 1 <sup>2</sup>	<i>c<sub>min,1</sub></i>	pulg. (mm)	3 <sup>5</sup> / <sub>8</sub> (92)	3 (76)	2 <sup>1</sup> / <sub>2</sub> (64)	2 <sup>5</sup> / <sub>8</sub> (67)	2 <sup>1</sup> / <sub>2</sub> (64)	2 <sup>1</sup> / <sub>2</sub> (64)	2 <sup>1</sup> / <sub>2</sub> (64)	2 <sup>1</sup> / <sub>2</sub> (64)	2 <sup>1</sup> / <sub>2</sub> (64)	
		<i>s<sub>min,1</sub></i>	pulg. (mm)	10 <sup>7</sup> / <sub>8</sub> (276)	8 <sup>1</sup> / <sub>2</sub> (216)	6 (152)	7 <sup>3</sup> / <sub>8</sub> (187)	5 <sup>1</sup> / <sub>2</sub> (140)	3 <sup>1</sup> / <sub>8</sub> (79)	4 <sup>1</sup> / <sub>2</sub> (114)	3 <sup>1</sup> / <sub>8</sub> (79)	2 <sup>1</sup> / <sub>2</sub> (64)	
	Borde y separación mínimos Caso 2 <sup>2</sup>	<i>c<sub>min,2</sub></i>	pulg. (mm)	6 <sup>1</sup> / <sub>2</sub> (165)	5 (127)	3 <sup>1</sup> / <sub>4</sub> (83)	4 <sup>1</sup> / <sub>4</sub> (108)	3 <sup>1</sup> / <sub>2</sub> (89)	2 <sup>3</sup> / <sub>4</sub> (70)	3 <sup>1</sup> / <sub>4</sub> (83)	2 <sup>3</sup> / <sub>4</sub> (70)	2 <sup>1</sup> / <sub>2</sub> (64)	
		<i>s<sub>min,2</sub></i>	pulg. (mm)	2 <sup>1</sup> / <sub>2</sub> (64)	2 <sup>1</sup> / <sub>2</sub> (64)	2 <sup>1</sup> / <sub>2</sub> (64)	2 <sup>1</sup> / <sub>2</sub> (64)	2 <sup>1</sup> / <sub>2</sub> (64)	2 <sup>1</sup> / <sub>2</sub> (64)	2 <sup>1</sup> / <sub>2</sub> (64)	2 <sup>1</sup> / <sub>2</sub> (64)	2 <sup>1</sup> / <sub>2</sub> (64)	

INFORMACIÓN DE DISEÑO			Símbolo	Unidades	Diámetro Nominal de la Varilla (pulg.) – Fraccional								
Diámetro Exterior de la Varilla			<i>d</i>	pulg. (mm)	<sup>5</sup> / <sub>8</sub> (15.9)								
Empotramiento efectivo			<i>h<sub>ef</sub></i>	pulg. (mm)	3 <sup>3</sup> / <sub>4</sub> (95)			5 <sup>5</sup> / <sub>8</sub> (143)		7 <sup>1</sup> / <sub>2</sub> (191)			
Condición del agujero perforado <sup>1</sup>			-	-	2	1 o 2		2	1 o 2		2	1 o 2	
Espesor mínimo del concreto			<i>h</i>	pulg. (mm)	5 <sup>1</sup> / <sub>2</sub> (140)	7 <sup>3</sup> / <sub>4</sub> (197)	9 <sup>3</sup> / <sub>8</sub> (238)	7 <sup>3</sup> / <sub>8</sub> (187)	9 <sup>5</sup> / <sub>8</sub> (244)	10 <sup>1</sup> / <sub>2</sub> (267)	9 <sup>1</sup> / <sub>4</sub> (235)	11 <sup>1</sup> / <sub>2</sub> (292)	12 <sup>1</sup> / <sub>4</sub> (311)
CONCRETO NO FISURADO	Borde y separación mínimos Caso 1 <sup>2</sup>	<i>c<sub>min,1</sub></i>	pulg. (mm)	6 <sup>1</sup> / <sub>4</sub> (159)	4 <sup>1</sup> / <sub>2</sub> (114)	3 <sup>3</sup> / <sub>4</sub> (95)	4 <sup>5</sup> / <sub>8</sub> (117)	3 <sup>5</sup> / <sub>8</sub> (92)	3 <sup>1</sup> / <sub>4</sub> (83)	3 <sup>3</sup> / <sub>4</sub> (95)	3 <sup>1</sup> / <sub>8</sub> (79)	3 <sup>1</sup> / <sub>8</sub> (79)	
		<i>s<sub>min,1</sub></i>	pulg. (mm)	18 <sup>3</sup> / <sub>8</sub> (467)	12 <sup>7</sup> / <sub>8</sub> (327)	10 <sup>5</sup> / <sub>8</sub> (270)	13 <sup>7</sup> / <sub>8</sub> (352)	10 <sup>3</sup> / <sub>8</sub> (264)	9 <sup>3</sup> / <sub>4</sub> (248)	10 <sup>7</sup> / <sub>8</sub> (276)	8 <sup>3</sup> / <sub>8</sub> (213)	7 <sup>3</sup> / <sub>8</sub> (187)	
	Borde y separación mínimos Caso 2 <sup>2</sup>	<i>c<sub>min,2</sub></i>	pulg. (mm)	11 <sup>3</sup> / <sub>8</sub> (289)	7 <sup>3</sup> / <sub>4</sub> (197)	6 <sup>1</sup> / <sub>4</sub> (159)	8 <sup>1</sup> / <sub>4</sub> (210)	6 <sup>1</sup> / <sub>8</sub> (156)	5 <sup>1</sup> / <sub>2</sub> (140)	6 <sup>3</sup> / <sub>8</sub> (162)	4 <sup>7</sup> / <sub>8</sub> (124)	4 <sup>5</sup> / <sub>8</sub> (117)	
		<i>s<sub>min,2</sub></i>	pulg. (mm)	3 <sup>1</sup> / <sub>8</sub> (79)	3 <sup>1</sup> / <sub>8</sub> (79)	3 <sup>1</sup> / <sub>8</sub> (79)	3 <sup>1</sup> / <sub>8</sub> (79)	3 <sup>1</sup> / <sub>8</sub> (79)	3 <sup>1</sup> / <sub>8</sub> (79)	3 <sup>1</sup> / <sub>8</sub> (79)	3 <sup>1</sup> / <sub>8</sub> (79)	3 <sup>1</sup> / <sub>8</sub> (79)	
CONCRETO FISURADO	Borde y separación mínimos Caso 1 <sup>2</sup>	<i>c<sub>min,1</sub></i>	pulg. (mm)	4 <sup>5</sup> / <sub>8</sub> (117)	3 <sup>3</sup> / <sub>8</sub> (86)	3 <sup>1</sup> / <sub>8</sub> (79)	3 <sup>1</sup> / <sub>2</sub> (89)	3 <sup>1</sup> / <sub>8</sub> (79)	3 <sup>1</sup> / <sub>8</sub> (79)	3 <sup>1</sup> / <sub>8</sub> (79)	3 <sup>1</sup> / <sub>8</sub> (79)	3 <sup>1</sup> / <sub>8</sub> (79)	
		<i>s<sub>min,1</sub></i>	pulg. (mm)	13 <sup>1</sup> / <sub>8</sub> (352)	9 <sup>1</sup> / <sub>2</sub> (241)	8 <sup>1</sup> / <sub>4</sub> (222)	10 <sup>1</sup> / <sub>8</sub> (257)	6 <sup>1</sup> / <sub>2</sub> (165)	5 <sup>5</sup> / <sub>8</sub> (137)	7 <sup>1</sup> / <sub>8</sub> (181)	3 <sup>7</sup> / <sub>8</sub> (98)	3 <sup>1</sup> / <sub>8</sub> (79)	
	Borde y separación mínimos Caso 2 <sup>2</sup>	<i>c<sub>min,2</sub></i>	pulg. (mm)	8 <sup>1</sup> / <sub>4</sub> (210)	5 <sup>1</sup> / <sub>2</sub> (140)	4 <sup>5</sup> / <sub>8</sub> (111)	5 <sup>7</sup> / <sub>8</sub> (149)	4 <sup>1</sup> / <sub>4</sub> (108)	3 <sup>1</sup> / <sub>8</sub> (98)	4 <sup>1</sup> / <sub>2</sub> (114)	3 <sup>5</sup> / <sub>8</sub> (86)	3 <sup>1</sup> / <sub>8</sub> (79)	
		<i>s<sub>min,2</sub></i>	pulg. (mm)	3 <sup>1</sup> / <sub>8</sub> (79)	3 <sup>1</sup> / <sub>8</sub> (79)	3 <sup>1</sup> / <sub>8</sub> (79)	3 <sup>1</sup> / <sub>8</sub> (79)	3 <sup>1</sup> / <sub>8</sub> (79)	3 <sup>1</sup> / <sub>8</sub> (79)	3 <sup>1</sup> / <sub>8</sub> (79)	3 <sup>1</sup> / <sub>8</sub> (79)	3 <sup>1</sup> / <sub>8</sub> (79)	

Para SI: 1 pulgada ≅ 25.4 mm

<sup>1</sup> Ver Figura 4 para la descripción de la condición del agujero perforado.

<sup>2</sup> Se permite la interpolación lineal para establecer las combinaciones de la distancia al borde y separación entre el caso 1 y caso 2.

Interpolación lineal para una distancia *l* para una distancia *c*, donde *c<sub>min,1</sub>* < *c* < *c<sub>min,2</sub>*, determinará el espaciado permisible, *s*, de la siguiente manera:

$$s \geq s_{min,2} + \frac{(s_{min,1} - s_{min,2})}{(c_{min,1} - c_{min,2})} (c - c_{min,2})$$

**TABLA 9— COMBINACIONES PRE-CALCULADAS DE DISTANCIA AL BORDE Y SEPARACIÓN PARA VARILLAS HILTI HIT-Z Y HIT-Z-R (Continuación)**

INFORMACIÓN DE DISEÑO			Símbolo	Unidades	Diámetro Nominal de la Varilla (pulg.) – Fraccional								
Diámetro Exterior de la Varilla			<i>d</i>	pulg. (mm)	<sup>3</sup> / <sub>4</sub> (19.1)								
Empotramiento efectivo			<i>h<sub>ef</sub></i>	pulg. (mm)	4 (102)			6 <sup>3</sup> / <sub>4</sub> (171)		8 <sup>1</sup> / <sub>2</sub> (216)			
Condición del agujero perforado <sup>1</sup>			-	-	2	1 o 2		2	1 o 2		2	1 o 2	
Espesor mínimo del concreto			<i>h</i>	pulg. (mm)	5 <sup>3</sup> / <sub>4</sub> (146)	8 (203)	11 <sup>1</sup> / <sub>2</sub> (292)	8 <sup>1</sup> / <sub>2</sub> (216)	10 <sup>3</sup> / <sub>4</sub> (273)	13 <sup>1</sup> / <sub>8</sub> (333)	10 <sup>1</sup> / <sub>4</sub> (260)	12 <sup>1</sup> / <sub>2</sub> (318)	14 <sup>1</sup> / <sub>2</sub> (368)
CONCRETO NO FISURADO	Borde y separación mínimos Caso 1 <sup>2</sup>	<i>C<sub>min,1</sub></i>	pulg. (mm)	9 <sup>3</sup> / <sub>4</sub> (248)	7 (178)	5 (127)	6 <sup>5</sup> / <sub>8</sub> (168)	5 <sup>1</sup> / <sub>4</sub> (133)	4 <sup>1</sup> / <sub>4</sub> (108)	5 <sup>1</sup> / <sub>2</sub> (140)	4 <sup>1</sup> / <sub>2</sub> (114)	4 (102)	
		<i>S<sub>min,1</sub></i>	pulg. (mm)	28 <sup>3</sup> / <sub>4</sub> (730)	20 <sup>5</sup> / <sub>8</sub> (524)	14 (356)	19 <sup>3</sup> / <sub>8</sub> (492)	15 <sup>1</sup> / <sub>4</sub> (387)	12 <sup>5</sup> / <sub>8</sub> (321)	16 (406)	13 <sup>1</sup> / <sub>4</sub> (337)	11 (279)	
	Borde y separación mínimos Caso 2 <sup>2</sup>	<i>C<sub>min,2</sub></i>	pulg. (mm)	18 <sup>1</sup> / <sub>8</sub> (460)	12 <sup>5</sup> / <sub>8</sub> (321)	8 <sup>1</sup> / <sub>2</sub> (216)	11 <sup>1</sup> / <sub>8</sub> (302)	9 <sup>1</sup> / <sub>8</sub> (232)	7 <sup>1</sup> / <sub>4</sub> (184)	9 <sup>5</sup> / <sub>8</sub> (244)	7 <sup>3</sup> / <sub>4</sub> (197)	6 <sup>1</sup> / <sub>2</sub> (165)	
		<i>S<sub>min,2</sub></i>	pulg. (mm)	3 <sup>3</sup> / <sub>4</sub> (95)	3 <sup>3</sup> / <sub>4</sub> (95)	3 <sup>3</sup> / <sub>4</sub> (95)	3 <sup>3</sup> / <sub>4</sub> (95)	3 <sup>3</sup> / <sub>4</sub> (95)	3 <sup>3</sup> / <sub>4</sub> (95)	3 <sup>3</sup> / <sub>4</sub> (95)	3 <sup>3</sup> / <sub>4</sub> (95)	3 <sup>3</sup> / <sub>4</sub> (95)	
CONCRETO FISURADO	Borde y separación mínimos Caso 1 <sup>2</sup>	<i>C<sub>min,1</sub></i>	pulg. (mm)	7 <sup>1</sup> / <sub>4</sub> (184)	5 <sup>1</sup> / <sub>4</sub> (133)	4 <sup>1</sup> / <sub>8</sub> (105)	5 (127)	4 (102)	3 <sup>3</sup> / <sub>4</sub> (95)	4 <sup>1</sup> / <sub>8</sub> (105)	3 <sup>3</sup> / <sub>4</sub> (95)	3 <sup>3</sup> / <sub>4</sub> (95)	
		<i>S<sub>min,1</sub></i>	pulg. (mm)	21 <sup>3</sup> / <sub>4</sub> (552)	15 <sup>1</sup> / <sub>2</sub> (394)	12 <sup>1</sup> / <sub>4</sub> (311)	14 <sup>1</sup> / <sub>2</sub> (368)	11 <sup>3</sup> / <sub>8</sub> (289)	9 (229)	12 <sup>1</sup> / <sub>8</sub> (308)	8 <sup>3</sup> / <sub>4</sub> (222)	6 <sup>1</sup> / <sub>2</sub> (165)	
	Borde y separación mínimos Caso 2 <sup>2</sup>	<i>C<sub>min,2</sub></i>	pulg. (mm)	13 <sup>1</sup> / <sub>4</sub> (337)	9 <sup>1</sup> / <sub>4</sub> (235)	6 (152)	8 <sup>5</sup> / <sub>8</sub> (219)	6 <sup>5</sup> / <sub>8</sub> (168)	5 <sup>1</sup> / <sub>8</sub> (130)	7 (178)	5 <sup>1</sup> / <sub>2</sub> (140)	4 <sup>1</sup> / <sub>2</sub> (114)	
		<i>S<sub>min,2</sub></i>	pulg. (mm)	3 <sup>3</sup> / <sub>4</sub> (95)	3 <sup>3</sup> / <sub>4</sub> (95)	3 <sup>3</sup> / <sub>4</sub> (95)	3 <sup>3</sup> / <sub>4</sub> (95)	3 <sup>3</sup> / <sub>4</sub> (95)	3 <sup>3</sup> / <sub>4</sub> (95)	3 <sup>3</sup> / <sub>4</sub> (95)	3 <sup>3</sup> / <sub>4</sub> (95)	3 <sup>3</sup> / <sub>4</sub> (95)	

INFORMACIÓN DE DISEÑO			Símbolo	Unidades	Diámetro Nominal de la Varilla (mm) – Métrico								
Diámetro Exterior de la Varilla			<i>d</i>	mm (pulg.)	10 (0.39)								
Empotramiento efectivo			<i>h<sub>ef</sub></i>	mm (pulg.)	60 (2.36)			90 (3.54)		120 (4.72)			
Condición del agujero perforado <sup>1</sup>			-	-	2	1 o 2		2	1 o 2		2	1 o 2	
Espesor mínimo del concreto			<i>h</i>	mm (pulg.)	100 (3.94)	120 (4.72)	156 (6.14)	120 (4.72)	150 (5.91)	176 (6.91)	150 (5.91)	180 (7.09)	197 (7.74)
CONCRETO NO FISURADO	Borde y separación mínimos Caso 1 <sup>2</sup>	<i>C<sub>min,1</sub></i>	mm (pulg.)	99 (3.90)	83 (3.27)	64 (2.52)	83 (3.27)	66 (2.60)	57 (2.24)	66 (2.60)	55 (2.17)	51 (2.01)	
		<i>S<sub>min,1</sub></i>	mm (pulg.)	295 (11.61)	244 (9.61)	187 (7.36)	244 (9.61)	197 (7.76)	166 (6.54)	197 (7.76)	164 (6.46)	148 (5.83)	
	Borde y separación mínimos Caso 2 <sup>2</sup>	<i>C<sub>min,2</sub></i>	mm (pulg.)	181 (7.13)	148 (5.83)	110 (4.33)	148 (5.83)	115 (4.53)	96 (3.78)	115 (4.53)	93 (3.66)	84 (3.31)	
		<i>S<sub>min,2</sub></i>	mm (pulg.)	50 (1.97)	50 (1.97)	50 (1.97)	50 (1.97)	50 (1.97)	50 (1.97)	50 (1.97)	50 (1.97)	50 (1.97)	
CONCRETO FISURADO	Borde y separación mínimos Caso 1 <sup>2</sup>	<i>C<sub>min,1</sub></i>	mm (pulg.)	71 (2.80)	59 (2.32)	52 (2.05)	59 (2.32)	50 (1.97)	50 (1.97)	50 (1.97)	50 (1.97)	50 (1.97)	
		<i>S<sub>min,1</sub></i>	mm (pulg.)	209 (8.23)	174 (6.85)	150 (5.91)	174 (6.85)	131 (5.16)	106 (4.17)	131 (5.16)	84 (3.31)	66 (2.60)	
	Borde y separación mínimos Caso 2 <sup>2</sup>	<i>C<sub>min,2</sub></i>	mm (pulg.)	124 (4.88)	101 (3.98)	74 (2.91)	101 (3.98)	77 (3.03)	64 (2.52)	77 (3.03)	62 (2.44)	55 (2.17)	
		<i>S<sub>min,2</sub></i>	mm (pulg.)	50 (1.97)	50 (1.97)	50 (1.97)	50 (1.97)	50 (1.97)	50 (1.97)	50 (1.97)	50 (1.97)	50 (1.97)	

INFORMACIÓN DE DISEÑO			Símbolo	Unidades	Diámetro Nominal de la Varilla (mm) – Métrico								
Diámetro Exterior de la Varilla			<i>d</i>	mm (pulg.)	12 (0.47)								
Empotramiento efectivo			<i>h<sub>ef</sub></i>	mm (pulg.)	70 (2.76)			108 (4.25)		144 (5.67)			
Condición del agujero perforado <sup>1</sup>			-	-	2	1 o 2		2	1 o 2		2	1 o 2	
Espesor mínimo del concreto			<i>h</i>	mm (pulg.)	100 (3.94)	130 (5.12)	184 (7.24)	138 (5.43)	168 (6.61)	209 (8.21)	174 (6.85)	204 (8.03)	234 (9.21)
CONCRETO NO FISURADO	Borde y separación mínimos Caso 1 <sup>2</sup>	<i>C<sub>min,1</sub></i>	mm (pulg.)	139 (5.47)	107 (4.21)	76 (2.99)	101 (3.98)	83 (3.27)	67 (2.64)	80 (3.15)	68 (2.68)	60 (2.36)	
		<i>S<sub>min,1</sub></i>	mm (pulg.)	416 (16.38)	320 (12.60)	225 (8.86)	300 (11.81)	247 (9.72)	199 (7.83)	239 (9.41)	204 (8.03)	176 (6.93)	
	Borde y separación mínimos Caso 2 <sup>2</sup>	<i>C<sub>min,2</sub></i>	mm (pulg.)	258 (10.16)	194 (7.64)	131 (5.16)	181 (7.13)	146 (5.75)	114 (4.49)	140 (5.51)	116 (4.57)	99 (3.90)	
		<i>S<sub>min,2</sub></i>	mm (pulg.)	60 (2.36)	60 (2.36)	60 (2.36)	60 (2.36)	60 (2.36)	60 (2.36)	60 (2.36)	60 (2.36)	60 (2.36)	
CONCRETO FISURADO	Borde y separación mínimos Caso 1 <sup>2</sup>	<i>C<sub>min,1</sub></i>	mm (pulg.)	101 (3.98)	78 (3.07)	62 (2.44)	74 (2.91)	61 (2.40)	60 (2.36)	60 (2.36)	60 (2.36)	60 (2.36)	
		<i>S<sub>min,1</sub></i>	mm (pulg.)	303 (11.93)	232 (9.13)	186 (7.32)	217 (8.54)	178 (7.01)	126 (4.96)	168 (6.61)	117 (4.61)	79 (3.11)	
	Borde y separación mínimos Caso 2 <sup>2</sup>	<i>C<sub>min,2</sub></i>	mm (pulg.)	182 (7.17)	136 (5.35)	90 (3.54)	127 (5.00)	101 (3.98)	77 (3.03)	96 (3.78)	79 (3.11)	67 (2.64)	
		<i>S<sub>min,2</sub></i>	mm (pulg.)	60 (2.36)	60 (2.36)	60 (2.36)	60 (2.36)	60 (2.36)	60 (2.36)	60 (2.36)	60 (2.36)	60 (2.36)	

Para SI: 1 pulgada ≅ 25.4 mm

<sup>1</sup> Ver Figura 4 para la descripción de la condición del agujero perforado.

<sup>2</sup> Se permite la interpolación lineal para establecer las combinaciones de la distancia al borde y separación entre el caso 1 y caso 2.

Interpolación lineal para una distancia la borde específica *c*, donde *C<sub>min,1</sub>* < *c* < *C<sub>min,2</sub>*, determinará el espaciado permisible, *s*, de la siguiente manera:

$$s \geq S_{min,2} + \frac{(S_{min,1} - S_{min,2})}{(C_{min,1} - C_{min,2})} (c - C_{min,2})$$

**TABLA 9— COMBINACIONES PRE-CALCULADAS DE DISTANCIA AL BORDE Y SEPARACIÓN PARA VARILLAS HILTI HIT-Z Y HIT-Z-R (Continuación)**

INFORMACIÓN DE DISEÑO			Símbolo	Unidades	Diámetro Nominal de la Varilla (mm) – Métrico								
Diámetro Exterior de la Varilla			<i>d</i>	mm (pulg.)	16 (0.63)								
Empotramiento efectivo			<i>h<sub>ef</sub></i>	mm (pulg.)	96 (3.78)			144 (5.67)		192 (7.56)			
Condición del agujero perforado <sup>1</sup>			-	-	2	1 o 2		2	1 o 2		2	1 o 2	
Espesor mínimo del concreto			<i>h</i>	mm (pulg.)	141 (5.55)	196 (7.72)	237 (9.33)	189 (7.44)	244 (9.61)	269 (10.57)	237 (9.33)	292 (11.50)	312 (12.28)
CONCRETO NO FISURADO	Borde y separación mínimos Caso 1 <sup>2</sup>	<i>c<sub>min,1</sub></i>	mm (pulg.)	158 (6.22)	114 (4.49)	94 (3.70)	118 (4.65)	92 (3.62)	83 (3.27)	94 (3.70)	80 (3.15)	80 (3.15)	
		<i>s<sub>min,1</sub></i>	mm (pulg.)	473 (18.62)	339 (13.35)	281 (11.06)	352 (13.86)	271 (10.67)	248 (9.76)	281 (11.06)	217 (8.54)	188 (7.40)	
	Borde y separación mínimos Caso 2 <sup>2</sup>	<i>c<sub>min,2</sub></i>	mm (pulg.)	289 (11.38)	201 (7.91)	161 (6.34)	209 (8.23)	156 (6.14)	139 (5.47)	161 (6.34)	126 (4.96)	116 (4.57)	
		<i>s<sub>min,2</sub></i>	mm (pulg.)	80 (3.15)	80 (3.15)	80 (3.15)	80 (3.15)	80 (3.15)	80 (3.15)	80 (3.15)	80 (3.15)	80 (3.15)	80 (3.15)
CONCRETO FISURADO	Borde y separación mínimos Caso 1 <sup>2</sup>	<i>c<sub>min,1</sub></i>	mm (pulg.)	116 (4.57)	83 (3.27)	80 (3.15)	86 (3.39)	80 (3.15)	80 (3.15)	80 (3.15)	80 (3.15)	80 (3.15)	
		<i>s<sub>min,1</sub></i>	mm (pulg.)	343 (13.50)	248 (9.76)	211 (8.31)	258 (10.16)	160 (6.30)	129 (5.08)	171 (6.73)	94 (3.70)	81 (3.19)	
	Borde y separación mínimos Caso 2 <sup>2</sup>	<i>c<sub>min,2</sub></i>	mm (pulg.)	204 (8.03)	139 (5.47)	111 (4.37)	146 (5.75)	107 (4.21)	95 (3.74)	111 (4.37)	85 (3.35)	80 (3.15)	
		<i>s<sub>min,2</sub></i>	mm (pulg.)	80 (3.15)	80 (3.15)	80 (3.15)	80 (3.15)	80 (3.15)	80 (3.15)	80 (3.15)	80 (3.15)	80 (3.15)	80 (3.15)

INFORMACIÓN DE DISEÑO			Símbolo	Unidades	Diámetro Nominal de la Varilla (mm) – Métrico								
Diámetro Exterior de la Varilla			<i>d</i>	mm (pulg.)	20 (0.79)								
Empotramiento efectivo			<i>h<sub>ef</sub></i>	mm (pulg.)	100 (3.94)			180 (7.09)		220 (8.66)			
Condición del agujero perforado <sup>1</sup>			-	-	2	1 o 2		2	1 o 2		2	1 o 2	
Espesor mínimo del concreto			<i>h</i>	mm (pulg.)	145 (5.71)	200 (7.87)	282 (11.08)	225 (8.86)	280 (11.02)	335 (13.17)	265 (10.43)	320 (12.60)	370 (14.57)
CONCRETO NO FISURADO	Borde y separación mínimos Caso 1 <sup>2</sup>	<i>c<sub>min,1</sub></i>	mm (pulg.)	235 (9.25)	170 (6.69)	121 (4.76)	152 (5.98)	122 (4.80)	103 (4.06)	129 (5.08)	107 (4.21)	100 (3.94)	
		<i>s<sub>min,1</sub></i>	mm (pulg.)	702 (27.64)	511 (20.12)	362 (14.25)	451 (17.76)	363 (14.29)	301 (11.85)	383 (15.08)	317 (12.48)	252 (9.92)	
	Borde y separación mínimos Caso 2 <sup>2</sup>	<i>c<sub>min,2</sub></i>	mm (pulg.)	436 (17.17)	307 (12.09)	209 (8.23)	269 (10.59)	210 (8.27)	170 (6.69)	224 (8.82)	180 (7.09)	151 (5.94)	
		<i>s<sub>min,2</sub></i>	mm (pulg.)	100 (3.94)	100 (3.94)	100 (3.94)	100 (3.94)	100 (3.94)	100 (3.94)	100 (3.94)	100 (3.94)	100 (3.94)	100 (3.94)
CONCRETO FISURADO	Borde y separación mínimos Caso 1 <sup>2</sup>	<i>c<sub>min,1</sub></i>	mm (pulg.)	176 (6.93)	128 (5.04)	102 (4.02)	114 (4.49)	100 (3.94)	100 (3.94)	100 (3.94)	100 (3.94)	100 (3.94)	
		<i>s<sub>min,1</sub></i>	mm (pulg.)	526 (20.71)	380 (14.96)	298 (11.73)	337 (13.27)	246 (9.69)	163 (6.42)	277 (10.91)	178 (7.01)	113 (4.45)	
	Borde y separación mínimos Caso 2 <sup>2</sup>	<i>c<sub>min,2</sub></i>	mm (pulg.)	318 (12.52)	222 (8.74)	148 (5.83)	193 (7.60)	149 (5.87)	119 (4.69)	159 (6.26)	126 (4.96)	105 (4.13)	
		<i>s<sub>min,2</sub></i>	mm (pulg.)	100 (3.94)	100 (3.94)	100 (3.94)	100 (3.94)	100 (3.94)	100 (3.94)	100 (3.94)	100 (3.94)	100 (3.94)	100 (3.94)

Para SI: 1 pulgada ≅ 25.4 mm

<sup>1</sup> Ver Figura 4 para la descripción de la condición del agujero perforado.

<sup>2</sup> Se permite la interpolación lineal para establecer las combinaciones de la distancia al borde y separación entre el caso 1 y caso 2.

Interpolación lineal para una distancia la borde específica *c*, donde *c<sub>min,1</sub>* < *c* < *c<sub>min,2</sub>*, determinará el espaciado permisible, *s*, de la siguiente manera:

$$s \geq s_{min,2} + \frac{(s_{min,1} - s_{min,2})}{(c_{min,1} - c_{min,2})} (c - c_{min,2})$$

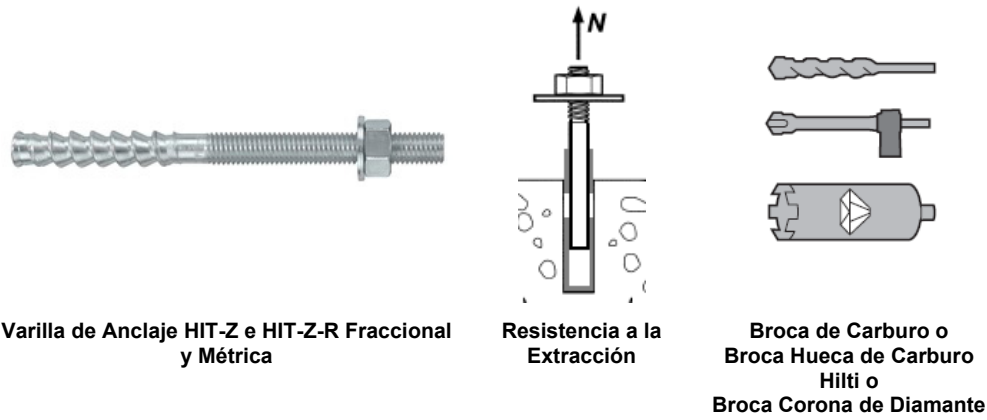

Varilla de Anclaje HIT-Z e HIT-Z-R Fraccional y Métrica

Resistencia a la Extracción

Broca de Carburo o Broca Hueca de Carburo Hilti o Broca Corona de Diamante

**TABLA 10—INFORMACIÓN DE DISEÑO DE LA RESISTENCIA A LA EXTRACCIÓN PARA VARILLAS HILTI HIT-Z Y HIT-Z-R FRACCIONALES Y MÉTRICAS EN AGUJEROS PERFORADOS CON ROTO MARTILLO Y BROCA DE CARBURO (O BROCA HUECA DE CARBURO HILTI) O PERFORADO CON DIAMANTE<sup>1</sup>**

INFORMACIÓN DE DISEÑO		Símbolo	Unidades	Diámetro Nominal de la Varilla Fraccional (pulg.)				Unidades	Diámetro Nominal de la Varilla Métrico (mm)			
				3/8	1/2	5/8	3/4		10	12	16	20
Profundidad de empotramiento mínima		$h_{ef,min}$	pulg. (mm)	2 <sup>3</sup> / <sub>8</sub> (60)	2 <sup>3</sup> / <sub>4</sub> (70)	3 <sup>3</sup> / <sub>4</sub> (95)	4 (102)	mm (pulg.)	60 (2.4)	70 (2.8)	96 (3.8)	100 (3.9)
Profundidad de empotramiento máxima		$h_{ef,max}$	pulg. (mm)	4 <sup>1</sup> / <sub>2</sub> (114)	6 (152)	7 <sup>1</sup> / <sub>2</sub> (190)	8 <sup>1</sup> / <sub>2</sub> (216)	mm (pulg.)	120 (4.7)	144 (5.7)	192 (7.6)	220 (8.7)
Temperatura rango A <sup>2</sup>	Resistencia a la extracción en concreto fisurado	$N_{p,cr}$	lb (kN)	7,952 (35.4)	10,936 (48.6)	21,391 (95.1)	27,930 (124.2)	kN (lb)	39.1 (8,790)	43.8 (9,847)	98.0 (22,032)	127.9 (28,754)
	Resistencia a la extracción en concreto no fisurado	$N_{p,un-cr}$	lb (kN)	7,952 (35.4)	11,719 (52.1)	21,391 (95.1)	28,460 (126.6)	kN (lb)	39.1 (8,790)	46.9 (10,545)	98.0 (22,028)	130.3 (29,293)
Temperatura rango B <sup>2</sup>	Resistencia a la extracción en concreto fisurado	$N_{p,cr}$	lb (kN)	7,952 (35.4)	10,936 (48.6)	21,391 (95.1)	27,930 (124.2)	kN (lb)	39.1 (8,790)	43.8 (9,847)	98.0 (22,032)	127.9 (28,754)
	Resistencia a la extracción en concreto no fisurado	$N_{p,un-cr}$	lb (kN)	7,952 (35.4)	11,719 (52.1)	21,391 (95.1)	28,460 (126.6)	kN (lb)	39.1 (8,790)	46.9 (10,545)	98.0 (22,028)	130.3 (29,293)
Temperatura rango C <sup>2</sup>	Resistencia a la extracción en concreto fisurado	$N_{p,cr}$	lb (kN)	7,182 (31.9)	9,877 (43.9)	19,321 (85.9)	25,227 (112.2)	kN (lb)	35.3 (7,936)	39.5 (8,880)	88.5 (19,897)	115.5 (25,967)
	Resistencia a la extracción en concreto no fisurado	$N_{p,un-cr}$	lb (kN)	7,182 (31.9)	10,585 (47.1)	19,321 (85.9)	25,705 (114.3)	kN (lb)	35.3 (7,936)	42.4 (9,532)	88.5 (19,897)	117.7 (26,461)
Condiciones de instalación	Concreto seco, concreto saturado con agua	Categoría de Anclaje	-	1				-	1			
		$\phi_d, \phi_{vs}$	-	0.65				-	0.65			
Reducción por tensión sísmica		$\alpha_{N,seis}$	-	0.94	1.0			-	1.0	0.89	1.0	

Para SI: 1 pulgada ≅ 25.4 mm, 1 lbf = 4.448 N, 1 psi = 0.006897 MPa.  
 Para unidades libra-pulgada: 1 mm = 0.03937 pulgadas, 1 N = 0.2248 lbf, 1 MPa = 145.0 psi

<sup>1</sup> Temperatura rango A: Temperatura máxima a corto plazo = 130°F (55°C), Temperatura máxima a largo plazo = 110°F (43°C).  
 Temperatura rango B: Temperatura máxima a corto plazo = 176°F (80°C), Temperatura máxima a largo plazo = 110°F (43°C).  
 Temperatura rango C: Temperatura máxima a corto plazo = 248°F (120°C), Temperatura máxima a largo plazo = 162°F (72°C).  
 Las temperaturas elevadas a corto plazo del concreto son aquellas que ocurren a intervalos cortos, por ejemplo, como resultado del ciclo diario. Las temperaturas a largo plazo son constantes a lo largo de periodos significativos de tiempo.



Varillas Roscadas Fraccionales

Resistencia del Acero

TABLA 11—INFORMACIÓN DEL DISEÑO DEL ACERO PARA VARILLAS ROSCADAS FRACCIONALES

INFORMACIÓN DE DISEÑO		Símbolo	Unidades	Diámetro Nominal de la Varilla (pulg.) <sup>1</sup>						
				<sup>3</sup> / <sub>8</sub>	<sup>1</sup> / <sub>2</sub>	<sup>5</sup> / <sub>8</sub>	<sup>3</sup> / <sub>4</sub>	<sup>7</sup> / <sub>8</sub>	1	1 <sup>1</sup> / <sub>4</sub>
Diámetro Exterior de la Varilla		<i>d</i>	pulg. (mm)	0.375 (9.5)	0.5 (12.7)	0.625 (15.9)	0.75 (19.1)	0.875 (22.2)	1 (25.4)	1.25 (31.8)
Área efectiva de la sección transversal de la varilla		<i>A<sub>se</sub></i>	pulg. <sup>2</sup> (mm <sup>2</sup> )	0.0775 (50)	0.1419 (92)	0.2260 (146)	0.3345 (216)	0.4617 (298)	0.6057 (391)	0.9691 (625)
ISO 898-1 Clase 5.8	Resistencia nominal que se rige por la Resistencia del Acero	<i>N<sub>sa</sub></i>	lb (kN)	5,620 (25.0)	10,290 (45.8)	16,385 (72.9)	24,250 (107.9)	33,470 (148.9)	43,910 (195.3)	70,260 (312.5)
		<i>V<sub>sa</sub></i>	lb (kN)	3,370 (15.0)	6,175 (27.5)	9,830 (43.7)	14,550 (64.7)	20,085 (89.3)	26,345 (117.2)	42,155 (187.5)
	Reducción para el cortante sísmico	$\alpha_{v,seis}$	-	0.70						
	Factor $\phi$ de reducción de resistencia para la tensión <sup>2</sup>	$\phi$	-	0.65						
		Factor $\phi$ de reducción de resistencia para el cortante <sup>2</sup>	$\phi$	0.60						
ASTM A193 B7	Resistencia nominal que se rige por la Resistencia del Acero	<i>N<sub>sa</sub></i>	lb (kN)	9,685 (43.1)	17,735 (78.9)	28,250 (125.7)	41,810 (186.0)	57,710 (256.7)	75,710 (336.8)	121,135 (538.8)
		<i>V<sub>sa</sub></i>	lb (kN)	5,810 (25.9)	10,640 (47.3)	16,950 (75.4)	25,085 (111.6)	34,625 (154.0)	45,425 (202.1)	72,680 (323.3)
	Reducción para el cortante sísmico	$\alpha_{v,seis}$	-	0.70						
	Factor $\phi$ de reducción de resistencia para la tensión <sup>2</sup>	$\phi$	-	0.75						
		Factor $\phi$ de reducción de resistencia para el cortante <sup>2</sup>	$\phi$	0.65						
ASTM F1554 Gr. 36	Resistencia nominal que se rige por la Resistencia del Acero	<i>N<sub>sa</sub></i>	lb (kN)	- (36.6)	8,230 (36.6)	13,110 (58.3)	19,400 (86.3)	26,780 (119.1)	35,130 (156.3)	56,210 (250.0)
		<i>V<sub>sa</sub></i>	lb (kN)	- (22.0)	4,940 (22.0)	7,865 (35.0)	11,640 (51.8)	16,070 (71.5)	21,080 (93.8)	33,725 (150.0)
	Factor de reducción, cortante sísmico	$\alpha_{v,seis}$	-	0.6						
	Factor $\phi$ de reducción de resistencia para la tensión <sup>2</sup>	$\phi$	-	0.75						
		Factor $\phi$ de reducción de resistencia para el cortante <sup>2</sup>	$\phi$	0.65						
ASTM F1554 Gr. 55	Resistencia nominal que se rige por la Resistencia del Acero	<i>N<sub>sa</sub></i>	lb (kN)	- (47.4)	10,645 (47.4)	16,950 (75.4)	25,090 (111.6)	34,630 (154.0)	45,430 (202.1)	72,685 (323.3)
		<i>V<sub>sa</sub></i>	lb (kN)	- (28.4)	6,385 (28.4)	10,170 (45.2)	15,055 (67.0)	20,780 (92.4)	27,260 (121.3)	43,610 (194.0)
	Factor de reducción, cortante sísmico	$\alpha_{v,seis}$	-	0.7						
	Factor $\phi$ de reducción de resistencia para la tensión <sup>2</sup>	$\phi$	-	0.75						
		Factor $\phi$ de reducción de resistencia para el cortante <sup>2</sup>	$\phi$	0.65						
ASTM F1554 Gr. 105	Resistencia nominal que se rige por la Resistencia del Acero	<i>N<sub>sa</sub></i>	lb (kN)	- (78.9)	17,740 (78.9)	28,250 (125.7)	41,815 (186.0)	57,715 (256.7)	75,715 (336.8)	121,135 (538.8)
		<i>V<sub>sa</sub></i>	lb (kN)	- (47.4)	10,645 (47.4)	16,950 (75.4)	25,090 (111.6)	34,630 (154.0)	45,430 (202.1)	72,680 (323.3)
	Factor de reducción, cortante sísmico	$\alpha_{v,seis}$	-	0.7						
	Factor $\phi$ de reducción de resistencia para la tensión <sup>2</sup>	$\phi$	-	0.75						
		Factor $\phi$ de reducción de resistencia para el cortante <sup>2</sup>	$\phi$	0.65						
ASTM F593, CW Inoxidable	Resistencia nominal que se rige por la Resistencia del Acero	<i>N<sub>sa</sub></i>	lb (kN)	7,750 (34.5)	14,190 (63.1)	22,600 (100.5)	28,435 (126.5)	39,245 (174.6)	51,485 (229.0)	-
		<i>V<sub>sa</sub></i>	lb (kN)	4,650 (20.7)	8,515 (37.9)	13,560 (60.3)	17,060 (75.9)	23,545 (104.7)	30,890 (137.4)	-
	Factor de reducción, cortante sísmico	$\alpha_{v,seis}$	-	0.7						
	Factor $\phi$ de reducción de resistencia para la tensión <sup>2</sup>	$\phi$	-	0.65						
		Factor $\phi$ de reducción de resistencia para el cortante <sup>2</sup>	$\phi$	0.60						
ASTM A193, Gr. 8(M), Clase 1 Inoxidable	Resistencia nominal que se rige por la Resistencia del Acero	<i>N<sub>sa</sub></i>	lb (kN)	-	-	-	-	-	-	55,240 (245.7)
		<i>V<sub>sa</sub></i>	lb (kN)	-	-	-	-	-	-	33,145 (147.4)
	Factor de reducción, cortante sísmico	$\alpha_{v,seis}$	-	0.80						
	Factor $\phi$ de reducción de resistencia para la tensión <sup>2</sup>	$\phi$	-	0.75						
		Factor $\phi$ de reducción de resistencia para el cortante <sup>2</sup>	$\phi$	0.65						

Para **SI**: 1 pulgada = 25.4 mm, 1 lbf = 4.448 N. Para unidades **libra-pulgada**: 1 mm = 0.03937 pulgadas, 1 N = 0.2248 lbf

<sup>1</sup> Los valores proporcionados para los tipos de materiales de la varilla común se basan en resistencias especificadas y calculadas de acuerdo con ACI 318-19 Ec. (17.6.1.2) y Ec. (17.7.1.2b), ACI 318-14 Ec. (17.4.1.2) y Ec. (17.5.1.2b) o ACI 318-11 Ec. (D-2) y Ec. (D-29). Las tuercas y arandelas deben ser apropiadas para la varilla.

<sup>2</sup> El factor de reducción de resistencia se aplica cuando se usan las cargas combinadas del IBC o ACI 318 y se cumplen los requisitos de ACI 318-19 17.5.3, ACI 318-14 17.3.3 o ACI 318-11 D.4.3, según se aplique. Si se usan las cargas combinadas del Apéndice C de ACI 318-11, el valor apropiado del factor de reducción de resistencia debe determinarse de acuerdo con ACI 318-11 D.4.4.



Barras de Refuerzo Fraccionales

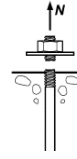

Resistencia del Acero

TABLA 11A—INFORMACIÓN DEL DISEÑO DEL ACERO PARA BARRAS DE REFUERZO FRACCIONALES

INFORMACIÓN DE DISEÑO		Símbolo	Unidades	Tamaño nominal de la barra de refuerzo								
				#3	#4	#5	#6	#7	#8	#9	#10	
Diámetro nominal de la barra		$d$	pulg. (mm)	<sup>3</sup> / <sub>8</sub> (9.5)	<sup>1</sup> / <sub>2</sub> (12.7)	<sup>5</sup> / <sub>8</sub> (15.9)	<sup>3</sup> / <sub>4</sub> (19.1)	<sup>7</sup> / <sub>8</sub> (22.2)	1 (25.4)	1.128 (28.7)	1.270 (32.3)	
Área efectiva de la sección transversal de la barra		$A_{se}$	pulg. <sup>2</sup> (mm <sup>2</sup> )	0.11 (71)	0.2 (129)	0.31 (199)	0.44 (284)	0.6 (387)	0.79 (510)	1.0 (645)	1.27 (819)	
ASTM A615 Grado 40	Resistencia nominal que se rige por la resistencia del acero		$N_{sa}$	lb (kN)	6,600 (29.4)	12,000 (53.4)	18,600 (82.7)	26,400 (117.4)	36,000 (160.1)	47,400 (210.9)	60,000 (266.9)	76,200 (339.0)
			$V_{sa}$	lb (kN)	3,960 (17.6)	7,200 (32.0)	11,160 (49.6)	15,840 (70.5)	21,600 (96.1)	28,440 (126.5)	36,000 (160.1)	45,720 (203.4)
	Reducción para el cortante sísmico		$\alpha_{V,seis}$	-	0.70							
	Factor $\phi$ de reducción de resistencia para la tensión <sup>2</sup>		$\phi$	-	0.65							
	Factor $\phi$ de reducción de resistencia para el cortante <sup>2</sup>		$\phi$	-	0.60							
ASTM A615 Grado 60	Resistencia nominal que se rige por la Resistencia del Acero		$N_{sa}$	lb (kN)	8,800 (39.1)	16,000 (71.2)	24,800 (110.3)	35,200 (156.6)	48,000 (213.5)	63,200 (281.1)	80,000 (355.9)	101,600 (451.9)
			$V_{sa}$	lb (kN)	5,280 (23.5)	9,600 (42.7)	14,880 (66.2)	21,120 (93.9)	28,800 (128.1)	37,920 (168.7)	48,000 (213.5)	60,960 (271.2)
	Reducción para el cortante sísmico		$\alpha_{V,seis}$	-	0.70							
	Factor $\phi$ de reducción de resistencia para la tensión <sup>2</sup>		$\phi$	-	0.65							
	Factor $\phi$ de reducción de resistencia para el cortante <sup>2</sup>		$\phi$	-	0.60							
ASTM A706 Grado 60	Resistencia nominal que se rige por la Resistencia del Acero		$N_{sa}$	lb (kN)	8,800 (39.1)	16,000 (71.2)	24,800 (110.3)	35,200 (156.6)	48,000 (213.5)	63,200 (281.1)	80,000 (355.9)	101,600 (452.0)
			$V_{sa}$	lb (kN)	5,280 (23.5)	9,600 (42.7)	14,880 (66.2)	21,120 (94.0)	28,800 (128.1)	37,920 (168.7)	48,000 (213.5)	60,960 (271.2)
	Reducción para el cortante sísmico		$\alpha_{V,seis}$	-	0.70							
	Factor $\phi$ de reducción de resistencia para la tensión <sup>2</sup>		$\phi$	-	0.75							
	Factor $\phi$ de reducción de resistencia para el cortante <sup>2</sup>		$\phi$	-	0.65							

Para **SI**: 1 pulgada = 25.4 mm, 1 lbf = 4.448 N. Para unidades **libra-pulgada**: 1 mm = 0.03937 pulgadas, 1 N = 0.2248 lbf

<sup>1</sup> Los valores proporcionados para los tipos de materiales de la varilla común se basan en resistencias especificadas y calculadas de acuerdo con ACI 318-19 Ec. (17.6.1.2) y Ec. (17.7.1.2b), ACI 318-14 Ec. (17.4.1.2) y Ec. (17.5.1.2b) o ACI 318-11 Ec. (D-2) y Ec. (D-29). Las tuercas y arandelas deben ser apropiadas para la varilla.

<sup>2</sup> El factor de reducción de resistencia se aplica cuando se usan las cargas combinadas del IBC o ACI 318 y se cumplen los requisitos de ACI 318-19 17.5.3, ACI 318-14 17.3.3 o ACI 318-11 D.4.3, según se aplique. Si se usan las cargas combinadas del Apéndice C de ACI 318-11, el valor apropiado del factor de reducción de resistencia debe determinarse de acuerdo con ACI 318-11 D.4.4.

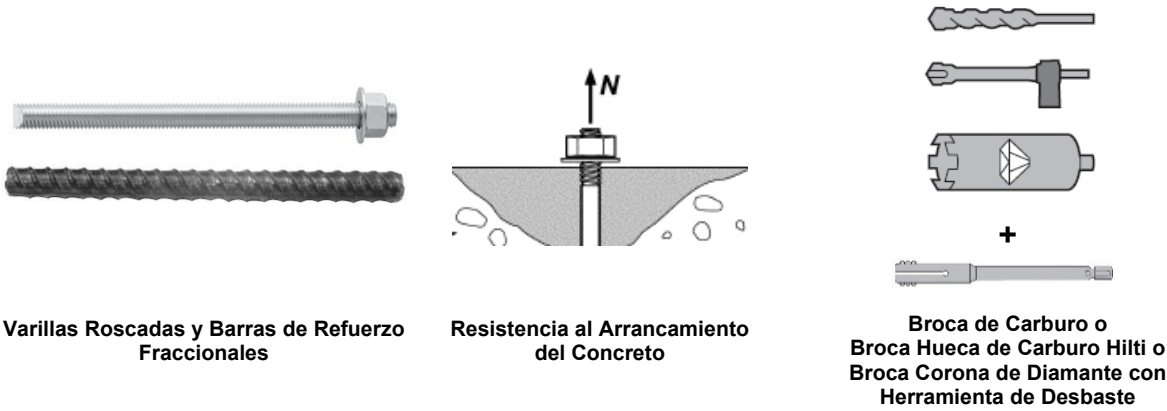

Varillas Roscadas y Barras de Refuerzo Fraccionales

Resistencia al Arrancamiento del Concreto

Broca de Carburo o Broca Hueca de Carburo Hilti o Broca Corona de Diamante con Herramienta de Desbaste

TABLA 12—INFORMACIÓN DE DISEÑO DEL ARRANCAMIENTO DEL CONCRETO PARA VARILLAS ROSCADAS Y BARRAS DE REFUERZO FRACCIONALES EN AGUJEROS PERFORADOS CON ROTO MARTILLO Y BROCA DE CARBURO (O BROCA HUECA DE CARBURO HILTI) O PERFORADO CON BROCA CORONA DE DIAMANTE Y DESBASTADO CON HERRAMIENTA DE DESBASTE HILTI<sup>1</sup>

INFORMACIÓN DE DISEÑO	Símbolo	Unidades	Diámetro Nominal de la Varilla (pulg.) / Tamaño de la barra de refuerzo							
			3/8 o #3	1/2 o #4	5/8 o #5	3/4 o #6	7/8 o #7	1 o #8	#9	1 1/4 o #10
Factor de efectividad para concreto fisurado	$k_{c,cr}$	pulg-lb (SI)	17 (7.1)							
Factor de efectividad para concreto no fisurado	$k_{c,uncr}$	pulg-lb (SI)	24 (10)							
Empotramiento mínimo	$h_{ef,min}$	pulg. (mm)	2 3/8 (60)	2 3/4 (70)	3 1/8 (79)	3 1/2 (89)	3 1/2 (89)	4 (102)	4 1/2 (114)	5 (127)
Empotramiento máximo	$h_{ef,max}$	pulg. (mm)	7 1/2 (191)	10 (254)	12 1/2 (318)	15 (381)	17 1/2 (445)	20 (508)	22 1/2 (572)	25 (635)
Separación mínima entre anclajes <sup>3</sup>	$s_{min}$	pulg. (mm)	1 7/8 (48)	2 1/2 (64)	3 1/8 (79)	3 3/4 (95)	4 3/8 (111)	5 (127)	5 5/8 (143)	6 1/4 (159)
Distancia mínima al borde (Varillas roscadas)	$c_{min}$	pulg. (mm)	1 3/4 (45)	1 3/4 (45)	2 <sup>(3)</sup> (50) <sup>(3)</sup>	2 1/8 <sup>(3)</sup> (55) <sup>(3)</sup>	2 1/4 <sup>(3)</sup> (60) <sup>(3)</sup>	2 3/4 <sup>(3)</sup> (70) <sup>(3)</sup>	n/a	3 1/8 <sup>(3)</sup> (80) <sup>(3)</sup>
Distancia mínima al borde (Barras de refuerzo) <sup>3</sup>	$c_{min}$	-	5d; o ver Sección 4.1.9.2 de este reporte para el diseño con distancias mínimas al borde reducidas							
Espesor mínimo del concreto	$h_{min}$	pulg. (mm)	$h_{ef} + 1 1/4$ ( $h_{ef} + 30$ )			$h_{ef} + 2d_o^{(4)}$				
Distancia crítica al borde – hendimiento (para concreto no fisurado)	$c_{ac}$	-	Ver Sección 4.1.10.2 de este reporte.							
Factor de reducción de resistencia para la tensión, modos de falla del concreto, Condición B (sin reforzamiento suplementario) <sup>2</sup>	$\phi$	-	0.65							
Factor de reducción de resistencia para el cortante, modos de falla del concreto, Condición B (sin reforzamiento suplementario) <sup>2</sup>	$\phi$	-	0.70							

Parar SI: 1 pulgada ≅ 25.4 mm, 1 lbf = 4.448 N, 1 psi = 0.006897 MPa.  
 Para unidades libra-pulgada: 1 mm = 0.03937 pulgadas, 1 N = 0.2248 lbf, 1 MPa = 145.0 psi

<sup>1</sup> Información de ajuste adicional se describe en la Figura 6, Instrucciones de instalación impresas del fabricante(MPII).  
<sup>2</sup> El factor de reducción de resistencia se aplica cuando se usan las cargas combinadas del IBC o ACI 318 y se cumplen los requisitos de ACI 318-19 17.5.3, ACI 318-14 17.3.3 o ACI 318-11 D.4.3, según se aplique. Si se usan las cargas combinadas del Apéndice C de ACI 318-11, el valor apropiado del factor de reducción de resistencia debe determinarse de acuerdo con ACI 318-11 D.4.4.  
<sup>3</sup> Para instalaciones con distancia al borde de 1 3/4-pulgada, consulte la Sección 4.1.9.2 para los requerimientos de espaciado y torque máximo.  
<sup>4</sup>  $d_o$  = diámetro del agujero.

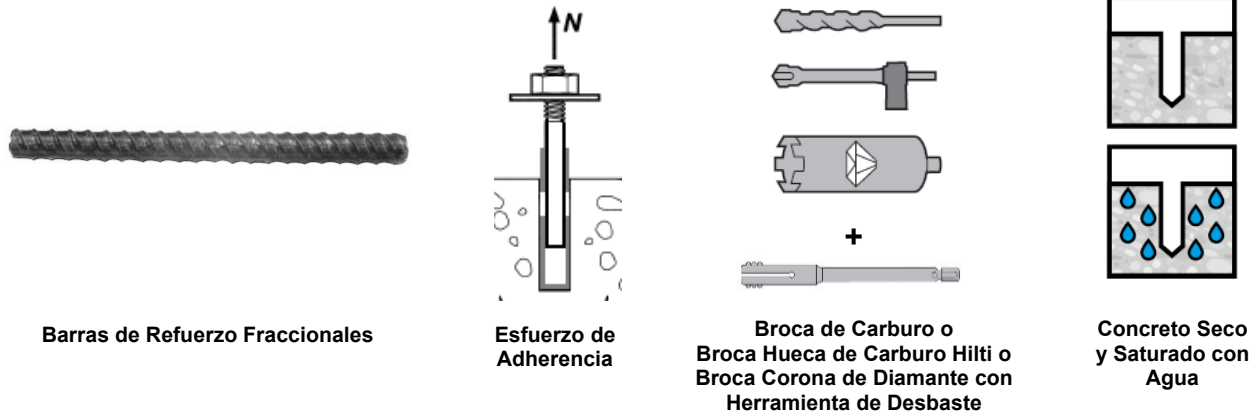

**TABLA 13—INFORMACIÓN DE DISEÑO DEL ESFUERZO DE ADHERENCIA PARA BARRAS DE REFUERZO FRACCIONALES EN AGUJEROS PERFORADOS CON ROTO MARTILLO Y BROCA DE CARBURO (O BROCA HUECA DE CARBURO HILTI) O PERFORADO CON BROCA CORONA DE DIAMANTE Y DESBASTADO CON HERRAMIENTA DE DESBASTE HILTI<sup>1</sup>**

INFORMACIÓN DE DISEÑO		Símbolo	Unidades	Tamaño nominal de la barra de refuerzo							
				#3	#4	#5	#6	#7	#8	#9	#10
Empotramiento mínimo		$h_{ef,min}$	pulg. (mm)	2 <sup>3</sup> / <sub>8</sub> (60)	2 <sup>3</sup> / <sub>4</sub> (70)	3 <sup>1</sup> / <sub>8</sub> (79)	3 <sup>1</sup> / <sub>2</sub> (89)	3 <sup>1</sup> / <sub>2</sub> (89)	4 (102)	4 <sup>1</sup> / <sub>2</sub> (114)	5 (127)
Empotramiento máximo		$h_{ef,max}$	pulg. (mm)	7 <sup>1</sup> / <sub>2</sub> (191)	10 (254)	12 <sup>1</sup> / <sub>2</sub> (318)	15 (381)	17 <sup>1</sup> / <sub>2</sub> (445)	20 (508)	22 <sup>1</sup> / <sub>2</sub> (572)	25 (635)
Temperatura rango A <sup>2</sup>	Esfuerzo de adherencia característico en concreto fisurado	$\tau_{k,cr}$	psi (MPa)	1,080 (7.4)	1,080 (7.4)	1,090 (7.5)	1,090 (7.5)	835 (5.7)	840 (5.8)	850 (5.9)	850 (5.9)
	Esfuerzo característico de adherencia en concreto no fisurado	$\tau_{k,uncr}$	psi (MPa)	1,560 (10.8)	1,560 (10.8)	1,560 (10.8)	1,560 (10.8)	1,560 (10.8)	1,560 (10.8)	1,560 (10.8)	1,560 (10.8)
Temperatura rango B <sup>2</sup>	Esfuerzo característico de adherencia en concreto fisurado	$\tau_{k,cr}$	psi (MPa)	1,080 (7.4)	1,080 (7.4)	1,090 (7.5)	1,090 (7.5)	835 (5.7)	840 (5.8)	850 (5.9)	850 (5.9)
	Esfuerzo característico de adherencia en concreto no fisurado	$\tau_{k,uncr}$	psi (MPa)	1,560 (10.8)	1,560 (10.8)	1,560 (10.8)	1,560 (10.8)	1,560 (10.8)	1,560 (10.8)	1,560 (10.8)	1,560 (10.8)
Temperatura rango C <sup>2</sup>	Esfuerzo característico de adherencia en concreto fisurado	$\tau_{k,cr}$	psi (MPa)	885 (6.1)	890 (6.1)	895 (6.2)	895 (6.2)	685 (4.7)	690 (4.8)	700 (4.8)	700 (4.8)
	Esfuerzo característico de adherencia en concreto no fisurado	$\tau_{k,uncr}$	psi (MPa)	1,280 (8.8)	1,280 (8.8)	1,280 (8.8)	1,280 (8.8)	1,280 (8.8)	1,280 (8.8)	1,280 (8.8)	1,280 (8.8)
Condiciones de instalación permisibles	Concreto seco and concreto saturado con agua	Categoría de Anclaje	-	1							
		$\phi_d, \phi_{ws}$	-	0.65							
Reducción por tensión sísmica	Perforado con rotomartillo	$\alpha_{N,seis}$	-	0.80			0.85	0.90	0.95	1.0	
	Perforado con diamante + desbaste	$\alpha_{N,seis}$	-	N/A	0.71	0.77	0.82	0.95	0.79	0.83	

Para SI: 1 pulgada ≅ 25.4 mm, 1 lbf = 4.448 N, 1 psi = 0.006897 MPa.  
 Para unidades libra-pulgada: 1 mm = 0.03937 pulgadas, 1 N = 0.2248 lbf, 1 MPa = 145.0 psi



<sup>1</sup> Los valores del esfuerzo de adherencia corresponden a la resistencia del concreto a la compresión  $f'_c = 2,500$  psi (17.2 MPa). Para la resistencia a la compresión del concreto,  $f'_c$ , entre 2,500 psi (17.2 MPa) y 8,000 psi (55.2 MPa), el esfuerzo característico de adherencia tabulado puede incrementar por el factor de  $(f'_c / 2,500)^{0.1}$  [Para SI:  $(f'_c / 17.2)^{0.1}$ ]. Ver la Sección 4.1.4 de este reporte para la determinación del esfuerzo de adherencia.

<sup>2</sup> Temperatura rango A: Temperatura máxima a corto plazo = 130°F (55°C), Temperatura máxima a largo plazo = 110°F (43°C).  
 Temperatura rango B: Temperatura máxima a corto plazo = 176°F (80°C), Temperatura máxima a largo plazo = 110°F (43°C).  
 Temperatura rango C: Temperatura máxima a corto plazo = 248°F (120°C), Temperatura máxima a largo plazo = 162°F (72°C).  
 Las temperaturas elevadas a corto plazo del concreto son aquellas que ocurren a intervalos cortos, por ejemplo, como resultado del ciclo diario. Las temperaturas a largo plazo son constantes a lo largo de periodos significativos de tiempo.

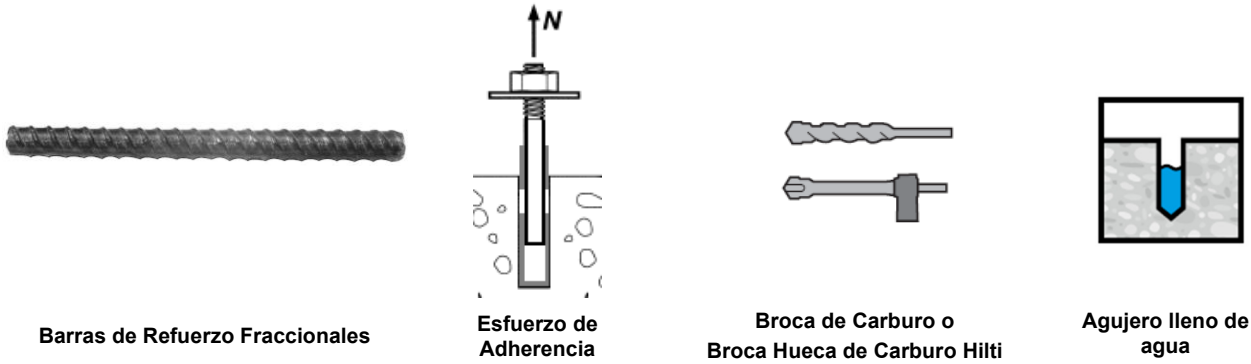



**TABLA 14—INFORMACIÓN DE DISEÑO DEL ESFUERZO DE ADHERENCIA PARA BARRAS DE REFUERZO FRACCIONALES EN AGUJEROS PERFORADOS CON ROTO MARTILLO Y BROCA DE CARBURO (O BROCA HUECA DE CARBURO HILTI)**

INFORMACIÓN DE DISEÑO		Símbolo	Unidades	Tamaño Nominal de la barra de refuerzo							
				#3	#4	#5	#6	#7	#8	#9	#10
Empotramiento mínimo		$h_{ef,min}$	pulg. (mm)	2 <sup>3</sup> / <sub>8</sub> (60)	2 <sup>3</sup> / <sub>4</sub> (70)	3 <sup>1</sup> / <sub>8</sub> (79)	3 <sup>1</sup> / <sub>2</sub> (89)	3 <sup>1</sup> / <sub>2</sub> (89)	4 (102)	4 <sup>1</sup> / <sub>2</sub> (114)	5 (127)
Empotramiento máximo		$h_{ef,max}$	pulg. (mm)	7 <sup>1</sup> / <sub>2</sub> (191)	10 (254)	12 <sup>1</sup> / <sub>2</sub> (318)	15 (381)	17 <sup>1</sup> / <sub>2</sub> (445)	20 (508)	22 <sup>1</sup> / <sub>2</sub> (572)	25 (635)
Temperatura rango A <sup>2</sup>	Esfuerzo característico de adherencia en concreto fisurado	$\bar{u}_{k,cr}$	psi (MPa)	1,050 (7.2)	1,050 (7.2)	1,070 (7.4)	1,070 (7.4)	820 (5.7)	820 (5.7)	830 (5.7)	830 (5.7)
	Esfuerzo característico de adherencia en concreto no fisurado	$\bar{u}_{k,un-cr}$	psi (MPa)	1,520 (10.5)	1,520 (10.5)	1,520 (10.5)	1,520 (10.5)	1,520 (10.5)	1,520 (10.5)	1,520 (10.5)	1,520 (10.5)
Temperatura rango B <sup>2</sup>	Esfuerzo característico de adherencia en concreto fisurado	$\bar{u}_{k,cr}$	psi (MPa)	1,050 (7.2)	1,050 (7.2)	1,070 (7.4)	1,070 (7.4)	820 (5.7)	820 (5.7)	830 (5.7)	830 (5.7)
	Esfuerzo característico de adherencia en concreto no fisurado	$\bar{u}_{k,un-cr}$	psi (MPa)	1,520 (10.5)	1,520 (10.5)	1,520 (10.5)	1,520 (10.5)	1,520 (10.5)	1,520 (10.5)	1,520 (10.5)	1,520 (10.5)
Temperatura rango C <sup>2</sup>	Esfuerzo característico de adherencia en concreto fisurado	$\bar{u}_{k,cr}$	psi (MPa)	865 (6.0)	865 (6.0)	875 (6.1)	875 (6.1)	670 (4.6)	680 (4.7)	680 (4.7)	680 (4.7)
	Esfuerzo característico de adherencia en concreto no fisurado	$\bar{u}_{k,un-cr}$	psi (MPa)	1,250 (8.6)	1,250 (8.6)	1,250 (8.6)	1,250 (8.6)	1,250 (8.6)	1,250 (8.6)	1,250 (8.6)	1,250 (8.6)
Condiciones de instalación permisibles	Agujero lleno de agua 	Categoría de anclaje	-	3							
		$\phi_{Mf}$	-	0.45							
Reducción por tensión sísmica	Perforado con rotomartillo 	$\alpha_{N,seis}$	-	0.80			0.85	0.90	0.95	1.0	

Para SI: 1 pulgada ≡ 25.4 mm, 1 lbf = 4.448 N, 1 psi = 0.006897 MPa.

Para unidades libra-pulgada: 1 mm = 0.03937 pulgadas, 1 N = 0.2248 lbf, 1 MPa = 145.0 psi

<sup>1</sup> Los valores del esfuerzo de adherencia corresponden a la resistencia del concreto a la compresión  $f'_c = 2,500$  psi (17.2 MPa). Para la resistencia a la compresión del concreto,  $f'_c$ , entre 2,500 psi (17.2 MPa) y 8,000 psi (55.2 MPa), el esfuerzo característico de adherencia tabulado puede incrementar por el factor de  $(f'_c / 2,500)^{0.1}$  [Para SI:  $(f'_c / 17.2)^{0.1}$ ]. Ver la Sección 4.1.4 de este reporte para la determinación del esfuerzo de adherencia.

<sup>2</sup> Temperatura rango A: Temperatura máxima a corto plazo = 130°F (55°C), Temperatura máxima a largo plazo = 110°F (43°C).

Temperatura rango B: Temperatura máxima a corto plazo = 176°F (80°C), Temperatura máxima a largo plazo = 110°F (43°C).

Temperatura rango C: Temperatura máxima a corto plazo = 248°F (120°C), Temperatura máxima a largo plazo = 162°F (72°C).

Las temperaturas elevadas a corto plazo del concreto son aquellas que ocurren a intervalos cortos, por ejemplo, como resultado del ciclo diario. Las temperaturas a largo plazo son constantes a lo largo de periodos significativos de tiempo.

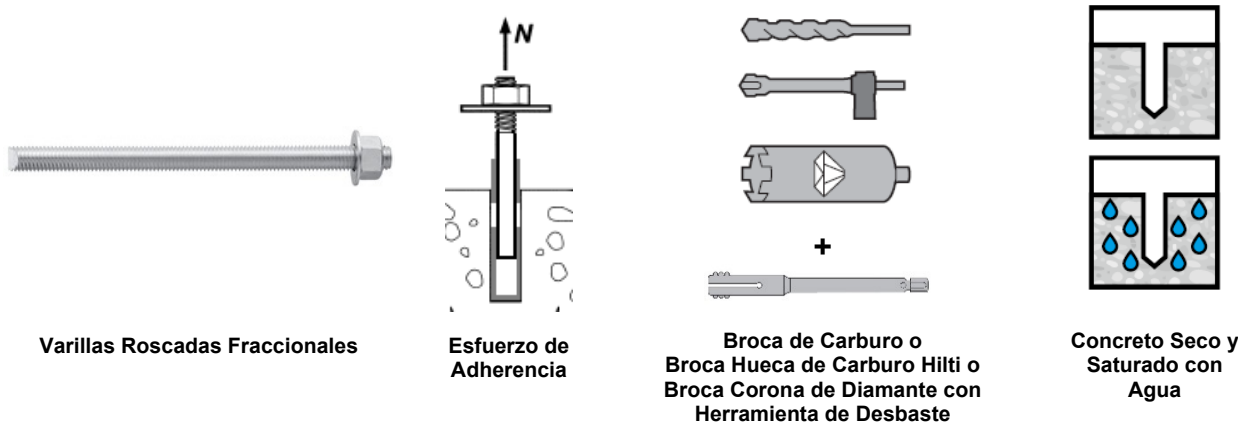

Varillas Roscadas Fraccionales

Esfuerzo de Adherencia

Broca de Carburo o Broca Hueca de Carburo Hilti o Broca Corona de Diamante con Herramienta de Desbaste

Concreto Seco y Saturado con Agua

TABLA 15—INFORMACIÓN DE DISEÑO DEL ESFUERZO DE ADHERENCIA PARA VARILLAS ROSCADAS FRACCIONALES EN AGUJEROS PERFORADOS CON ROTO MARTILLO Y BROCA DE CARBURO (O BROCA HUECA DE CARBURO HILTI) O PERFORADO CON BROCA CORONA DE DIAMANTE Y DESBASTADO CON HERRAMIENTA DE DESBASTE HILTI<sup>1</sup>

INFORMACIÓN DE DISEÑO		Símbolo	Unidades	Diámetro Nominal de la Varilla (pulg.)						
				3/8	1/2	5/8	3/4	7/8	1	1 1/4
Empotramiento mínimo		$h_{ef,min}$	pulg. (mm)	2 3/8 (60)	2 3/4 (70)	3 1/8 (79)	3 1/2 (89)	3 1/2 (89)	4 (102)	5 (127)
Empotramiento máximo		$h_{ef,max}$	pulg. (mm)	7 1/2 (191)	10 (254)	12 1/2 (318)	15 (381)	17 1/2 (445)	20 (508)	25 (635)
Temperatura rango A <sup>2</sup>	Esfuerzo característico de adherencia en concreto fisurado	$\tau_{k,cr}$	psi (MPa)	1,045 (7.2)	1,135 (7.8)	1,170 (8.1)	1,260 (8.7)	1,290 (8.9)	1,325 (9.1)	1,380 (9.5)
	Esfuerzo característico de adherencia en concreto no fisurado	$\tau_{k,un-cr}$	psi (MPa)	2,220 (15.3)	2,220 (15.3)	2,220 (15.3)	2,220 (15.3)	2,220 (15.3)	2,220 (15.3)	2,220 (15.3)
Temperatura rango B <sup>2</sup>	Esfuerzo característico de adherencia en concreto fisurado	$\tau_{k,cr}$	psi (MPa)	1,045 (7.2)	1,135 (7.8)	1,170 (8.1)	1,260 (8.7)	1,290 (8.9)	1,325 (9.1)	1,380 (9.5)
	Esfuerzo característico de adherencia en concreto no fisurado	$\tau_{k,un-cr}$	psi (MPa)	2,220 (15.3)	2,220 (15.3)	2,220 (15.3)	2,220 (15.3)	2,220 (15.3)	2,220 (15.3)	2,220 (15.3)
Temperatura rango C <sup>2</sup>	Esfuerzo característico de adherencia en concreto fisurado	$\tau_{k,cr}$	psi (MPa)	855 (5.9)	930 (6.4)	960 (6.6)	1,035 (7.1)	1,055 (7.3)	1,085 (7.5)	1,130 (7.8)
	Esfuerzo característico de adherencia en concreto no fisurado	$\tau_{k,un-cr}$	psi (MPa)	1,820 (12.6)	1,820 (12.6)	1,820 (12.6)	1,820 (12.6)	1,820 (12.6)	1,820 (12.6)	1,820 (12.6)
Condiciones de instalación permisibles	Concreto Seco y Saturado con Agua 	Categoría de Anclaje	-	1						
		$\phi_s, \phi_{ws}$	-	0.65						
Reducción por tensión sísmica	Perforado con rotomartillo 	$\alpha_{N,seis}$	-	0.88	0.99	0.99	1.0	1.0	0.95	0.99
	Perforado con diamante + desbaste 	$\alpha_{N,seis}$	-	N/A		0.88	0.96	0.96	1.0	0.82

Para SI: 1 pulgada  $\equiv$  25.4 mm, 1 lbf = 4.448 N, 1 psi = 0.006897 MPa.  
 Para unidades libra-pulgada: 1 mm = 0.03937 pulgadas, 1 N = 0.2248 lbf, 1 MPa = 145.0 psi

<sup>1</sup> Los valores del esfuerzo de adherencia corresponden a la resistencia del concreto a la compresión  $f'_c = 2,500$  psi (17.2 MPa). Para la resistencia a la compresión del concreto,  $f'_c$ , entre 2,500 psi (17.2 MPa) y 8,000 psi (55.2 MPa), el esfuerzo característico de adherencia tabulado puede incrementar por el factor de  $(f'_c / 2,500)^{0.1}$  [Para SI:  $(f'_c / 17.2)^{0.1}$ ]. Ver la Sección 4.1.4 de este reporte para la determinación del esfuerzo de adherencia.

<sup>2</sup> Temperatura rango A: Temperatura máxima a corto plazo = 130°F (55°C), Temperatura máxima a largo plazo = 110°F (43°C).  
 Temperatura rango B: Temperatura máxima a corto plazo = 176°F (80°C), Temperatura máxima a largo plazo = 110°F (43°C).  
 Temperatura rango C: Temperatura máxima a corto plazo = 248°F (120°C), Temperatura máxima a largo plazo = 162°F (72°C).  
 Las temperaturas elevadas a corto plazo del concreto son aquellas que ocurren en intervalos cortos, por ejemplo, como resultado del ciclo diario. Las temperaturas a largo plazo son constantes a lo largo de periodos significativos de tiempo.

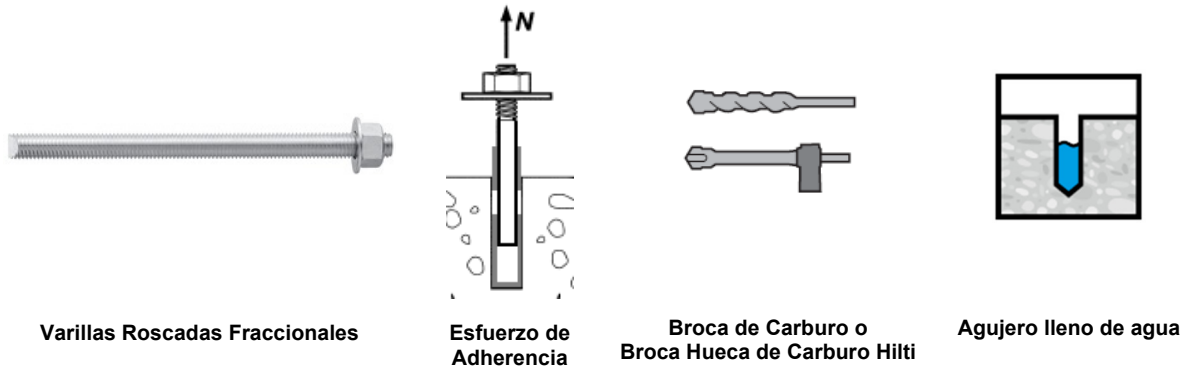

**TABLA 16—INFORMACIÓN DE DISEÑO DEL ESFUERZO DE ADHERENCIA PARA VARILLAS ROSCADAS FRACCIONALES EN AGUJEROS PERFORADOS CON ROTO MARTILLO Y BROCA DE CARBURO (O BROCA HUECA DE CARBURO HILTI)**

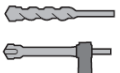
INFORMACIÓN DE DISEÑO		Símbolo	Unidades	Diámetro Nominal de la Varilla (pulg.)						
				3/8	1/2	5/8	3/4	7/8	1	1 1/4
Empotramiento mínimo		$h_{ef,min}$	pulg. (mm)	2 3/8 (60)	2 3/4 (70)	3 1/8 (79)	3 1/2 (89)	3 1/2 (89)	4 (102)	5 (127)
Empotramiento máximo		$h_{ef,max}$	pulg. (mm)	7 1/2 (191)	10 (254)	12 1/2 (318)	15 (381)	17 1/2 (445)	20 (508)	25 (635)
Temperatura rango A <sup>2</sup>	Esfuerzo característico de adherencia en concreto fisurado	$\tau_{k,cr}$	psi (MPa)	825 (5.7)	875 (6.0)	865 (6.0)	910 (6.3)	890 (6.1)	885 (6.1)	840 (5.8)
	Esfuerzo característico de adherencia en concreto no fisurado	$\tau_{k,uncr}$	psi (MPa)	1,755 (12.1)	1,710 (11.8)	1,645 (11.3)	1,600 (11)	1,535 (10.6)	1,490 (10.3)	1,355 (9.3)
Temperatura rango B <sup>2</sup>	Esfuerzo característico de adherencia en concreto fisurado	$\tau_{k,cr}$	psi (MPa)	825 (5.7)	875 (6.0)	865 (6.0)	910 (6.3)	890 (6.1)	885 (6.1)	840 (5.8)
	Esfuerzo característico de adherencia en concreto no fisurado	$\tau_{k,uncr}$	psi (MPa)	1,755 (12.1)	1,710 (11.8)	1,645 (11.3)	1,600 (11.0)	1,535 (10.6)	1,490 (10.3)	1,355 (9.3)
Temperatura rango C <sup>2</sup>	Esfuerzo característico de adherencia en concreto fisurado	$\tau_{k,cr}$	psi (MPa)	675 (4.7)	715 (4.9)	710 (4.9)	745 (5.1)	730 (5.0)	730 (5.0)	690 (4.8)
	Esfuerzo característico de adherencia en concreto no fisurado	$\tau_{k,uncr}$	psi (MPa)	1,440 (9.9)	1,405 (9.7)	1,350 (9.3)	1,310 (9.0)	1,260 (8.7)	1,220 (8.4)	1,110 (7.7)
Condiciones de instalación permisibles	Agujero lleno de agua 	Categoría de Anclaje	-	3						
		$\phi_{wf}$	-	0.45						
Reducción por tensión sísmica	Perforado con rotomartillo 	$\alpha_{N,seis}$	-	0.88	0.99	0.99	1.0	1.0	0.95	0.99

Para SI: 1 pulgada = 25.4 mm, 1 lbf = 4.448 N, 1 psi = 0.006897 MPa.

Para unidades libra-pulgada: 1 mm = 0.03937 pulgadas, 1 N = 0.2248 lbf, 1 MPa = 145.0 psi

<sup>1</sup> Los valores del esfuerzo de adherencia corresponden a la resistencia del concreto a la compresión  $f'_c = 2,500$  psi (17.2 MPa). Para la resistencia a la compresión del concreto,  $f'_c$ , entre 2,500 psi (17.2 MPa) y 8,000 psi (55.2 MPa), el esfuerzo característico de adherencia tabulado puede incrementar por el factor de  $(f'_c / 2,500)^{0.1}$  [Para SI:  $(f'_c / 17.2)^{0.1}$ ]. Ver la Sección 4.1.4 de este reporte para la determinación del esfuerzo de adherencia.

<sup>2</sup> Temperatura rango A: Temperatura máxima a corto plazo= 130°F (55°C), Temperatura máxima a largo plazo= 110°F (43°C).

Temperatura rango B: Temperatura máxima a corto plazo= 176°F (80°C), Temperatura máxima a largo plazo= 110°F (43°C).

Temperatura rango C: Temperatura máxima a corto plazo= 248°F (120°C), Temperatura máxima a largo plazo= 162°F (72°C).

Las temperaturas elevadas a corto plazo del concreto son aquellas que ocurren a intervalos cortos, por ejemplo, como resultado del ciclo diario. Las temperaturas a largo plazo son constantes a lo largo de periodos significativos de tiempo.



Varillas Roscadas Métricas y Barras de Refuerzo Métricas EU

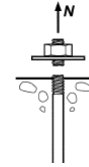

Resistencia del Acero

TABLA 17—INFORMACIÓN DEL DISEÑO DEL ACERO PARA VARILLAS ROSCADAS MÉTRICAS Y BARRAS DE REFUERZO MÉTRICAS EU

INFORMACIÓN DE DISEÑO		Símbolo	Unidades	Diámetro Nominal de la Varilla (mm) <sup>1</sup>							
				10	12	16	20	24	27	30	
Diámetro Exterior de la Varilla		<i>d</i>	mm (pulg.)	10 (0.39)	12 (0.47)	16 (0.63)	20 (0.79)	24 (0.94)	27 (1.06)	30 (1.18)	
Área efectiva de la sección transversal de la varilla		<i>A<sub>se</sub></i>	mm <sup>2</sup> (pulg. <sup>2</sup> )	58.0 (0.090)	84.3 (0.131)	157 (0.243)	245 (0.380)	353 (0.547)	459 (0.711)	561 (0.870)	
ISO 898-1 Clase 5.8	Resistencia nominal que se rige por la Resistencia del Acero	<i>N<sub>sa</sub></i>	kN (lb)	29.0 (6,519)	42.0 (9,476)	78.5 (17,647)	122.5 (27,539)	176.5 (39,679)	229.5 (51,594)	280.5 (63,059)	
		<i>V<sub>sa</sub></i>	kN (lb)	14.5 (3,260)	25.5 (5,685)	47.0 (10,588)	73.5 (16,523)	106.0 (23,807)	137.5 (30,956)	168.5 (37,835)	
	Reducción para el cortante sísmico	<i>α<sub>V,seis</sub></i>	-	1.00							
	Factor de reducción de resistencia para la tensión <sup>2</sup>	<i>φ</i>	-	0.65							
	Factor de reducción de resistencia para el cortante <sup>2</sup>	<i>φ</i>	-	0.60							
ISO 898-1 Clase 8.8	Resistencia nominal que se rige por la Resistencia del Acero	<i>N<sub>sa</sub></i>	kN (lb)	46.5 (10,431)	67.5 (15,161)	125.5 (28,236)	196.0 (44,063)	282.5 (63,486)	367.0 (82,550)	449.0 (100,894)	
		<i>V<sub>sa</sub></i>	kN (lb)	23.0 (5,216)	40.5 (9,097)	75.5 (16,942)	117.5 (26,438)	169.5 (38,092)	220.5 (49,530)	269.5 (60,537)	
	Reducción para el cortante sísmico	<i>α<sub>V,seis</sub></i>	-	1.00							
	Factor de reducción de resistencia para la tensión <sup>2</sup>	<i>φ</i>	-	0.65							
	Factor de reducción de resistencia para el cortante <sup>2</sup>	<i>φ</i>	-	0.60							
ISO 3506-1 Clase A4 Inoxidable <sup>3</sup>	Resistencia nominal que se rige por la Resistencia del Acero	<i>N<sub>sa</sub></i>	kN (lb)	40.6 (9,127)	59.0 (13,266)	109.9 (24,706)	171.5 (38,555)	247.1 (55,550)	183.1 (41,172)	223.8 (50,321)	
		<i>V<sub>sa</sub></i>	kN (lb)	20.3 (4,564)	35.4 (7,960)	65.9 (14,824)	102.9 (23,133)	148.3 (33,330)	109.9 (24,703)	134.3 (30,192)	
	Reducción para el cortante sísmico	<i>α<sub>V,seis</sub></i>	-	0.80							
	Factor de reducción de resistencia para la tensión <sup>2</sup>	<i>φ</i>	-	0.65							
	Factor de reducción de resistencia para el cortante <sup>2</sup>	<i>φ</i>	-	0.60							
INFORMACIÓN DE DISEÑO		Símbolo	Unidades	Tamaño de la barra de refuerzo							
				10	12	14	16	20	25	28	32
Diámetro nominal de la barra		<i>d</i>	mm (pulg.)	10.0 (0.394)	12.0 (0.472)	14.0 (0.551)	16.0 (0.630)	20.0 (0.787)	25.0 (0.984)	28.0 (1.102)	32.0 (1.260)
Área efectiva de la sección transversal de la barra		<i>A<sub>se</sub></i>	mm <sup>2</sup> (pulg. <sup>2</sup> )	78.5 (0.122)	113.1 (0.175)	153.9 (0.239)	201.1 (0.312)	314.2 (0.487)	490.9 (0.761)	615.8 (0.954)	804.2 (1.247)
DIN 488 BSt 550/500	Resistencia nominal que se rige por la Resistencia del Acero	<i>N<sub>sa</sub></i>	kN (lb)	43.0 (9,711)	62.0 (13,984)	84.5 (19,034)	110.5 (24,860)	173.0 (38,844)	270.0 (60,694)	338.5 (76,135)	442.5 (99,441)
		<i>V<sub>sa</sub></i>	kN (lb)	26.0 (5,827)	37.5 (8,390)	51.0 (11,420)	66.5 (14,916)	103.0 (23,307)	162.0 (36,416)	203.0 (45,681)	265.5 (59,665)
	Reducción para el cortante sísmico	<i>α<sub>V,seis</sub></i>	-	0.70							
	Factor de reducción de resistencia para la tensión <sup>2</sup>	<i>φ</i>	-	0.65							
	Factor de reducción de resistencia para el cortante <sup>2</sup>	<i>φ</i>	-	0.60							

Para SI: 1 pulgada ≅ 25.4 mm, 1 lbf = 4.448 N, 1 psi = 0.006897 MPa.

Para unidades libra-pulgada: 1 mm = 0.03937 pulgadas, 1 N = 0.2248 lbf, 1 MPa = 145.0 psi

<sup>1</sup> Los valores proporcionados para los tipos de materiales de la varilla común se basan en resistencias especificadas y calculadas de acuerdo con ACI 318-19 Ec. (17.6.1.2) y Ec. (17.7.1.2b), ACI 318-14 Ec. (17.4.1.2) y Ec. (17.5.1.2b) o ACI 318-11 Ec. (D-2) y Ec. (D-29). Las tuercas y arandelas deben ser apropiadas para la varilla.

<sup>2</sup> El factor de reducción de resistencia se aplica cuando se usan las cargas combinadas del IBC o ACI 318 y se cumplen los requisitos de ACI 318-19 17.5.3, ACI 318-14 17.3.3 o ACI 318-11 D.4.3, según se aplique. Si se usan las cargas combinadas del Apéndice C de ACI 318-11, el valor apropiado del factor de reducción de resistencia debe determinarse de acuerdo con ACI 318-11 D.4.4.

<sup>3</sup> A4-70 Inoxidable (M8- M24); A4-502 Inoxidable (M27- M30)



Varillas Roscadas Métricas y Barras de Refuerzo Métricas EU

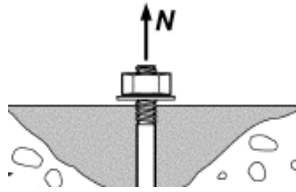

Resistencia al Arrancamiento del Concreto

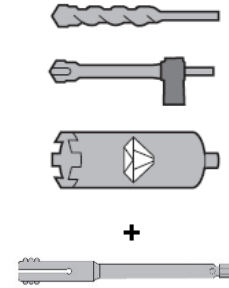

Broca de Carburo o Broca Hueca de Carburo Hilti o Broca Corona de Diamante con Herramienta de Desbaste

**TABLA 18—INFORMACIÓN DE DISEÑO DEL ARRANCAMIENTO DEL CONCRETO PARA VARILLAS ROSCADAS MÉTRICAS Y BARRAS DE REFUERZO MÉTRICAS EU EN AGUJEROS PERFORADOS CON ROTO MARTILLO Y BROCA DE CARBURO (O BROCA HUECA DE CARBURO HILTI) O PERFORADO CON BROCA CORONA DE DIAMANTE Y DESBASTADO CON HERRAMIENTA DE DESBASTE HILTI<sup>1</sup>**

INFORMACIÓN DE DISEÑO	Símbolo	Unidades	Diámetro Nominal de la Varilla (mm)							
			10	12	16	20	24	27	30	
Empotramiento mínimo	$h_{ef,min}$	mm (pulg.)	60 (2.4)	70 (2.8)	80 (3.1)	90 (3.5)	96 (3.8)	108 (4.3)	120 (4.7)	
Empotramiento máximo	$h_{ef,max}$	mm (pulg.)	200 (7.9)	240 (9.4)	320 (12.6)	400 (15.7)	480 (18.9)	540 (21.3)	600 (23.6)	
Separación mínima entre anclajes <sup>3</sup>	$s_{min}$	mm (pulg.)	50 (2.0)	60 (2.4)	80 (3.2)	100 (3.9)	120 (4.7)	135 (5.3)	150 (5.9)	
Distancia mínima al borde <sup>3</sup>	$c_{min}$	-	5d; o ver Sección 4.1.9.2 de este reporte para el diseño con distancias mínimas al borde reducidas							
Espesor mínimo del concreto	$h_{min}$	mm (pulg.)	$h_{ef} + 30$ $(h_{ef} + 1\frac{1}{4})$	$h_{ef} + 2d_o^{(4)}$						
INFORMACIÓN DE DISEÑO	Símbolo	Unidades	Tamaño de la barra de refuerzo							
			10	12	14	16	20	25	28	32
Empotramiento mínimo	$h_{ef,min}$	mm (pulg.)	60 (2.4)	70 (2.8)	75 (3.0)	80 (3.1)	90 (3.5)	100 (3.9)	112 (4.4)	128 (5.0)
Empotramiento máximo	$h_{ef,max}$	mm (pulg.)	200 (7.9)	240 (9.4)	280 (11.0)	320 (12.6)	400 (15.7)	500 (19.7)	560 (22.0)	640 (25.2)
Separación mínima entre anclajes <sup>3</sup>	$s_{min}$	mm (pulg.)	50 (2.0)	60 (2.4)	80 (3.2)	100 (3.9)	120 (4.7)	135 (5.3)	140 (5.5)	160 (6.3)
Distancia mínima al borde <sup>3</sup>	$c_{min}$	-	5d; o ver Sección 4.1.9 de este reporte para el diseño con distancias mínimas al borde reducidas							
Espesor mínimo del concreto	$h_{min}$	mm (pulg.)	$h_{ef} + 30$ $(h_{ef} + 1\frac{1}{4})$	$h_{ef} + 2d_o^{(4)}$						
Distancia crítica al borde – hendimiento (para concreto no fisurado)	$c_{ac}$	-	Ver Sección 4.1.10.2 de este reporte.							
Factor de efectividad para concreto fisurado	$k_{c,cr}$	SI (pulg-lb)	7.1 (17)							
Factor de efectividad para concreto no fisurado	$k_{c,uncr}$	SI (pulg-lb)	10 (24)							
Factor de reducción de resistencia para la tensión, modos de falla del concreto, Condición B (sin reforzamiento suplementario) <sup>2</sup>	$\phi$	-	0.65							
Factor de reducción de resistencia para el cortante, modos de falla del concreto, Condición B (sin reforzamiento suplementario) <sup>2</sup>	$\phi$	-	0.70							

Para SI: 1 pulgada ≅ 25.4 mm, 1 lbf = 4.448 N, 1 psi = 0.006897 MPa.  
 Para unidades libra-pulgada: 1 mm = 0.03937 pulgadas, 1 N = 0.2248 lbf, 1 MPa = 145.0 psi

<sup>1</sup> Información de ajuste adicional se describe en la Figura 6, Instrucciones de instalación impresas del fabricante (MPII).  
<sup>2</sup> El factor de reducción de resistencia se aplica cuando se usan las cargas combinadas del IBC o ACI 318 y se cumplen los requisitos de ACI 318-19 17.5.3, ACI 318-14 17.3.3 o ACI 318-11 D.4.3, según se aplique. Si se usan las cargas combinadas del Apéndice C de ACI 318-11, el valor apropiado del factor de reducción de resistencia debe determinarse de acuerdo con ACI 318-11 D.4.4.  
<sup>3</sup> Para instalaciones con distancia al borde de 1<sup>3</sup>/<sub>4</sub> pulgada, consulte la Sección 4.1.9.2 para los requerimientos de espaciado y torque máximo.  
<sup>4</sup>  $d_o$  = diámetro del agujero.

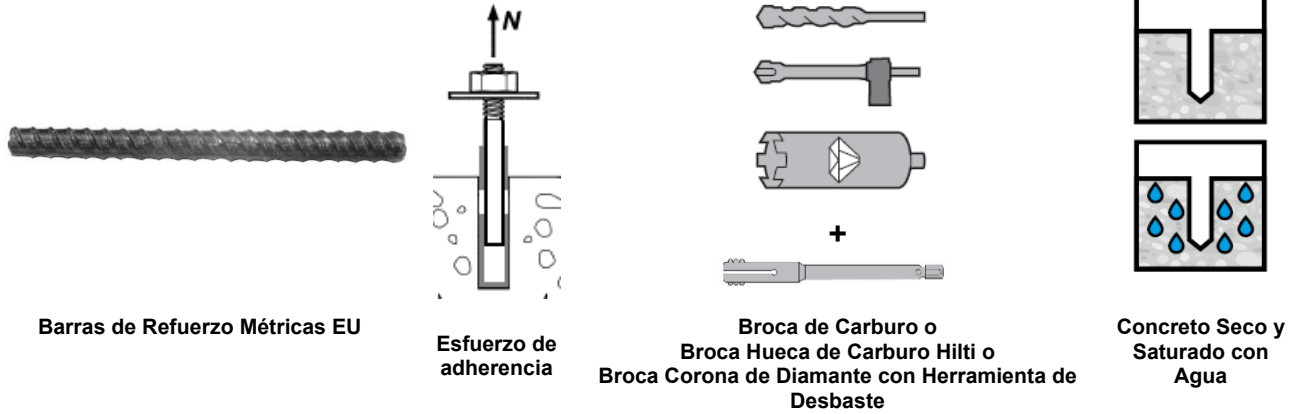

Barras de Refuerzo Métricas EU

Esfuerzo de adherencia

Broca de Carburo o Broca Hueca de Carburo Hilti o Broca Corona de Diamante con Herramienta de Desbaste

Concreto Seco y Saturado con Agua

**TABLA 19—INFORMACIÓN DE DISEÑO DEL ESFUERZO DE ADHERENCIA PARA BARRAS DE REFUERZO MÉTRICAS EU EN AGUJEROS PERFORADOS CON ROTO MARTILLO Y BROCA DE CARBURO (O BROCA HUECA DE CARBURO HILTI) O PERFORADO CON BROCA CORONA DE DIAMANTE Y DESBASTADO CON HERRAMIENTA DE DESBASTE HILTI<sup>1</sup>**

INFORMACIÓN DE DISEÑO		Símbolo	Unidades	Tamaño de la barra de refuerzo							
				10	12	14	16	20	25	28	32
Empotramiento mínimo		$h_{ef,min}$	mm (pulg.)	60 (2.4)	70 (2.8)	75 (3.0)	80 (3.1)	90 (3.5)	100 (3.9)	112 (4.4)	128 (5.0)
Empotramiento máximo		$h_{ef,max}$	mm (pulg.)	200 (7.9)	240 (9.4)	280 (11.0)	320 (12.6)	400 (15.7)	500 (19.7)	560 (22.0)	640 (25.2)
Temperatura rango A <sup>2</sup>	Esfuerzo característico de adherencia en concreto fisurado	$\tau_{k,cr}$	MPa (psi)	7.4 (1,075)	7.5 (1,080)	7.5 (1,085)	7.5 (1,090)	7.5 (1,095)	5.8 (840)	5.8 (845)	5.9 (850)
	Esfuerzo característico de adherencia en concreto no fisurado	$\tau_{k,un-cr}$	MPa (psi)	10.8 (1,560)	10.8 (1,560)	10.8 (1,560)	10.8 (1,560)	10.8 (1,560)	10.8 (1,560)	10.8 (1,560)	10.8 (1,560)
Temperatura rango B <sup>2</sup>	Esfuerzo característico de adherencia en concreto fisurado	$\tau_{k,cr}$	MPa (psi)	7.4 (1,075)	7.5 (1,080)	7.5 (1,085)	7.5 (1,090)	7.5 (1,095)	5.8 (840)	5.8 (845)	5.9 (850)
	Esfuerzo característico de adherencia en concreto no fisurado	$\tau_{k,un-cr}$	MPa (psi)	10.8 (1,560)	10.8 (1,560)	10.8 (1,560)	10.8 (1,560)	10.8 (1,560)	10.8 (1,560)	10.8 (1,560)	10.8 (1,560)
Temperatura rango C <sup>2</sup>	Esfuerzo característico de adherencia en concreto fisurado	$\tau_{k,cr}$	MPa (psi)	6.1 (885)	6.1 (885)	6.1 (890)	6.2 (895)	6.2 (900)	4.8 (690)	4.8 (695)	4.8 (700)
	Esfuerzo característico de adherencia en concreto no fisurado	$\tau_{k,un-cr}$	MPa (psi)	8.8 (1,280)	8.8 (1,280)	8.8 (1,280)	8.8 (1,280)	8.8 (1,280)	8.8 (1,280)	8.8 (1,280)	8.8 (1,280)
Condiciones de instalación permisibles	Concreto Seco y Saturado con Agua 	Categoría de Anclaje	-	1							
		$\phi_b, \phi_{vs}$	-	0.65							
Reducción por tensión sísmica	Perforado con rotomartillo 	$\alpha_{N,seis}$	-	0.80					0.85	0.90	1.00
	Perforado con diamante + desbaste 	$\alpha_{N,seis}$	-	N/A		0.71	0.77	0.86	0.78	0.86	

Para SI: 1 pulgada  $\approx$  25.4 mm, 1 lbf = 4.448 N, 1 psi = 0.006897 MPa.  
 Para unidades libra-pulgada: 1 mm = 0.03937 pulgadas, 1 N = 0.2248 lbf, 1 MPa = 145.0 psi

<sup>1</sup> Los valores del esfuerzo de adherencia corresponden a la resistencia del concreto a la compresión  $f'_c = 2,500$  psi (17.2 MPa). Para la resistencia a la compresión del concreto,  $f_{ci}$ , entre 2,500 psi (17.2 MPa) y 8,000 psi (55.2 MPa), el esfuerzo característico de adherencia tabulado puede incrementarse por el factor de  $(f_{ci} / 2,500)^{0.1}$  [Para SI:  $(f_{ci} / 17.2)^{0.1}$ ]. Ver la Sección 4.1.4 de este reporte para la determinación del esfuerzo de adherencia.

<sup>2</sup> Temperatura rango A: Temperatura máxima a corto plazo = 130°F (55°C), Temperatura máxima a largo plazo = 110°F (43°C).  
 Temperatura rango B: Temperatura máxima a corto plazo = 176°F (80°C), Temperatura máxima a largo plazo = 110°F (43°C).  
 Temperatura rango C: Temperatura máxima a corto plazo = 248°F (120°C), Temperatura máxima a largo plazo = 162°F (72°C).  
 Las temperaturas elevadas a corto plazo del concreto son aquellas que ocurren a intervalos cortos, por ejemplo, como resultado del ciclo diario. Las temperaturas a largo plazo son constantes a lo largo de periodos significativos de tiempo.

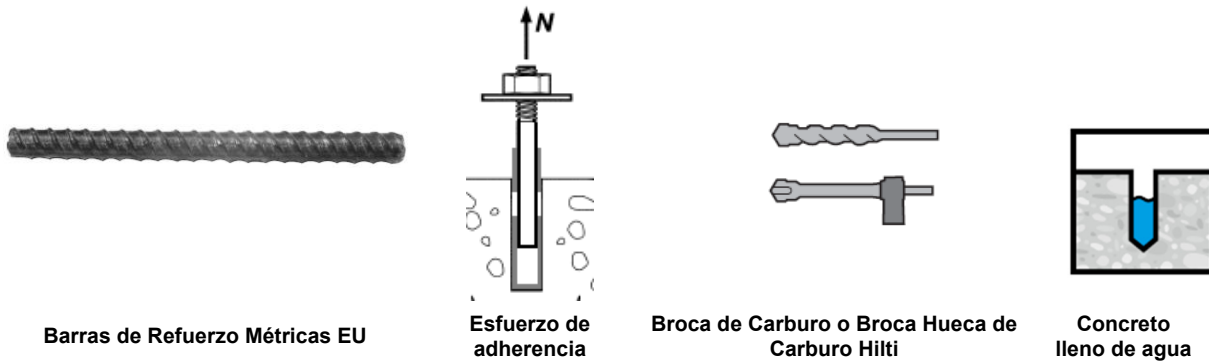

**TABLA 20—INFORMACIÓN DE DISEÑO DEL ESFUERZO DE ADHERENCIA PARA BARRAS DE REFUERZO MÉTRICAS FRACCIONALES EN AGUJEROS PERFORADOS CON ROTO MARTILLO Y BROCA DE CARBURO (O BROCA HUECA DE CARBURO HILTI)**

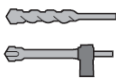
INFORMACIÓN DE DISEÑO		Símbolo	Unidades	Tamaño nominal de la barra de refuerzo							
				10	12	14	16	20	25	28	32
Empotramiento mínimo		$h_{ef,min}$	pulg. (mm)	2 <sup>3</sup> / <sub>8</sub> (60)	2 <sup>3</sup> / <sub>4</sub> (70)	3 <sup>1</sup> / <sub>8</sub> (79)	3 <sup>1</sup> / <sub>2</sub> (89)	3 <sup>1</sup> / <sub>2</sub> (89)	4 (102)	4 <sup>1</sup> / <sub>2</sub> (114)	5 (127)
Empotramiento máximo		$h_{ef,max}$	pulg. (mm)	7 <sup>1</sup> / <sub>2</sub> (191)	10 (254)	12 <sup>1</sup> / <sub>2</sub> (318)	15 (381)	17 <sup>1</sup> / <sub>2</sub> (445)	20 (508)	22 <sup>1</sup> / <sub>2</sub> (572)	25 (635)
Temperatura rango A <sup>2</sup>	Esfuerzo característico de adherencia en concreto fisurado	$\tau_{k,cr}$	MPa (psi)	(7.2) 1,050	(7.2) 1,050	(7.2) 1,050	(7.4) 1,070	(7.4) 1,070	(5.7) 820	(5.7) 820	(5.7) 830
	Esfuerzo característico de adherencia en concreto no fisurado	$\tau_{k,un-cr}$	MPa (psi)	(10.5) 1,520	(10.5) 1,520	(10.5) 1,520	(10.5) 1,520	(10.5) 1,520	(10.5) 1,520	(10.5) 1,520	(10.5) 1,520
Temperatura rango B <sup>2</sup>	Esfuerzo característico de adherencia en concreto fisurado	$\tau_{k,cr}$	MPa (psi)	(7.2) 1,050	(7.2) 1,050	(7.2) 1,050	(7.4) 1,070	(7.4) 1,070	(5.7) 820	(5.7) 820	(5.7) 830
	Esfuerzo característico de adherencia en concreto no fisurado	$\tau_{k,un-cr}$	MPa (psi)	(10.5) 1,520	(10.5) 1,520	(10.5) 1,520	(10.5) 1,520	(10.5) 1,520	(10.5) 1,520	(10.5) 1,520	(10.5) 1,520
Temperatura rango C <sup>2</sup>	Esfuerzo característico de adherencia en concreto fisurado	$\tau_{k,cr}$	MPa (psi)	(6.0) 865	(6.0) 865	(6.0) 865	(6.1) 875	(6.1) 875	(4.7) 680	(4.7) 680	(4.7) 680
	Esfuerzo característico de adherencia en concreto no fisurado	$\tau_{k,un-cr}$	MPa (psi)	(8.6) 1,250	(8.6) 1,250	(8.6) 1,250	(8.6) 1,250	(8.6) 1,250	(8.6) 1,250	(8.6) 1,250	(8.6) 1,250
Condiciones de instalación permisibles	Agujero lleno de agua 	Categoría de Anclaje	-	3							
		$\phi_{mf}$	-	0.45							
Reducción por tensión sísmica	Perforado con rotomartillo 	$\alpha_{N,seis}$	-	0.80			0.85	0.90	0.95	1.0	

Parar SI: 1 pulgada  $\equiv$  25.4 mm, 1 lbf = 4.448 N, 1 psi = 0.006897 MPa.  
 Para unidades libra-pulgada: 1 mm = 0.03937 pulgadas, 1 N = 0.2248 lbf, 1 MPa = 145.0 psi

<sup>1</sup> Los valores del esfuerzo de adherencia corresponden a la resistencia del concreto a la compresión  $f'_c = 2,500$  psi (17.2 MPa). Para la resistencia a la compresión del concreto,  $f'_c$ , entre 2,500 psi (17.2 MPa) y 8,000 psi (55.2 MPa), el esfuerzo característico de adherencia tabulado puede incrementar por el factor de  $(f'_c / 2,500)^{0.1}$  [Para SI:  $(f'_c / 17.2)^{0.1}$ ]. Ver la Sección 4.1.4 de este reporte para la determinación del esfuerzo de adherencia.

<sup>2</sup> Temperatura rango A: Temperatura máxima a corto plazo = 130°F (55°C), Temperatura máxima a largo plazo = 110°F (43°C).

Temperatura rango B: Temperatura máxima a corto plazo = 176°F (80°C), Temperatura máxima a largo plazo = 110°F (43°C).

Temperatura rango C: Temperatura máxima a corto plazo = 248°F (120°C), Temperatura máxima a largo plazo = 162°F (72°C).

Las temperaturas elevadas a corto plazo del concreto son aquellas que ocurren a intervalos cortos, por ejemplo, como resultado del ciclo diurno. Las temperaturas a largo plazo son constantes a lo largo de periodos significativos de tiempo.

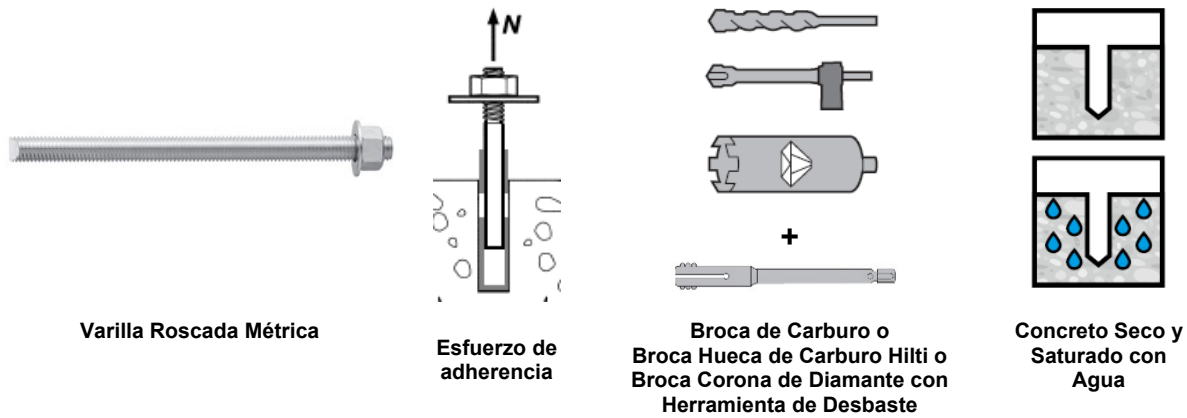

**TABLA 21—INFORMACIÓN DE DISEÑO DEL ESFUERZO DE ADHERENCIA PARA VARILLA ROSCADA MÉTRICA EN AGUJEROS PERFORADOS CON ROTO MARTILLO Y BROCA DE CARBURO (O BROCA HUECA DE CARBURO HILTI) O PERFORADO CON BROCA CORONA DE DIAMANTE Y DESBASTADO CON HERRAMIENTA DE DESBASTE HILTI<sup>1</sup>**

INFORMACIÓN DE DISEÑO		Símbolo	Unidades	Diámetro nominal de la varilla (mm)						
				10	12	16	20	24	27	30
Empotramiento mínimo		$h_{ef,min}$	mm (pulg.)	60 (2.4)	70 (2.8)	80 (3.1)	90 (3.5)	96 (3.8)	108 (4.3)	120 (4.7)
Empotramiento máximo		$h_{ef,max}$	mm (pulg.)	200 (7.9)	240 (9.4)	320 (12.6)	400 (15.7)	480 (18.9)	540 (21.3)	600 (23.6)
Temperatura rango A <sup>2</sup>	Esfuerzo característico de adherencia en concreto fisurado	$\tau_{k,cr}$	MPa (psi)	7.3 (1,055)	7.6 (1,105)	8.1 (1,170)	8.8 (1,270)	9.0 (1,305)	9.2 (1,340)	9.4 (1,365)
	Esfuerzo característico de adherencia en concreto no fisurado	$\tau_{k,un-cr}$	MPa (psi)	15.3 (2,220)	15.3 (2,220)	15.3 (2,220)	15.3 (2,220)	15.3 (2,220)	15.3 (2,220)	15.3 (2,220)
Temperatura rango B <sup>2</sup>	Esfuerzo característico de adherencia en concreto fisurado	$\tau_{k,cr}$	MPa (psi)	7.3 (1,055)	7.6 (1,105)	8.1 (1,170)	8.8 (1,270)	9.0 (1,305)	9.2 (1,340)	9.4 (1,365)
	Esfuerzo característico de adherencia en concreto no fisurado	$\tau_{k,un-cr}$	MPa (psi)	15.3 (2,220)	15.3 (2,220)	15.3 (2,220)	15.3 (2,220)	15.3 (2,220)	15.3 (2,220)	15.3 (2,220)
Temperatura rango C <sup>2</sup>	Esfuerzo característico de adherencia en concreto fisurado	$\tau_{k,cr}$	MPa (psi)	6.0 (865)	6.3 (905)	6.6 (960)	7.2 (1,040)	7.4 (1,070)	7.6 (1,095)	7.7 (1,120)
	Esfuerzo característico de adherencia en concreto no fisurado	$\tau_{k,un-cr}$	MPa (psi)	12.6 (1,820)	12.6 (1,820)	12.6 (1,820)	12.6 (1,820)	12.6 (1,820)	12.6 (1,820)	12.6 (1,820)
Condiciones de instalación permisibles	Concreto Seco y Saturado con Agua 	Categoría de Anclaje	-	1						
		$\phi_d, \phi_{ws}$	-	0.65						
Reducción por tensión sísmica	Perforado con rotomartillo	$\alpha_{N,seis}$	-	0.88	0.88	0.99	1.0	0.95	0.95	0.95
	Perforado con diamante + desbaste	$\alpha_{N,seis}$	-	N/A		0.88	0.96	0.96	0.82	0.82

Para SI: 1 pulgada  $\equiv$  25.4 mm, 1 lbf = 4.448 N, 1 psi = 0.006897 MPa.  
 Para unidades libra-pulgada: 1 mm = 0.03937 pulgadas, 1 N = 0.2248 lbf, 1 MPa = 145.0 psi

<sup>1</sup> Los valores del esfuerzo de adherencia corresponden a la resistencia del concreto a la compresión  $f'_c = 2,500$  psi (17.2 MPa). Para la resistencia a la compresión del concreto,  $f'_c$ , entre 2,500 psi (17.2 MPa) y 8,000 psi (55.2 MPa), el esfuerzo característico de adherencia tabulado puede incrementar por el factor de  $(f'_c / 2,500)^{0.1}$  [Para SI:  $(f'_c / 17.2)^{0.1}$ ]. Ver la Sección 4.1.4 de este reporte para la determinación del esfuerzo de adherencia.

<sup>2</sup> Temperatura rango A: Temperatura máxima a corto plazo = 130°F (55°C), Temperatura máxima a largo plazo = 110°F (43°C).  
 Temperatura rango B: Temperatura máxima a corto plazo = 176°F (80°C), Temperatura máxima a largo plazo = 110°F (43°C).  
 Temperatura rango C: Temperatura máxima a corto plazo = 248°F (120°C), Temperatura máxima a largo plazo = 162°F (72°C).

Las temperaturas elevadas a corto plazo del concreto son aquellas que ocurren a intervalos cortos, por ejemplo, como resultado del ciclo diurno. Las



temperaturas a largo plazo son constantes a lo largo de periodos significativos de tiempo.

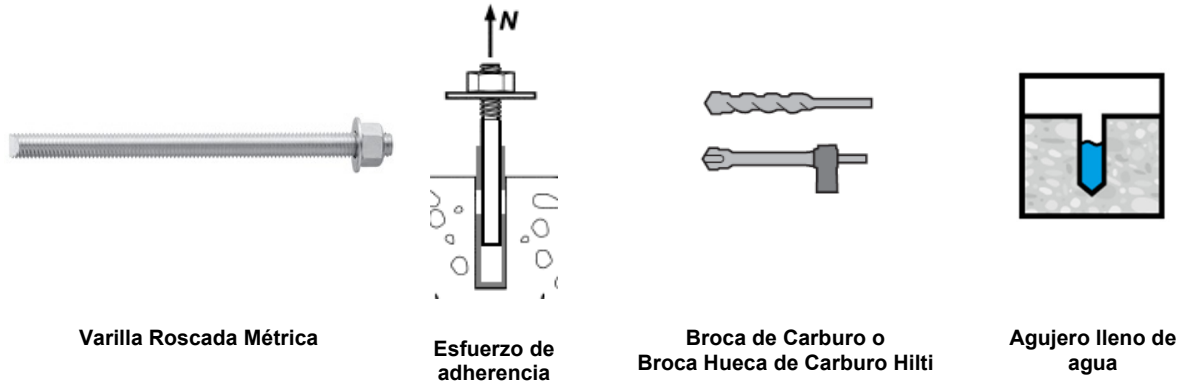

Varilla Roscada Métrica

Esfuerzo de adherencia

Broca de Carburo o Broca Hueca de Carburo Hilti

Agujero lleno de agua

TABLA 22—INFORMACIÓN DE DISEÑO DEL ESFUERZO DE ADHERENCIA PARA VARILLA ROSCADA MÉTRICA EN AGUJEROS PERFORADOS CON ROTO MARTILLO Y BROCA DE CARBURO (O BROCA HUECA DE CARBURO HILTI)

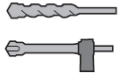
INFORMACIÓN DE DISEÑO		Símbolo	Unidades	Diámetro nominal de la varilla (mm)						
				10	12	16	20	24	27	30
Empotramiento mínimo		$h_{ef,min}$	mm (pulg.)	60 (2.4)	70 (2.8)	80 (3.1)	90 (3.5)	96 (3.8)	108 (4.3)	120 (4.7)
Empotramiento máximo		$h_{ef,max}$	mm (pulg.)	200 (7.9)	240 (9.4)	320 (12.6)	400 (15.7)	480 (18.9)	540 (21.3)	600 (23.6)
Temperatura rango A <sup>2</sup>	Esfuerzo característico de adherencia en concreto fisurado	$\tau_{k,cr}$	MPa (psi)	5.8 (835)	5.9 (850)	6.0 (865)	6.2 (900)	6.1 (885)	6.0 (870)	5.9 (860)
	Esfuerzo característico de adherencia en concreto no fisurado	$\tau_{k,uncr}$	MPa (psi)	12.1 (1755)	11.8 (1710)	11.3 (1645)	10.9 (1580)	10.4 (1510)	10.0 (1445)	9.7 (1400)
Temperatura rango B <sup>2</sup>	Esfuerzo característico de adherencia en concreto fisurado	$\tau_{k,cr}$	MPa (psi)	5.8 (835)	5.9 (850)	6.0 (865)	6.2 (900)	6.1 (885)	6.0 (870)	5.9 (860)
	Esfuerzo característico de adherencia en concreto no fisurado	$\tau_{k,uncr}$	MPa (psi)	12.1 (1755)	11.8 (1710)	11.3 (1645)	10.9 (1580)	10.4 (1510)	10.0 (1445)	9.7 (1400)
Temperatura rango C <sup>2</sup>	Esfuerzo característico de adherencia en concreto fisurado	$\tau_{k,cr}$	MPa (psi)	4.7 (685)	4.8 (700)	4.9 (710)	5.1 (740)	5.0 (725)	4.9 (715)	4.9 (705)
	Esfuerzo característico de adherencia en concreto no fisurado	$\tau_{k,uncr}$	MPa (psi)	9.9 (1440)	9.7 (1405)	9.3 (1350)	8.9 (1295)	8.5 (1240)	8.2 (1185)	7.9 (1150)
Condiciones de instalación permisibles	Agujero lleno de agua 	Categoría de Anclaje	-	3						
		$\phi_{wf}$	-	0.45						
Reducción por tensión sísmica	Perforado con rotomartillo 	$\alpha_{N,seis}$	-	0.88	0.88	0.99	1.0	0.95	0.95	0.95

Para SI: 1 pulgada  $\equiv$  25.4 mm, 1 lbf = 4.448 N, 1 psi = 0.006897 MPa.  
 Para unidades libra-pulgada: 1 mm = 0.03937 pulgadas, 1 N = 0.2248 lbf, 1 MPa = 145.0 psi

<sup>1</sup> Los valores del esfuerzo de adherencia corresponden a la resistencia del concreto a la compresión  $f_c = 2,500$  psi (17.2 MPa). Para la resistencia a la compresión del concreto,  $f_c$ , entre 2,500 psi (17.2 MPa) y 8,000 psi (55.2 MPa), el esfuerzo característico de adherencia tabulado puede incrementarse por el factor de  $(f_c / 2,500)^{0.1}$  [Para SI:  $(f_c / 17.2)^{0.1}$ ]. Ver la Sección 4.1.4 de este reporte para la determinación del esfuerzo de adherencia.

<sup>2</sup> Temperatura rango A: Temperatura máxima a corto plazo= 130°F (55°C), Temperatura máxima a largo plazo= 110°F (43°C).  
 Temperatura rango B: Temperatura máxima a corto plazo= 176°F (80°C), Temperatura máxima a largo plazo= 110°F (43°C).  
 Temperatura rango C: Temperatura máxima a corto plazo= 248°F (120°C), Temperatura máxima a largo plazo= 162°F (72°C).  
 Las temperaturas elevadas a corto plazo del concreto son aquellas que ocurren a intervalos cortos, por ejemplo, como resultado del ciclo diario. Las temperaturas a largo plazo son constantes a lo largo de periodos significativos de tiempo.



Barras de Refuerzo Canadienses

Resistencia del Acero

TABLA 23—INFORMACIÓN DEL DISEÑO DEL ACERO PARA BARRAS DE REFUERZO MÉTRICAS CANADIENSES

INFORMACIÓN DE DISEÑO			Símbolo	Unidades	Tamaño de la barra					
					10 M	15 M	20 M	25 M	30 M	
Diámetro nominal de la barra			$d$	mm (pulg.)	11.3 (0.445)	16.0 (0.630)	19.5 (0.768)	25.2 (0.992)	29.9 (1.177)	
Área efectiva de la sección transversal de la barra			$A_{se}$	mm <sup>2</sup> (pulg. <sup>2</sup> )	100.3 (0.155)	201.1 (0.312)	298.6 (0.463)	498.8 (0.773)	702.2 (1.088)	
CSA G30	Resistencia nominal que se rige por la Resistencia del Acero	$N_{sa}$	kN (lb)	54.0 (12,175)	108.5 (24,408)	161.5 (36,255)	270.0 (60,548)	380.0 (85,239)		
		$V_{sa}$	kN (lb)	32.5 (7,305)	65.0 (14,645)	97.0 (21,753)	161.5 (36,329)	227.5 (51,144)		
	Reducción para el cortante sísmico			$\alpha_{V,seis}$	-	0.70				
	Factor de reducción de resistencia para la tensión <sup>1</sup>			$\phi$	-	0.65				
	Factor de reducción de resistencia para el cortante <sup>1</sup>			$\phi$	-	0.60				

Para SI: 1 pulgada ≅ 25.4 mm, 1 lbf = 4.448 N, 1 psi = 0.006897 MPa.

Para unidades libra-pulgada: 1 mm = 0.03937 pulgadas, 1 N = 0.2248 lbf, 1 MPa = 145.0 psi

<sup>1</sup> Para uso con las cargas combinadas de ACI 318-19 y ACI 318-14 5.3 o ACI 318-11 9.2, como se establece en ACI 318-19 17.5.3, ACI 318-14 17.3.3 o ACI 318-11 D.4.3. Los valores corresponden a un elemento frágil del acero.

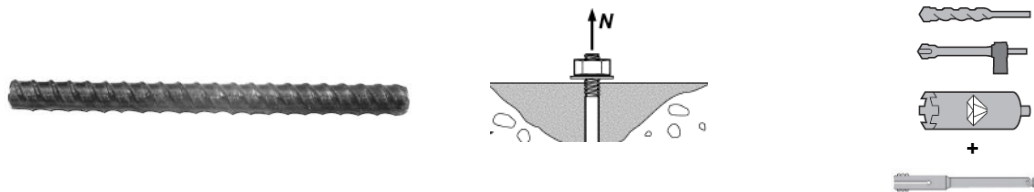

Barras de Refuerzo Canadienses

Resistencia al Arrancamiento del Concreto

Broca de Carburo o Broca Hueca de Carburo Hilti o Broca Corona de Diamante con Herramienta de Desbaste

TABLA 24—INFORMACIÓN DE DISEÑO DEL ARRANCAMIENTO DEL CONCRETO PARA BARRAS DE REFUERZO MÉTRICAS CANADIENSES EN AGUJEROS PERFORADOS CON ROTO MARTILLO Y BROCA DE CARBURO (O BROCA HUECA DE CARBURO HILTI) O PERFORADO CON BROCA CORONA DE DIAMANTE Y DESBASTADO CON HERRAMIENTA DE DESBASTE HILTI<sup>1</sup>

INFORMACIÓN DE DISEÑO			Símbolo	Unidades	Tamaño de la barra de refuerzo				
					10 M	15 M	20 M	25 M	30 M
Factor de efectividad para concreto fisurado			$k_{c,cr}$	SI (pulg.-lb)	7.1 (17)				
Factor de efectividad para concreto no fisurado			$k_{c,uncr}$	SI (pulg.-lb)	10 (24)				
Empotramiento mínimo			$h_{ef,min}$	mm (pulg.)	70 (2.8)	80 (3.1)	90 (3.5)	101 (4.0)	120 (4.7)
Empotramiento máximo			$h_{ef,max}$	mm (pulg.)	226 (8.9)	320 (12.6)	390 (15.4)	504 (19.8)	598 (23.5)
Separación mín. entre barras <sup>3</sup>			$s_{min}$	mm (pulg.)	57 (2.2)	80 (3.1)	98 (3.8)	126 (5.0)	150 (5.9)
Distancia mínima al borde <sup>3</sup>			$c_{min}$	mm (pulg.)	5d; o ver Sección 4.1.9.2 de este reporte para el diseño con distancias mínimas al borde reducidas				
Espesor mínimo del concreto			$h_{min}$	mm (pulg.)	$h_{ef} + 30$ ( $h_{ef} + 1\frac{1}{4}$ )	$h_{ef} + 2d_o^{(4)}$			
Distancia crítica al borde – hendimiento (para concreto no fisurado)			$c_{ac}$	-	Ver Sección 4.1.10.2 de este reporte.				
Factor de reducción de resistencia para la tensión, modos de falla del concreto, Condición B (sin reforzamiento suplementario) <sup>2</sup>			$\phi$	-	0.65				
Factor de reducción de resistencia para el cortante, modos de falla del concreto, Condición B (sin reforzamiento suplementario) <sup>2</sup>			$\phi$	-	0.70				

Para SI: 1 pulgada ≅ 25.4 mm, 1 lbf = 4.448 N, 1 psi = 0.006897 MPa.

Para unidades libra-pulgada: 1 mm = 0.03937 pulgadas, 1 N = 0.2248 lbf, 1 MPa = 145.0 psi

<sup>1</sup> Información de ajuste adicional se describe en la Figura 6, Instrucciones de instalación impresas del fabricante(MPII).

<sup>2</sup> El factor de reducción de resistencia se aplica cuando se usan las cargas combinadas del IBC o ACI 318 y se cumplen los requisitos de ACI 318-19 17.5.3, ACI 318-14 17.3.3 o ACI 318-11 D.4.3, según se aplique. Si se usan las cargas combinadas del Apéndice C de ACI 318-11, el valor apropiado del factor de reducción de resistencia debe determinarse de acuerdo con ACI 318-11 D.4.4.

<sup>3</sup> Para instalaciones con distancia al borde de 1<sup>3</sup>/<sub>4</sub>-pulgada, consulte la Sección 4.1.9.2 para los requerimientos de espaciado y torque máximo.

<sup>4</sup>  $d_o$  = diámetro del agujero.

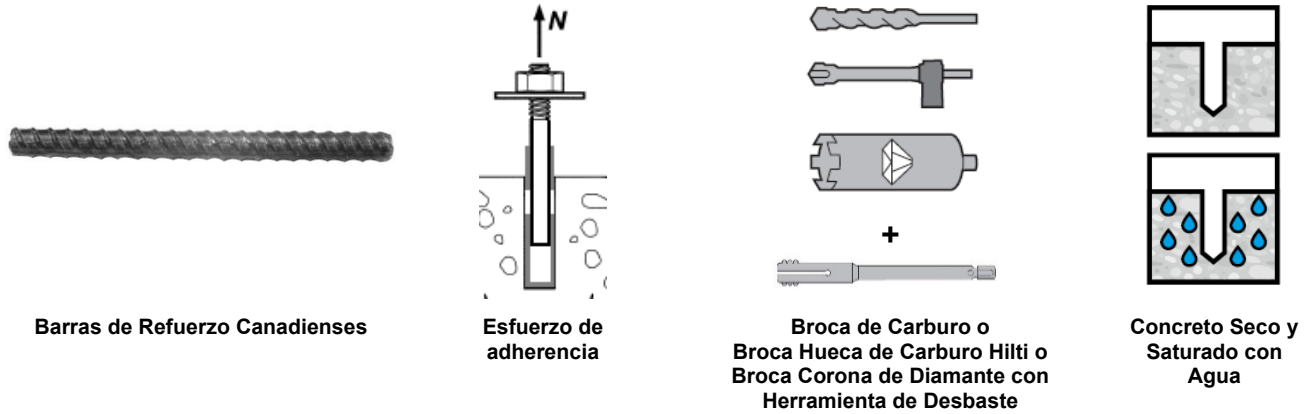

**TABLA 25—INFORMACIÓN DE DISEÑO DEL ESFUERZO DE ADHERENCIA PARA BARRAS DE REFUERZO MÉTRICAS CANADIENSES EN AGUJEROS PERFORADOS CON ROTO MARTILLO Y BROCA DE CARBURO (O BROCA HUECA DE CARBURO HILTI) O PERFORADO CON BROCA CORONA DE DIAMANTE Y DESBASTADO CON HERRAMIENTA DE DESBASTE HILTI<sup>1</sup>**

INFORMACIÓN DE DISEÑO		Símbolo	Unidades	Tamaño de la barra de refuerzo				
				10 M	15 M	20 M	25 M	30 M
Empotramiento mínimo		$h_{ef,min}$	mm (pulg.)	70 (2.8)	80 (3.1)	90 (3.5)	101 (4.0)	120 (4.7)
Empotramiento máximo		$h_{ef,max}$	mm (pulg.)	226 (8.9)	320 (12.6)	390 (15.4)	504 (19.8)	598 (23.5)
Temperatura rango A <sup>2</sup>	Esfuerzo característico de adherencia en concreto fisurado	$\tau_{k,cr}$	MPa (psi)	7.4 (1,075)	7.5 (1,085)	7.5 (1,095)	5.8 (840)	5.9 (850)
	Esfuerzo característico de adherencia en concreto no fisurado	$\tau_{k,uncr}$	MPa (psi)	10.8 (1,560)	10.8 (1,560)	10.8 (1,560)	10.8 (1,560)	10.8 (1,560)
Temperatura rango B <sup>2</sup>	Esfuerzo característico de adherencia en concreto fisurado	$\tau_{k,cr}$	MPa (psi)	7.4 (1,075)	7.5 (1,085)	7.5 (1,095)	5.8 (840)	5.9 (850)
	Esfuerzo característico de adherencia en concreto no fisurado	$\tau_{k,uncr}$	MPa (psi)	10.8 (1,560)	10.8 (1,560)	10.8 (1,560)	10.8 (1,560)	10.8 (1,560)
Temperatura rango C <sup>2</sup>	Esfuerzo característico de adherencia en concreto fisurado	$\tau_{k,cr}$	MPa (psi)	6.1 (885)	6.2 (895)	6.2 (900)	4.8 (690)	4.8 (700)
	Esfuerzo característico de adherencia en concreto no fisurado	$\tau_{k,uncr}$	MPa (psi)	8.8 (1,280)	8.8 (1,280)	8.8 (1,280)	8.8 (1,280)	8.8 (1,280)
Condiciones de instalación permisibles	Concreto Seco y Saturado con Agua	Categoría de Anclaje	-	1				
		$\phi_{cl}, \phi_{ws}$	-	0.65				
Reducción por tensión sísmica	Perforado con rotomartillo	$\alpha_{N,seis}$	-	0.80			0.85	0.97
	Perforado con diamante + desbaste	$\alpha_{N,seis}$	-	N/A	0.71	0.77	N/A	

Para SI: 1pulgada ≅ 25.4 mm, 1 lbf = 4.448 N, 1 psi = 0.006897 MPa.

Para unidades libra-pulgada: 1 mm = 0.03937 pulgadas, 1 N = 0.2248 lbf, 1 MPa = 145.0 psi

<sup>1</sup> Los valores del esfuerzo de adherencia corresponden a la resistencia del concreto a la compresión  $f'_c = 2,500$  psi (17.2 MPa). Para la resistencia a la compresión del concreto,  $f'_c$ , entre 2,500 psi (17.2 MPa) y 8,000 psi (55.2 MPa), el esfuerzo característico de adherencia tabulado puede incrementarse por el factor de  $(f'_c / 2,500)^{0.1}$  [Para SI:  $(f'_c / 17.2)^{0.1}$ ]. Ver la Sección 4.1.4 de este reporte para la determinación del esfuerzo de adherencia.

<sup>2</sup> Temperatura rango A: Temperatura máxima a corto plazo = 130°F (55°C), Temperatura máxima a largo plazo = 110°F (43°C).

Temperatura rango B: Temperatura máxima a corto plazo = 176°F (80°C), Temperatura máxima a largo plazo = 110°F (43°C).

Temperatura rango C: Temperatura máxima a corto plazo = 248°F (120°C), Temperatura máxima a largo plazo = 162°F (72°C).

Las temperaturas elevadas a corto plazo del concreto son aquellas que ocurren a intervalos cortos, por ejemplo, como resultado del ciclo diurno. Las temperaturas a largo plazo son constantes a lo largo de periodos significativos de tiempo.

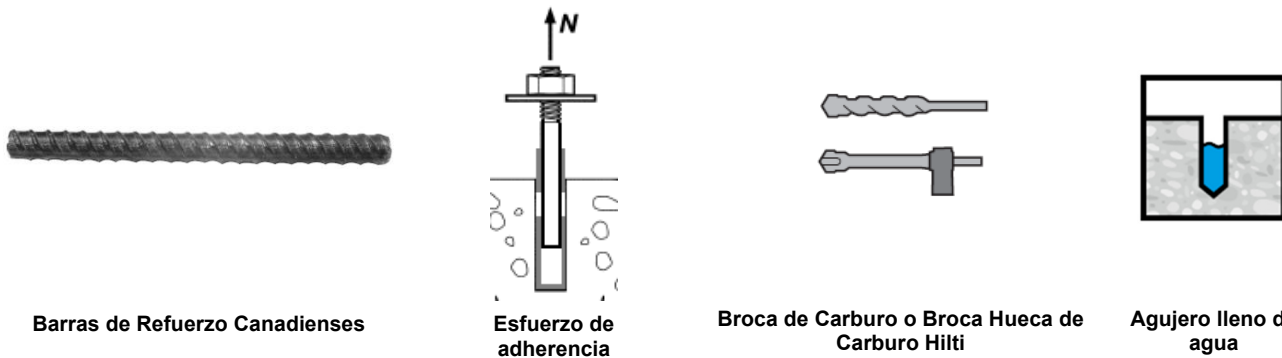

Barras de Refuerzo Canadienses

Esfuerzo de adherencia

Broca de Carburo o Broca Hueca de Carburo Hilti

Agujero lleno de agua

**TABLA 26—INFORMACIÓN DE DISEÑO DEL ESFUERZO DE ADHERENCIA PARA BARRAS DE REFUERZO MÉTRICAS CANADIENSES EN AGUJEROS PERFORADOS CON ROTO MARTILLO Y BROCA DE CARBURO (O BROCA HUECA DE CARBURO HILTI)**

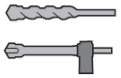
INFORMACIÓN DE DISEÑO		Símbolo	Unidades	Tamaño de la barra de refuerzo				
				10 M	15 M	20 M	25 M	30 M
Empotramiento mínimo		$h_{ef,min}$	mm (pulg.)	70 (2.8)	80 (3.1)	90 (3.5)	101 (4.0)	120 (4.7)
Empotramiento máximo		$h_{ef,max}$	mm (pulg.)	226 (8.9)	320 (12.6)	390 (15.4)	504 (19.8)	598 (23.5)
Temperatura rango A <sup>2</sup>	Esfuerzo característico de adherencia en concreto fisurado	$\tau_{k,cr}$	MPa (psi)	7.3 (1,050)	7.4 (1,070)	7.4 (1,070)	5.7 (820)	5.8 (830)
	Esfuerzo característico de adherencia en concreto no fisurado	$\tau_{k,uncr}$	MPa (psi)	10.5 (1,520)	10.5 (1,520)	10.5 (1,520)	10.5 (1,520)	10.5 (1,520)
Temperatura rango B <sup>2</sup>	Esfuerzo característico de adherencia en concreto fisurado	$\tau_{k,cr}$	MPa (psi)	7.3 (1,050)	7.4 (1,070)	7.4 (1,070)	5.7 (820)	5.8 (830)
	Esfuerzo característico de adherencia en concreto no fisurado	$\tau_{k,uncr}$	MPa (psi)	10.5 (1,520)	10.5 (1,520)	10.5 (1,520)	10.5 (1,520)	10.5 (1,520)
Temperatura rango C <sup>2</sup>	Esfuerzo característico de adherencia en concreto fisurado	$\tau_{k,cr}$	MPa (psi)	6.0 (865)	6.1 (875)	6.1 (875)	4.7 (680)	6.0 (865)
	Esfuerzo característico de adherencia en concreto no fisurado	$\tau_{k,uncr}$	MPa (psi)	8.6 (1,250)	8.6 (1,250)	8.6 (1,250)	8.6 (1,250)	8.6 (1,250)
Condiciones de instalación permisibles	Agujero lleno de agua 	Categoría de Anclaje	-	3				
		$\phi_{wt}$	-	0.45				
Reducción por tensión sísmica	 Perforado con roto martillo	$\alpha_{N,seis}$	-	0.80			0.85	0.97

Para SI: 1 pulgada  $\equiv$  25.4 mm, 1 lbf = 4.448 N, 1 psi = 0.006897 MPa.  
 Para unidades libra-pulgada: 1 mm = 0.03937 pulgadas, 1 N = 0.2248 lbf, 1 MPa = 145.0 psi

<sup>1</sup> Los valores del esfuerzo de adherencia corresponden a la resistencia del concreto a la compresión  $f'_c = 2,500$  psi (17.2 MPa). Para la resistencia a la compresión del concreto,  $f'_c$ , entre 2,500 psi (17.2 MPa) y 8,000 psi (55.2 MPa), el esfuerzo característico de adherencia tabulado puede incrementar por el factor de  $(f'_c / 2,500)^{0.1}$  [Para SI:  $(f'_c / 17.2)^{0.1}$ ]. Ver la Sección 4.1.4 de este reporte para la determinación del esfuerzo de adherencia.

<sup>2</sup> Temperatura rango A: Temperatura máxima a corto plazo = 130°F (55°C), Temperatura máxima a largo plazo = 110°F (43°C).

Temperatura rango B: Temperatura máxima a corto plazo = 176°F (80°C), Temperatura máxima a largo plazo = 110°F (43°C).

Temperatura rango C: Temperatura máxima a corto plazo = 248°F (120°C), Temperatura máxima a largo plazo = 162°F (72°C).

Las temperaturas elevadas a corto plazo del concreto son aquellas que ocurren a intervalos cortos, por ejemplo, como resultado del ciclo diurno. Las temperaturas a largo plazo son constantes a lo largo de periodos significativos de tiempo.



Inserto HIS-N y HIS-RN de roscado interno fraccional y métrico

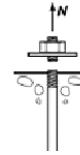

Resistencia del Acero

TABLA 27—INFORMACIÓN DEL DISEÑO DEL ACERO PARA INSERTOS ROSCADOS HIS-N Y HIS-RN FRACCIONALES Y MÉTRICOS<sup>1</sup>

INFORMACIÓN DE DISEÑO		Símbolo	Unidades	Diámetro nominal del perno/tornillo con cabeza (pulg.) Fraccional				Unidades	Diámetro nominal del perno/tornillo con cabeza (mm) Métrico				
				3/8	1/2	5/8	3/4		8	10	12	16	20
Diámetro exterior del inserto HIS		<i>D</i>	pulg. (mm)	0.65 (16.5)	0.81 (20.5)	1.00 (25.4)	1.09 (27.6)	mm (pulg.)	12.5 (0.49)	16.5 (0.65)	20.5 (0.81)	25.4 (1.00)	27.6 (1.09)
Longitud del inserto HIS		<i>L</i>	pulg. (mm)	4.33 (110)	4.92 (125)	6.69 (170)	8.07 (205)	mm (pulg.)	90 (3.54)	110 (4.33)	125 (4.92)	170 (6.69)	205 (8.07)
Área efectiva de la sección transversal del perno		<i>A<sub>se</sub></i>	pulg. <sup>2</sup> (mm <sup>2</sup> )	0.077 (50)	0.1419 (92)	0.2260 (146)	0.3345 (216)	mm <sup>2</sup> (pulg. <sup>2</sup> )	36.6 (0.057)	58 (0.090)	84.3 (0.131)	157 (0.243)	245 (0.380)
Área efectiva de la sección transversal de inserto HIS		<i>A<sub>insert</sub></i>	pulg. <sup>2</sup> (mm <sup>2</sup> )	0.178 (115)	0.243 (157)	0.404 (260)	0.410 (265)	mm <sup>2</sup> (pulg. <sup>2</sup> )	51.5 (0.080)	108 (0.167)	169.1 (0.262)	256.1 (0.397)	237.6 (0.368)
ASTM A193 B7	Resistencia nominal del acero – ASTM A193 B7 <sup>3</sup> perno/tornillo con cabeza	<i>N<sub>sa</sub></i>	lb (kN)	9,690 (43.1)	17,740 (78.9)	28,250 (125.7)	41,815 (186.0)	kN (lb)	-	-	-	-	-
		<i>V<sub>sa</sub></i>	lb (kN)	5,815 (25.9)	10,645 (47.3)	16,950 (75.4)	25,090 (111.6)	kN (lb)	-	-	-	-	-
	Resistencia nominal del acero – Inserto HIS-N	<i>N<sub>sa</sub></i>	lb (kN)	12,650 (56.3)	16,195 (72.0)	26,925 (119.8)	27,360 (121.7)	kN (lb)	-	-	-	-	-
ASTM A193 Grado B8M SS	Resistencia nominal del acero – ASTM A193 Grado B8M SS perno/tornillo con cabeza	<i>N<sub>sa</sub></i>	lb (kN)	8,525 (37.9)	15,610 (69.4)	24,860 (110.6)	36,795 (163.7)	kN (lb)	-	-	-	-	-
		<i>V<sub>sa</sub></i>	lb (kN)	5,115 (22.8)	9,365 (41.7)	14,915 (66.3)	22,075 (98.2)	kN (lb)	-	-	-	-	-
	Resistencia nominal del acero – Inserto HIS-RN	<i>N<sub>sa</sub></i>	lb (kN)	17,165 (76.3)	23,430 (104.2)	38,955 (173.3)	39,535 (175.9)	kN (lb)	-	-	-	-	-
ISO 898-1 Clase 8.8	Resistencia nominal del acero – ISO 898-1 Clase 8.8 perno/tornillo con cabeza	<i>N<sub>sa</sub></i>	lb (kN)	-	-	-	-	kN (lb)	29.5 (6,582)	46.5 (10,431)	67.5 (15,161)	125.5 (28,236)	196.0 (44,063)
		<i>V<sub>sa</sub></i>	lb (kN)	-	-	-	-	kN (lb)	17.5 (3,949)	28.0 (6,259)	40.5 (9,097)	75.5 (16,942)	117.5 (26,438)
	Resistencia nominal del acero – Inserto HIS-N	<i>N<sub>sa</sub></i>	lb (kN)	-	-	-	-	kN (lb)	25.0 (5,669)	53.0 (11,894)	78.0 (17,488)	118.0 (26,483)	110.0 (24,573)
ISO 3506-1 Clase A4-70 Inoxidable	Resistencia nominal del acero – ISO 3506-1 Clase A4-70 Inoxidable perno/tornillo con cabeza	<i>N<sub>sa</sub></i>	lb (kN)	-	-	-	-	kN (lb)	25.5 (5,760)	40.5 (9,127)	59.0 (13,266)	110.0 (24,706)	171.5 (38,555)
		<i>V<sub>sa</sub></i>	lb (kN)	-	-	-	-	kN (lb)	15.5 (3,456)	24.5 (5,476)	35.5 (7,960)	66.0 (14,824)	103.0 (23,133)
	Resistencia nominal del acero – Inserto HIS-RN	<i>N<sub>sa</sub></i>	lb (kN)	-	-	-	-	kN (lb)	36.0 (8,099)	75.5 (16,991)	118.5 (26,612)	179.5 (40,300)	166.5 (37,394)
Reducción para el cortante sísmico		$\alpha_{V,seis}$	-	0.94				-	0.94				
Factor de reducción de resistencia para la tensión <sup>2</sup>		$\phi$	-	0.65				-	0.65				
Factor de reducción de resistencia para el cortante <sup>2</sup>		$\phi$	-	0.60				-	0.60				

Para SI: 1 pulgada ≅ 25.4 mm, 1 lbf = 4.448 N, 1 psi = 0.006897MPa.  
 Para unidades libra-pulgada: 1 mm = 0.03937 pulgadas, 1 N = 0.2248 lbf, 1 MPa = 145.0 psi

<sup>1</sup> Los valores proporcionados para los tipos de materiales de la varilla común se basan en resistencias especificadas y calculadas de acuerdo con ACI 318-19 Ec. (17.6.1.2), ACI 318-14 Ec. (17.4.1.2), ACI 318-11 Ec. (D-2) y Ec. (D-29). Las tuercas y arandelas deben ser apropiadas para la varilla.

<sup>2</sup> El factor de reducción de resistencia se aplica cuando se usan las cargas combinadas del IBC o ACI 318 y se cumplen los requisitos de ACI 318-19 17.5.3, ACI 318-14 17.3.3 o ACI 318-11 D.4.3, según se aplique. Si se usan las cargas combinadas del Apéndice C de ACI 318-11, el valor apropiado del factor de reducción de resistencia debe determinarse de acuerdo con ACI 318-11 D.4.4.

<sup>3</sup> Para calcular el diseño de la resistencia del acero en tensión y cortante para el perno o tornillo, se puede utilizar el factor  $\phi$  para falla del acero dúctil de acuerdo con ACI 318-19 17.5.3, ACI 318-14 17.3.3 o ACI 318-11 D.4.3.



Inserto HIS-N y HIS-RN de roscado interno fraccional y métrico

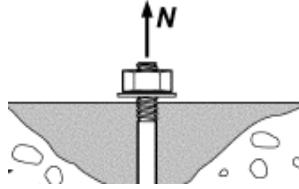

Resistencia al Arrancamiento del Concreto

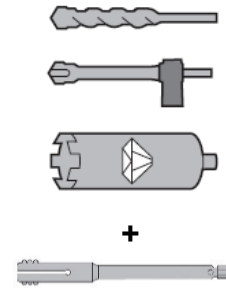

Broca de Carburo o Broca Hueca de Carburo Hilti o Broca Corona de Diamante con Herramienta de Desbaste

**TABLA 28—INFORMACIÓN DE DISEÑO DEL ARRANCAMIENTO DEL CONCRETO PARA INSERTOS HILTI HIS-N Y HIS-RN FRACCIONALES Y MÉTRICOS EN AGUJEROS PERFORADOS CON ROTO MARTILLO Y BROCA DE CARBURO (O BROCA HUECA DE CARBURO HILTI) O PERFORADO CON BROCA CORONA DE DIAMANTE Y DESBASTADO CON HERRAMIENTA DE DESBASTE HILTI<sup>1</sup>**

INFORMACIÓN DE DISEÑO	Símbolo	Unidades	Diámetro nominal del perno/tornillo con cabeza (pulg.) Fraccional				Unidades	Diámetro nominal del perno/tornillo con cabeza (mm) Métrico				
			3/8	1/2	5/8	3/4		8	10	12	16	20
Factor de efectividad para concreto fisurado	$k_{c,cr}$	pulg-lb (SI)	17 (7.1)				SI (pulg-lb)	7.1 (17)				
Factor de efectividad para concreto no fisurado	$k_{c,uncr}$	pulg-lb (SI)	24 (10)				SI (pulg-lb)	10 (24)				
Profundidad de empotramiento efectiva	$h_{ef}$	pulg. (mm)	4 <sup>3/8</sup> (110)	5 (125)	6 <sup>3/4</sup> (170)	8 <sup>1/8</sup> (205)	mm (pulg.)	90 (3.5)	110 (4.3)	125 (4.9)	170 (6.7)	205 (8.1)
Separación mínima entre anclajes <sup>3</sup>	$s_{min}$	pulg. (mm)	3 <sup>1/4</sup> (83)	4 (102)	5 (127)	5 <sup>1/2</sup> (140)	mm (pulg.)	63 (2.5)	83 (3.25)	102 (4.0)	127 (5.0)	140 (5.5)
Distancia mínima al borde <sup>3</sup>	$c_{min}$	pulg. (mm)	3 <sup>1/4</sup> (83)	4 (102)	5 (127)	5 <sup>1/2</sup> (140)	mm (pulg.)	63 (2.5)	83 (3.25)	102 (4.0)	127 (5.0)	140 (5.5)
Espesor mínimo del concreto	$h_{min}$	pulg. (mm)	5.9 (150)	6.7 (170)	9.1 (230)	10.6 (270)	mm (pulg.)	120 (4.7)	150 (5.9)	170 (6.7)	230 (9.1)	270 (10.6)
Distancia crítica al borde – hendimiento (para concreto no fisurado)	$c_{ac}$	-	Ver Sección 4.1.10.2 de este reporte				-	Ver Sección 4.1.10.2 de este reporte				
Factor de reducción de resistencia para la tensión, modos de falla del concreto, Condición B (sin reforzamiento suplementario) <sup>2</sup>	$\phi$	-	0.65				-	0.65				
Factor de reducción de resistencia para el cortante, modos de falla del concreto, Condición B (sin reforzamiento suplementario) <sup>2</sup>	$\phi$	-	0.70				-	0.70				

Para SI: 1 pulgada  $\approx$  25.4 mm, 1 lbf = 4.448 N, 1 psi = 0.006897MPa.  
 Para unidades libra-pulgada: 1 mm = 0.03937 pulgadas, 1 N = 0.2248 lbf, 1 MPa = 145.0 psi

<sup>1</sup> Información de ajuste adicional se describe en la Figura 6, Instrucciones de instalación impresas del fabricante(MPII).  
<sup>2</sup> El factor de reducción de resistencia se aplica cuando se usan las cargas combinadas del IBC o ACI 318 y se cumplen los requisitos de ACI 318-19 17.5.3, ACI 318-14 17.3.3 o ACI 318-11 D.4.3, según se aplique. Si se usan las cargas combinadas del Apéndice C de ACI 318-11, el valor apropiado del factor de reducción de resistencia debe determinarse de acuerdo con ACI 318-11 D.4.4.  
<sup>3</sup> Para instalaciones con distancia al borde de 1<sup>3/4</sup>-pulgada, consulte la Sección 4.1.9.2 para los requerimientos de espaciado y torque máximo.

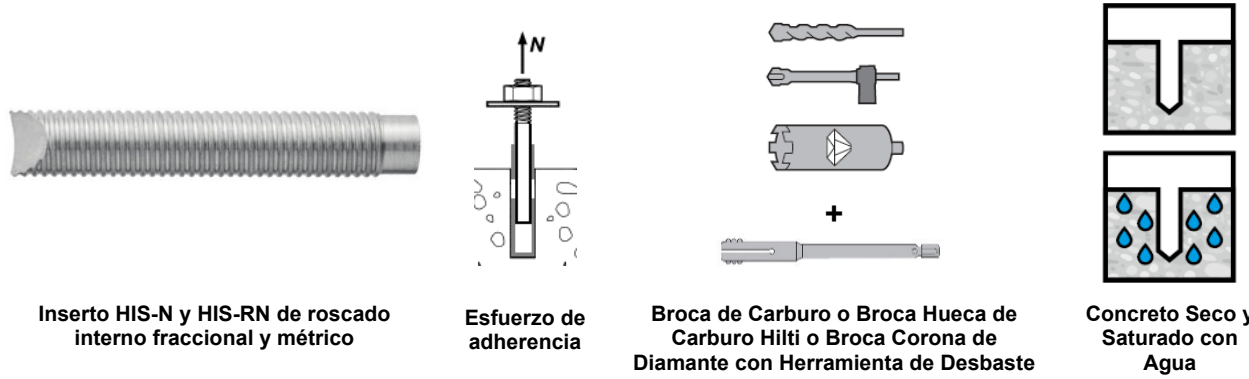

Inserto HIS-N y HIS-RN de roscado interno fraccional y métrico

Esfuerzo de adherencia

Broca de Carburo o Broca Hueca de Carburo Hilti o Broca Corona de Diamante con Herramienta de Desbaste

Concreto Seco y Saturado con Agua

**TABLA 29—INFORMACIÓN DE DISEÑO DEL ESFUERZO DE ADHERENCIA PARA INSERTOS HILTI HIS-N Y HIS-RN FRACCIONALES Y MÉTRICOS EN AGUJEROS PERFORADOS CON ROTO MARTILLO Y BROCA DE CARBURO (O BROCA HUECA DE CARBURO HILTI)<sup>1</sup>**

INFORMACIÓN DE DISEÑO		Sim-bolo	Unida-des	Diámetro nominal del perno/tornillo con cabeza (pulg.) Fraccional				Uni-dades	Diámetro nominal del perno/tornillo con cabeza (mm) Métrico				
				3/8	1/2	5/8	3/4		8	10	12	16	20
Profundidad de empotramiento efectiva		$h_{ef}$	pulg. (mm)	4 <sup>3/8</sup> (110)	5 (125)	6 <sup>3/4</sup> (170)	8 <sup>1/8</sup> (205)	mm (pulg.)	90 (3.5)	110 (4.3)	125 (4.9)	170 (6.7)	205 (8.1)
Diámetro exterior del inserto HIS		$D$	pulg. (mm)	0.65 (16.5)	0.81 (20.5)	1.00 (25.4)	1.09 (27.6)	mm (pulg.)	12.5 (0.49)	16.5 (0.65)	20.5 (0.81)	25.4 (1.00)	27.6 (1.09)
Temperatura rango A <sup>2</sup>	Esfuerzo característico de adherencia en concreto fisurado	$\bar{\tau}_{k,cr}$	psi (MPa)	870 (6.0)	890 (6.1)	910 (6.3)	920 (6.3)	MPa (psi)	5.9 (850)	6.0 (870)	6.1 (890)	6.3 (910)	6.3 (920)
	Esfuerzo característico de adherencia en concreto no fisurado	$\bar{\tau}_{k,uncr}$	psi (MPa)	1,950 (13.5)	1,950 (13.5)	1,950 (13.5)	1,950 (13.5)	MPa (psi)	13.5 (1,950)	13.5 (1,950)	13.5 (1,950)	13.5 (1,950)	13.5 (1,950)
Temperatura rango B <sup>2</sup>	Esfuerzo característico de adherencia en concreto fisurado	$\bar{\tau}_{k,cr}$	psi (MPa)	870 (6.0)	890 (6.1)	910 (6.3)	920 (6.3)	MPa (psi)	5.9 (850)	6.0 (870)	6.1 (890)	6.3 (910)	6.3 (920)
	Esfuerzo característico de adherencia en concreto no fisurado	$\bar{\tau}_{k,uncr}$	psi (MPa)	1,950 (13.5)	1,950 (13.5)	1,950 (13.5)	1,950 (13.5)	MPa (psi)	13.5 (1,950)	13.5 (1,950)	13.5 (1,950)	13.5 (1,950)	13.5 (1,950)
Temperatura rango C <sup>2</sup>	Esfuerzo característico de adherencia en concreto fisurado	$\bar{\tau}_{k,cr}$	psi (MPa)	715 (4.9)	730 (5.0)	750 (5.2)	755 (5.2)	MPa (psi)	4.8 (695)	4.9 (715)	5.0 (730)	5.2 (750)	5.2 (755)
	Esfuerzo característico de adherencia en concreto no fisurado	$\bar{\tau}_{k,uncr}$	psi (MPa)	1,600 (11.0)	1,600 (11.0)	1,600 (11.0)	1,600 (11.0)	MPa (psi)	11.0 (1,600)	11.0 (1,600)	11.0 (1,600)	11.0 (1,600)	11.0 (1,600)
Condiciones de instalación	Concreto seco y saturado con agua	Categoría de Anclaje	-	1				-	1				
		$\phi_d, \phi_{ws}$	-	0.65				-	0.65				
Reducción por tensión sísmica	Perforado con rotomartillo	$\alpha_{N,seis}$	-	0.92				-	0.92				
	Perforado con diamante + desbaste	$\alpha_{N,seis}$	-	0.81	0.88	0.92	0.76	-	N/A	0.81	0.88	0.92	0.76

Para SI: 1 pulgada  $\equiv$  25.4 mm, 1 lbf = 4.448 N, 1 psi = 0.006897 MPa.  
 Para unidades libra-pulgada: 1 mm = 0.03937 pulgadas, 1 N = 0.2248 lbf, 1 MPa = 145.0 psi

<sup>1</sup> Los valores del esfuerzo de adherencia corresponden a la resistencia del concreto a la compresión  $f'_c = 2,500$  psi (17.2 MPa). Para la resistencia a la compresión del concreto,  $f'_c$ , entre 2,500 psi (17.2 MPa) y 8,000 psi (55.2 MPa), el esfuerzo característico de adherencia tabulado puede incrementarse por el factor de  $(f'_c / 2,500)^{0.1}$  para concreto no fisurado, [Para SI:  $(f'_c / 17.2)^{0.1}$ ] and  $(f'_c / 2,500)^{0.3}$  para concreto fisurado, [Para SI:  $(f'_c / 17.2)^{0.3}$ ]. Ver la Sección 4.1.4 de este reporte para la determinación del esfuerzo de adherencia.

<sup>2</sup> Temperatura rango A: Temperatura máxima a corto plazo = 130°F (55°C), Temperatura máxima a largo plazo = 110°F (43°C).  
 Temperatura rango B: Temperatura máxima a corto plazo = 176°F (80°C), Temperatura máxima a largo plazo = 110°F (43°C).  
 Temperatura rango C: Temperatura máxima a corto plazo = 248°F (120°C), Temperatura máxima a largo plazo = 162°F (72°C).  
 Las temperaturas elevadas a corto plazo del concreto son aquellas que ocurren a intervalos cortos, por ejemplo, como resultado del ciclo diario. Las temperaturas a largo plazo son constantes a lo largo de periodos significativos de tiempo.



FIGURA 5—SISTEMA DE ANCLAJE HILTI HIT-HY 200 V3

TABLA 30—LONGITUD DE DESARROLLO PARA BARRAS DE REFUERZO USUALES EN U.S. EN AGUJEROS PERFORADOS CON ROTO MARTILLO Y BROCA DE CARBURO O BROCA HUECA DE CARBURO HILTI<sup>1, 2, 4</sup>

INFORMACIÓN DE DISEÑO	Símbolo	Criterios de la Sección de la Norma Citada	Unidades	Tamaño de la barra							
				#3	#4	#5	#6	#7	#8	#9	#10
Diámetro nominal de la barra de refuerzo	$d_b$	ASTM A615/A706	pulg. (mm)	0.375 (9.5)	0.500 (12.7)	0.625 (15.9)	0.750 (19.1)	0.875 (22.2)	1.000 (25.4)	1.128 (28.7)	1.270 (32.3)
Área nominal de la barra	$A_b$	ASTM A615/A706	pulg. <sup>2</sup> (mm <sup>2</sup> )	0.11 (71)	0.20 (129)	0.31 (199)	0.44 (284)	0.60 (387)	0.79 (510)	1.00 (645)	1.27 (819)
Longitud de Desarrollo para $f_y = 60$ ksi y $f'_c = 2,500$ psi (concreto de densidad normal) <sup>3</sup>	$l_d$	ACI 318-19 25.4.2.4 ACI 318-14 25.4.2.3 ACI 318-11 12.2.3	pulg. (mm)	12.0 (304.8)	14.4 (365.8)	18.0 (457.2)	21.6 (548.6)	31.5 (800.1)	36.0 (914.4)	40.6 (1031.4)	45.7 (1161.3)
Longitud de Desarrollo para $f_y = 60$ ksi y $f'_c = 4,000$ psi (concreto de densidad normal) <sup>3</sup>	$l_d$	ACI 318-19 25.4.2.4 ACI 318-14 25.4.2.3 ACI 318-11 12.2.3	pulg. (mm)	12.0 (304.8)	12.0 (304.8)	14.2 (361.4)	17.1 (433.7)	24.9 (632.5)	28.5 (722.9)	32.1 (815.4)	36.1 (918.1)

Para SI: 1 pulgada  $\equiv$  25.4 mm, 1 lbf = 4.448 N, 1 psi = 0.006897 MPa.  
 Para unidades libra-pulgada: 1 mm = 0.03937 pulgadas, 1 N = 0.2248 lbf, 1 MPa = 145.0 psi

<sup>1</sup> Longitudes de desarrollo válidas para cargas estáticas, de viento y de sismo (SDC A y B).  
<sup>2</sup> Las longitudes de desarrollo en las SDC C a la F deben cumplir con ACI 318-19 y ACI 318-14 Capítulo 18 o ACI 318-11 Capítulo 21 y sección 4.2.4 de este reporte.  
<sup>3</sup> Para concreto de arena de densidad liviana, incrementar la longitud de desarrollo en 33%, a menos que se cumplan las disposiciones de ACI 318-19 25.4.2.5, ACI 318-14 25.4.2.4 o ACI 318-11 12.2.4 (d) para permitir  $\lambda > 0.75$ .

$$^4 \left( \frac{c_b + K_{tr}}{d_b} \right) = 2.5, \psi_t = 1.0, \psi_e = 1.0, \psi_s = 0.8 \text{ para } d_b \leq \#6, 1.0 \text{ para } d_b > \#6.$$



**TABLA 31—LONGITUD DE DESARROLLO PARA BARRAS DE REFUERZO MÉTRICAS EU EN AGUJEROS PERFORADOS CON ROTO MARTILLO Y BROCA DE CARBURO O BROCA HUECA DE CARBURO HILTI<sup>1, 2, 4</sup>**

INFORMACIÓN DE DISEÑO	Símbolo	Criterios de la Sección de la Norma Citada	Unidades	Tamaño de la barra						
				8	10	12	16	20	25	32
Diámetro nominal de la barra de refuerzo	$d_b$	BS 4449: 2005	mm (pulg.)	8 (0.315)	10 (0.394)	12 (0.472)	16 (0.630)	20 (0.787)	25 (0.984)	32 (1.260)
Área nominal de la barra	$A_b$	BS 4449: 2005	mm <sup>2</sup> (pulg. <sup>2</sup> )	50.3 (0.08)	78.5 (0.12)	113.1 (0.18)	201.1 (0.31)	314.2 (0.49)	490.9 (0.76)	804.2 (1.25)
Longitud de desarrollo para $f_y = 72.5$ ksi y $f'_c = 2,500$ psi (concreto de densidad normal) <sup>3</sup>	$l_d$	ACI 318-19 25.4.2.4 <sup>5</sup> ACI 318-14 25.4.2.3 ACI 318-11 12.2.3	Mm (pulg.)	305 (12.0)	348 (13.7)	417 (16.4)	556 (21.9)	871 (34.3)	1087 (42.8)	1392 (54.8)
Longitud de desarrollo para $f_y = 72.5$ ksi and $f'_c = 4,000$ psi (concreto de densidad normal) <sup>3</sup>	$l_d$	ACI 318-19 25.4.2.4 <sup>5</sup> ACI 318-14 25.4.2.3 ACI 318-11 12.2.3	mm (pulg.)	305 (12.0)	305 (12.0)	330 (13.0)	439 (17.3)	688 (27.1)	859 (33.8)	1100 (43.3)

Para SI: 1 pulgada  $\equiv$  25.4 mm, 1 lbf = 4.448 N, 1 psi = 0.006897 MPa.  
Para unidades libra-pulgada: 1 mm = 0.03937 pulgadas, 1 N = 0.2248 lbf, 1 MPa = 145.0 psi

<sup>1</sup>Longitudes de desarrollo válidas para cargas estáticas, de viento y de sismo (SDC A y B).

<sup>2</sup>Las longitudes de desarrollo en las SDC C a la F deben cumplir con ACI 318-19 and ACI 318-14 Capítulo 18 o ACI 318-11 Capítulo 21 y sección 4.2.4 de este reporte.

<sup>3</sup>Para concreto de arena de densidad liviana, incrementar la longitud de desarrollo en 33%, a menos que se cumplan las disposiciones de ACI 318-19 25.4.2.5, ACI 318-14 25.4.2.4 o ACI 318-11 12.2.4 (d) para permitir  $\lambda > 0.75$ .

<sup>4</sup> $\left(\frac{c_b + K_{tr}}{d_b}\right) = 2.5$ ,  $\psi_t = 1.0$ ,  $\psi_e = 1.0$ ,  $\psi_s = 0.8$  para  $d_b < 20$ mm, 1.0 para  $d_b \geq 20$ mm.

<sup>5</sup> $l_d$  debe aumentar un 9.5% para contar  $\psi_s$  en ACI 318-19 25.4.2.4.  $\psi_s$  ha sido interpolado por la Tabla 25.4.2.5 de ACI 318-10 para  $f_y = 72.5$  ksi.

**TABLA 32—LONGITUD DE DESARROLLO PARA BARRAS DE REFUERZO CANADIENSES MÉTRICAS EN AGUJEROS PERFORADOS CON ROTO MARTILLO Y BROCA DE CARBURO O BROCA HUECA DE CARBURO HILTI<sup>1, 2, 4</sup>**

INFORMACIÓN DE DISEÑO	Símbolo	Criterios de la Sección de la Norma Citada	Unidades	Tamaño de la Barra				
				10M	15M	20M	25M	30M
Diámetro nominal de la barra de refuerzo	$d_b$	CAN/CSA-G30.18 Gr. 400	mm (pulg.)	11.3 (0.445)	16.0 (0.630)	19.5 (0.768)	25.2 (0.992)	29.9 (1.177)
Área nominal de la barra	$A_b$	CAN/CSA-G30.18 Gr. 400	mm <sup>2</sup> (pulg. <sup>2</sup> )	100.3 (0.16)	201.1 (0.31)	298.6 (0.46)	498.8 (0.77)	702.2 (1.09)
Longitud de desarrollo para $f_y = 58$ ksi and $f'_c = 2,500$ psi (concreto de densidad normal) <sup>3</sup>	$l_d$	ACI 318-19 25.4.2.4 ACI 318-14 25.4.2.3 ACI 318-11 12.2.3	mm (pulg.)	315 (12.4)	445 (17.5)	678 (26.7)	876 (34.5)	1041 (41.0)
Longitud de desarrollo para $f_y = 58$ ksi and $f'_c = 4,000$ psi (concreto de densidad normal) <sup>3</sup>	$l_d$	ACI 318-19 25.4.2.4 ACI 318-14 25.4.2.3 ACI 318-11 12.2.3	mm (pulg.)	305 (12.0)	353 (13.9)	536 (21.1)	693 (27.3)	823 (32.4)

Para SI: 1 pulgada  $\equiv$  25.4 mm, 1 lbf = 4.448 N, 1 psi = 0.006897 MPa.  
Para unidades libra-pulgada: 1 mm = 0.03937 pulgadas, 1 N = 0.2248 lbf, 1 MPa = 145.0 psi

<sup>1</sup> Longitudes de desarrollo válidas para cargas estáticas, de viento y de sismo (SDC A y B).

<sup>2</sup> Las longitudes de desarrollo en las SDC C a la F deben cumplir con ACI 318-19 y ACI 318-14 Capítulo 18 o ACI 318-11 Capítulo 21 y la Sección 4.2.4 de este reporte.

<sup>3</sup> Para concreto de arena de densidad liviana, incrementar la longitud de desarrollo en 33%, a menos que se cumplan las disposiciones de ACI 318-19 25.4.2.5, ACI 318-14 25.4.2.4 o ACI 318-11 12.2.4 (d) para permitir  $\lambda > 0.75$ .

<sup>4</sup> $\left(\frac{c_b + K_{tr}}{d_b}\right) = 2.5$ ,  $\psi_t = 1.0$ ,  $\psi_e = 1.0$ ,  $\psi_s = 0.8$  para  $d_b < 20$ M, 1.0 para  $d_b \geq 20$ M.



English  
Français  
Español  
Português

Hilti HIT-HY 200-A V3  
Hilti HIT-HY 200-R V3



**Atención**

Contiene: metacrilato de hidroxipropilo (A), 2,2'-(m-tolilimino)di-etanol (A), Dimetacrilato de 1,4-butanodiol (A), peróxido de dibenzilo (B). Puede provocar una reacción alérgica en la piel. (A,B) Provoca irritación ocular grave. (B) Muy tóxico para los organismos acuáticos, con efectos nocivos duraderos. (B)

Hilti HIT-HY 200-A/R V3

1	7	13	19
2	8	14	20
3	9	15	21
4	10	16	
5	11	17	
6	12	18	

Barra de refuerzo  $h_{ef} \geq 20d$

		$h_{ef}$		
HIT-HY 200-A HIT-HY 200-R V3	HDM, HDE	≤ US #5 ≤ EU 16mm ≤ CAN 15M	12 1/2 ... 37 1/2 [pulg] 320 ... 960 [mm]	14°F...104°F -10°C...40°C
HIT-HY 200-A HIT-HY 200-R V3	HDE	≤ US #5 ≤ EU 16mm ≤ CAN 15M	12 1/2 ... 37 1/2 [pulg] 320 ... 960 [mm]	32°F...86°F 0°C...30°C
HIT-HY 200-R V3	HDE	≤ US #8 ≤ EU 25mm ≤ CAN 25M	20 ... 60 [pulg] 500 ... 1500 [mm]	32°F...104°F 0°C...40°C
HIT-HY 200-R V3	HDE	≤ US #10 ≤ EU 32mm ≤ CAN 30M	25 ... 75 [pulg] 640 ... 1920 [mm]	50°F...86°F 10°C...30°C

		$h_{ef}$		
HIT-HY 200-A HIT-HY 200-R V3	HDM, HDE	≤ US #5 ≤ EU 16mm ≤ CAN 15M	12 1/2 ... 37 1/2 [pulg] 320 ... 960 [mm]	14°F...104°F -10°C...40°C
HIT-HY 200-A HIT-HY 200-R V3	HDE	≤ US #5 ≤ EU 16mm ≤ CAN 15M	12 1/2 ... 37 1/2 [pulg] 320 ... 960 [mm]	32°F...86°F 0°C...30°C
HIT-HY 200-R V3	HDE	≤ US #8 ≤ EU 25mm ≤ CAN 25M	20 ... 39 3/8 [pulg] 500 ... 1000 [mm]	32°F...104°F 0°C...40°C

Hilti HIT-HY 200-A/R V3

		HY 200-A V3		HY 200-R V3	
		HIT-V, HAS-U, HAS, HAS-E		HIT-Z	
		Rebar		Barra de refuerzo	
[°C]	[°F]	$t_{trabajo}$	$t_{curado}$	$t_{trabajo}$	$t_{curado}$
-10...-5	14...23	1,5 h	7 h	⊘	⊘
-4...0	24...32	50 min	4 h	⊘	⊘
1...5	33...41	25 min	2 h	⊘	⊘
6...10	42...50	15 min	75 min	15 min	75 min
11...20	51...68	7 min	45 min	7 min	45 min
21...30	69...86	4 min	30 min	4 min	30 min
31...40	87...104	3 min	30 min	3 min	30 min

		HY 200-R V3		HIT-Z	
		Barra de refuerzo		Barra de refuerzo	
[°C]	[°F]	$t_{trabajo}$	$t_{curado}$	$t_{trabajo}$	$t_{curado}$
-10...-5	14...23	3 h	20 h	⊘	⊘
-4...0	23...32	90 min	8 h	⊘	⊘
1...5	32...41	45 min	4 h	⊘	⊘
6...10	41...50	30 min	2,5 h	30 min	2,5 h
11...20	50...68	15 min	1,5 h	15 min	1,5 h
21...30	69...86	9 min	1 h	9 min	1 h
31...40	87...104	6 min	1 h	6 min	1 h

$h_{ef}$ [inch]	$h_{ef}$ [mm]	$t_{desbaste\ máx}$	$t_{aplicado\ mín}$
0 ... 4	0 ... 100	10 sec	30 sec
4.01 ... 8	101 ... 200	20 sec	40 sec
8.01 ... 12	201 ... 300	30 sec	50 sec
12.01 ... 16	301 ... 400	40 sec	60 sec
16.01 ... 20	401 ... 500	50 sec	70 sec
20.01 ... 25	501 ... 600	60 sec	80 sec

$t_{desbaste[sec]} = h_{ef} [pulg.] / 2,5$        $t_{desbaste[sec]} = h_{ef} [mm] / 10$

3

Hilti HIT-HY 200-A/R V3

Fracional/Imperial

d [pulg]	Barra de refuerzo US		Barra de refuerzo CA		HIS-N, -RN		$T_{res}$ [lb·pulg]	$d_2$	$d_3$		
	HY 200-A V3	HY 200-R V3	HY 200-A V3	HY 200-R V3	d [pulg]	$h_{ef}$ [pulg]				$h_{ef}$ [pulg]	d [pulg]
#3	2 3/8 ... 22 1/2	3 3/8	10 M	70 ... 678					1/2		
#4	2 3/4 ... 30	4 1/2			3/8	4 3/8	4 3/8	7/16	3/8 ... 15 1/8	≤15	1 1/16
#5	3 1/8 ... 37 1/2	5 5/8	15 M	80 ... 960					3/4		3/4
#6	3 1/2 ... 15	6 3/4			1/2	5	5	9/16	1 1/2 ... 1 3/16	≤30	7/8
#7	3 1/2 ... 17 1/2		20 M	90 ... 390							1
#7	17 1/2 ... 52 1/2			90 ... 1170							1
#8	4 ... 20				5/8	6 3/4	11/16	5/8 ... 1 1/2	≤80	1 1/8	1 1/8
#8	20 ... 60		25 M	101 ... 504							1 1/4
#8	4 1/2 ... 22 1/2	4 1/2 ... 67 1/2		101 ... 1512	3/4	8 1/8	13/16	3/4 ... 1 7/8	≤100	1 1/4	1 1/4
#10	5 ... 25	5 ... 75	30 M	120 ... 598							1 1/2

Ø d <sub>1</sub> [pulg]	7/16	1/2	9/16	5/8	11/16	3/4	7/8	1	1 1/8	1 1/4	1 3/8	1 1/2
HIT-RB	7/16	1/2	9/16	5/8	11/16	3/4	7/8	1	1 1/8	1 1/4	1 3/8	1 1/2
HIT-SZ	-	1/2	9/16	5/8	11/16	3/4	7/8	1	1 1/8	1 1/4	1 3/8	1 1/2
HIT-DL	-	1/2	9/16	5/8	11/16	3/4	7/8	1	1	1	1 3/8	1 3/8
HIT-OHC	387551								387552			
TE-YRT	-	-	-	-	-	3/4	7/8	1	1 1/8	-	1 3/8	

HIT-DL:  $h_{ef} > 10"$       HIT-RB:  $h_{ef} > 20d$





4

FIGURA 6—INSTRUCCIONES DE INSTALACIÓN IMPRESAS DEL FABRICANTE (MPII)

**Fracional/Imperial Hilti HIT-HY 200-A/R V3**

● HAS / HAS-E / HIT-V						● HIT-Z, HIT-Z-R							
d [pulg]	$h_{ef}$ [pulg]	$h_{ef}$ [pulg]	$T_{res}$ [lb-pie]	$d_1$ [pulg]	$d_2$ [pulg]	d [pulg]	$h_{ef}$ [pulg]	$h_{ef}$ [pulg]	$T_{res}$ HIT-Z [lb-pie]	$T_{res}$ HIT-Z-R [lb-pie]	$d_1$ [pulg]	$d_2$ [pulg]	$d_3$ [pulg]
3/8	2 3/8 ... 7 1/2	3 3/8	≤15	1/2	7/16	3/8	2 3/8 ... 4 1/2	3 3/8	15	30	1/2	7/16	7/16
1/2	2 3/4 ... 10	4 1/2	≤30	5/8	9/16	1/2	2 3/4 ... 6	4 1/2	30	65	5/8	9/16	9/16
5/8	3 1/8 ... 12 1/2	5 5/8	≤80	13/16"	11/16"	5/8	3 3/4 ... 7 1/2	5 5/8	60	125	13/16"	11/16"	3/4
3/4	3 1/2 ... 15	6 3/4	≤100	15/16"	13/16"	3/4	4 ... 8 1/2	6 3/4	110	165	15/16"	13/16"	7/8
7/8	3 1/2 ... 17 1/2	6 3/4	≤125	1 1/8"	15/16"								1
1	4 ... 20	-	≤150	1 1/4"	1 1/8"								1 1/8
													1 1/4
													1 3/8
1/4	5 ... 25	-	≤200	1 1/2"	1 3/8"								1 1/2

HIT-RE-M	HIT-OHW
	
Art. No. 337111	Art. No. 387550

  

$d_1$ [pulg]	[pulg]	Art. No. 381215	
7/8" ... 1 1/8"	2 3/4" ... 20"	✓	≥ 6 bar/90 psi @ 6 m³/h
1 1/4" ... 1 1/2"	4" ... 25"	-	≥ 140 m³/h / ≥ 82 CFM

5

**Hilti HIT-HY 200-A/R V3**

**● Barra de refuerzo**

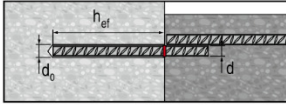

**● HIS-N, -RN**

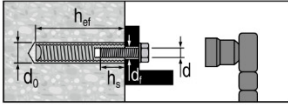

  

● Barra de refuerzo		● HIS-N, -RN				● HAS-U / HIT-V						
d [mm]	$h_{ef}$ [mm]	d [mm]	$h_{ef}$ [mm]	$d_1$ [mm]	$h_c$ [mm]	$T_{res}$ [Nm]	d [mm]	$h_{ef}$ [mm]	$T_{res}$ [Nm]	$d_1$ [mm]	$d_2$ [mm]	$d_3$ [mm]
8	60..480						M8	60-160	≤10	11	9	10
10	60..600	M8	90	9	8-20	≤10	M10	60-200	≤20	14	12	12
12	70...720						M12	70-240	≤40	16	14	14
14	75...1000	M10	110	12	10-25	≤20	M16	80-320	≤80	20*	18	18
16	80...1000						M20	90-400	≤150	24*	22	22
18	85...1000	M12	125	14	12-30	≤40	M24	96-480	≤200	30*	26	28
20	90...1000						M27	108-540	≤270	32*	30	30
22	95...1000	M16	170	18	16-40	≤80	M30	120-600	≤300	37*	33	35
24/25	96/100...1000	M20	205	22	20-50	≤150						
26/28	104/112...1000											
30	120...1000											
32	126...1000											

6

**Valores Métricos Hilti HIT-HY 200-A/R V3**

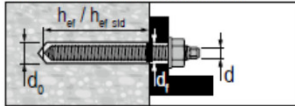
**● HAS-U / HIT-V / HAS / HAS-E**



**● HIT-Z, -R**

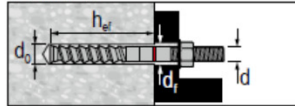

HIT-DL:  $h_w > 250\text{mm}$  HIT-RB:  $h_w > 20\text{d}$

● HIT-Z / HIT-Z-R											
d [mm]	$h_{res}$ [mm]	$T_{res}$ HIT-Z [Nm]	$T_{res}$ HIT-Z-R [Nm]	$d_1$ [mm]	$d_2$ [mm]	$d_3$ [mm]	HIT-RB	HIT-SZ	HIT-DL	HIT-OHC	TE-Y/RT
M8	60-96	10	30	11	9	10	10				
M10	60-120	25	55	14	12	12	12				
M12	60-144	40	75	16	14	14	14				
M16	96-192	80	155	20*	18	18	18			4307551	18
M20	100-220	150	215	24*	22	22	22			4307552	20
							25				25
							28				28
							30				30
							32				32
							35				35

7

**1**

HIT-Z

$d_1$ : 7/16" ... 7/8" ; 10 ... 22 mm  
 $h_w$ : 2 3/8" ... 8 1/2" ; 60 ... 220 mm

**2**

HIT-Z

$d_1$ : 7/16" ... 7/8" ; 10 ... 22 mm  
 $h_w$ : 2 3/8" ... 8 1/2" ; 60 ... 220 mm

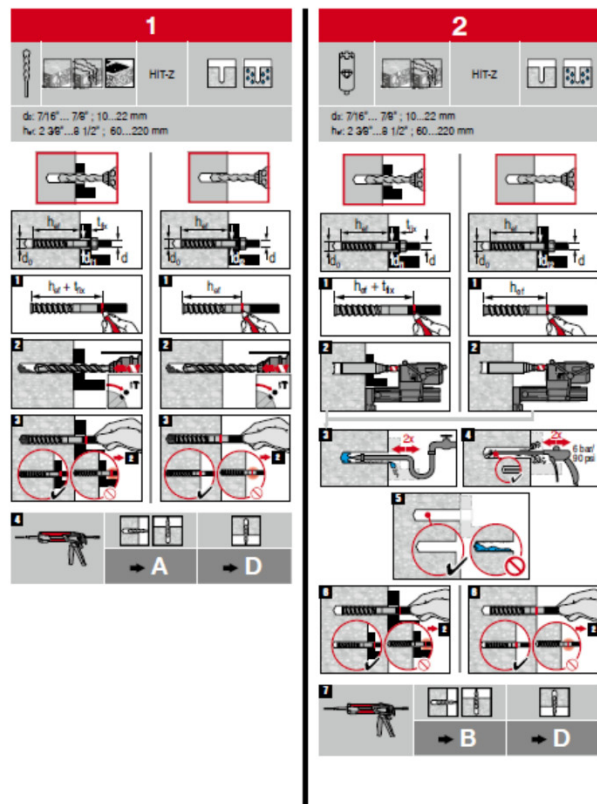

A → D

B → D

8

FIGURA 6—INSTRUCCIONES DE INSTALACIÓN IMPRESAS DEL FABRICANTE (MPII) (Continuación)

3

--	--	--	--	--

di: 7/16" ... 1 1/8" ... 10 ... 35 mm  
hv: 2 3/8" ... 39 3/8" ... 60 ... 1000 mm

TE-CD  
TE-YD  
VC 140  
VC 150  
VC 300  
ECO  
67

--	--	--	--

B C D

4

--	--	--	--

di: 7/16" ... 1 1/2" ... 10 ... 40 mm  
hv: 2 3/8" ... 75 1/2" ... 60 ... 1920 mm

--	--	--	--

B C D

5

--	--	--	--

di: 5/8" ... 1 1/4" ... 18 ... 35 mm  
hv: 3 1/8" ... 25" ... 80 ... 600 mm

--	--	--	--

B C D

6

--	--	--

di: 7/16" ... 1 3/4" ... 10 ... 40 mm  
hv: 2 3/8" ... 10" ... 250 mm

--	--	--

B C

A

--	--	--

di: 2 3/8" ... 9 1/2" ... 60 ... 220mm

--	--	--	--

B

B

--	--	--	--

di: 2 3/8" ... 9 7/8" ... 60 ... 250mm

--	--	--	--

B

9
10

C

--	--	--	--

di: 2 3/8" ... 75 1/2" ... 60 ... 1920mm

HIT-RE-M, HIT-SZ

--	--	--	--

B

D

--	--	--	--

di: 2 3/8" ... 75 1/2" ... 60 ... 1920mm

--	--	--	--

B

E

Resina de inyección para la fijación de anclajes y tacos en hormigón.

**Hilti HIT-HY 200-A/-R V3**

Contiene: metacrilato de hidroxipropilo (A), Dimetacrilato de 1,4-butanodiol (A), 2,2-(m-tolilmino)dielanol (A), peróxido de dibenziloilo (B)

Atención | Puede provocar una reacción alérgica en la piel. (A, B) | Provoca irritación ocular grave. (B) | Muy tóxico para los organismos acuáticos, con efectos nocivos duraderos. (B) | Evitar el contacto con los ojos, la piel o la ropa. | Llevar gafas de protección, prendas de protección, guantes de protección. | EN CASO DE CONTACTO CON LA PIEL: lavar con agua y jabón abundantes. | EN CASO DE CONTACTO CON LOS OJOS: aclarar cuidadosamente con agua durante varios minutos. Quitar las lentes de contacto, si lleva y resulta fácil. Seguir aclarando. | En caso de irritación o erupción cutánea: consultar a un médico. | Si persiste la irritación ocular: consultar a un médico.

**Indicaciones de reciclaje Cartuchos vacíos:** Deseche el mezclador enroscado a través del sistema de recogida nacional identificado como Punto Verde. O el código de residuo LER: 150102 embalajes de plástico **Cartuchos llenos o parcialmente vacíos:** Deberán eliminarse como residuos especiales de acuerdo con las normativas oficiales. Código de residuo LER: 08 04 09 Residuos de adhesivos y sellantes que contienen disolventes orgánicos u otras sustancias peligrosas. O el código de residuo LER: 20 01 27\* Pinturas, tintas, adhesivos y resinas que contienen sustancias peligrosas.

**Información del producto** Conserve las presentes instrucciones de uso siempre junto con el producto y entréguelas también si el producto pasa a manos de otra persona. Consulte la **hoja de datos de seguridad** antes de utilizar el producto. **La fecha de caducidad** se indica en la pieza de conexión (mes/año). El producto no debe utilizarse después de la fecha de caducidad. **Temperatura del cartucho durante la utilización:** de 0 °C a 40 °C / de 32 °F a 104 °F. **Temperatura del material base durante la instalación:** Varilla HAS-U, Varilla HIT-V, manguito HIS, barra corrugada: de -10 °C a 40 °C / de 14 °F a 104 °F. **HIT-Z:** de +5 °C a 40 °C / de 41 °F a 104 °F. **Condiciones de transporte y almacenamiento:** lugar fresco, seco y oscuro con una temperatura de +5 °C a 25 °C / de 41 °F a 77 °F. Para aplicaciones que no se describen en las presentes instrucciones de uso o no se marcan en la especificación, póngase en contacto con Hilti. **Los cartuchos que no están completamente vacíos deberán permanecer en el portacartuchos** y utilizarse antes de **cuatro semanas**. Para ello deberán guardarse en el portacartuchos con el mezclador enroscado en las condiciones de almacenamiento recomendadas. Antes de utilizarlo de nuevo, enroscar un nuevo mezclador y desechar la resina inicial.

La inobservancia de las instrucciones de instalación, el uso de anclajes que no sean Hilti, malas o dudosas condiciones del hormigón y/o aplicaciones inadecuadas pueden afectar la fiabilidad y respuesta de las fijaciones.

▲ AVISO

▲ La superficie de la barra de anclaje HIT-Z no debe modificarse.

▲ La rosca de HIT-Z debe permanecer libre de suciedad y polvo durante la instalación y los conos deben estar completamente incrustados en la resina (especialmente en profundidad mínima). Tuerca y arandela de HIT-Z deben ser siempre ajustados con el torque correspondiente, fijando la placa base al concreto

▲ La resina puede palpiciar si se utiliza incorrectamente. Lleve gafas protectoras, guantes de protección y ropa de trabajo durante el trabajo. ¡No comience a inyectar si no se ha roscado el mezclador. ¡Enrosque un nuevo mezclador antes de trabajar con un cartucho nuevo. Asegúrese de que el mezclador está unido firmemente. ¡Utilice exclusivamente el modelo de mezclador (HIT-RE-M) suministrado con la resina. ¡No modifique el mezclador en ningún caso. No utilice cartuchos en mal estado y/o portacartuchos dañados o sucios.

▲ Valores de sujeción deficientes/fallo de la fijación debido a limpieza insuficiente del taladro. Las brocas huecas TE-CD, TE-YD de Hilti deben utilizarse con una aspiradora de Hilti en buen estado de funcionamiento del modelo y la capacidad de succión (tasa de flujo volumétrico) que se especifican en la tabla de accesorios. ¡Antes de inyectar la resina, los taladros deben estar libres de restos de perforación, polvo, agua, hielo, aceite, grasa o cualquier otro agente contaminante. ¡Soplado del taladro con aire sin aceite hasta que el aire que refuye esté libre de polvo. ¡Lavado del taladro: lave con una manguera de agua con la presión normal de la red hasta que salga agua limpia. ¡Limpieza del taladro: realícese sólo con un cepillo metálico de tamaño apropiado. Al cepillar el taladro, se notará cierta resistencia en el cepillo. Si no es este el caso, el cepillo es demasiado pequeño y debe cambiarse. ¡Atención! Antes de añadir la resina es necesario extraer el agua del taladro y limpiar el taladro con aire a presión sin aceite hasta que quede completamente seco. ¡A la hora de raspar el taladro, no superar el tiempo de raspado.

▲ Verificar que el relleno del taladro se produce desde el fondo del taladro para que no se formen burbujas de aire. Si es necesario, utilice las prolongaciones para alcanzar el fondo del taladro. ¡En aplicaciones por encima de la cabeza, utilice el accesorio HIT-SZ y preste especial atención al introducir el elemento de fijación. Puede salir resina sobrante del taladro. Asegúrese de que la resina no gotee sobre el usuario. ¡En el hormigón saturado de agua es necesario colocar el anclaje inmediatamente después de limpiar el taladro.

▲ El incumplimiento de estas instrucciones puede llevar a una fijación incorrecta.

11

FIGURA 6—INSTRUCCIONES DE INSTALACIÓN IMPRESAS DEL FABRICANTE (MPII) (Continuación)

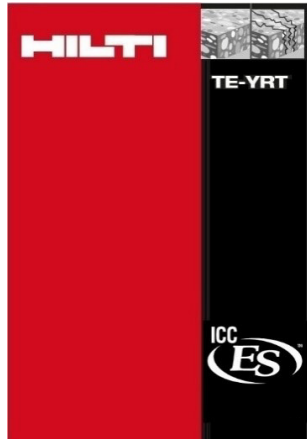

4.1	HILTI	Ø d <sub>0</sub> [mm]	TE-YRT
		18	TE-YRT 18/320
		20	TE-YRT 20/320
		22	TE-YRT 22/400
		25	TE-YRT 25/400
		28	TE-YRT 28/480
		30	TE-YRT 30/540
		32	TE-YRT 32/500
		35	TE-YRT 35/600
	HILTI	Ø d <sub>0</sub> [pulg.]	TE-YRT
		3/4"	TE-YRT 3/4" / 12 1/2"
		7/8"	TE-YRT 7/8" / 15"
		1"	TE-YRT 1" / 17 1/2"
		1 1/8"	TE-YRT 1 1/8" / 20"
		1 3/8"	TE-YRT 1 3/8" / 25"

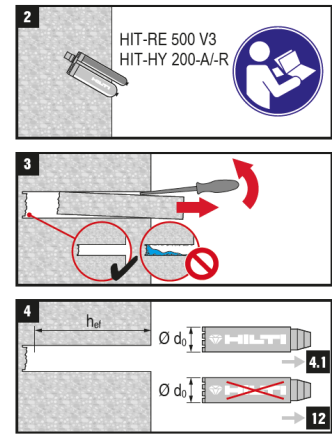
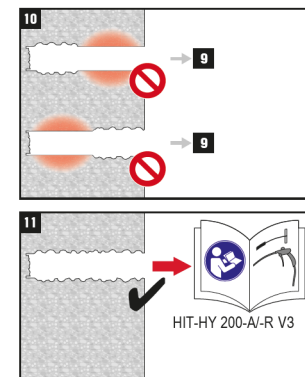
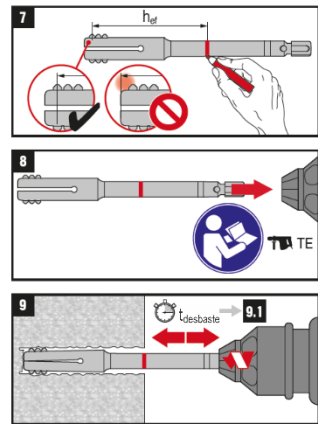
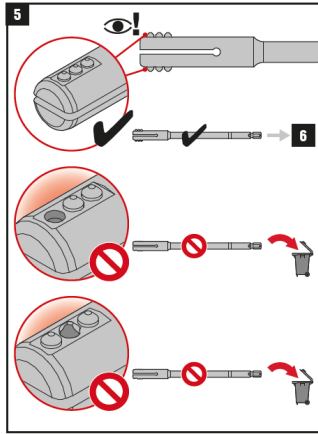
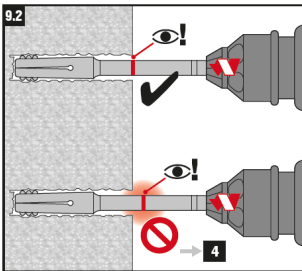
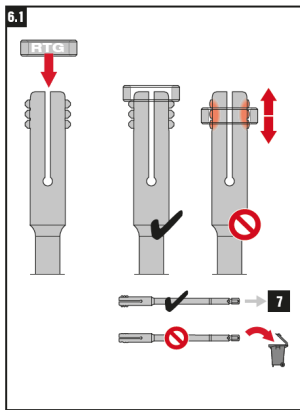

6	TE-YRT	(i) RTG
	TE-YRT 18/320	RTG 18
	TE-YRT 20/320	RTG 20
	TE-YRT 22/400	RTG 22
	TE-YRT 25/400	RTG 25
	TE-YRT 28/480	RTG 28
	TE-YRT 30/540	RTG 30
	TE-YRT 32/500	RTG 32
	TE-YRT 35/600	RTG 35
	TE-YRT	(i) RTG
	TE-YRT 3/4" / 12 1/2"	RTG 3/4"
	TE-YRT 7/8" / 15"	RTG 7/8"
	TE-YRT 1" / 17 1/2"	RTG 1"
	TE-YRT 1 1/8" / 20"	RTG 1 1/8"
	TE-YRT 1 3/8" / 25"	RTG 1 3/8"

9.1	h <sub>ref</sub> [mm]	t <sub>desbaste</sub> (= h <sub>ref</sub> / 10)
	0 ... 100	10 sec
	101 ... 200	20 sec
	201 ... 300	30 sec
	301 ... 400	40 sec
	401 ... 500	50 sec
	501 ... 600	60 sec
	h <sub>ref</sub> [pulg.]	t <sub>desbaste</sub> (= h <sub>ref</sub> · 2.5)
	0 ... 4	10 sec
	4.01 ... 8	20 sec
	8.01 ... 12	30 sec
	12.01 ... 16	40 sec
	16.01 ... 20	50 sec
	20.01 ... 25	60 sec

12	Ø d <sub>0</sub> [mm]	TE-YRT
	17.9 ... 18.2	TE-YRT 18/320
	19.9 ... 20.2	TE-YRT 20/320
	21.9 ... 22.2	TE-YRT 22/400
	24.9 ... 25.2	TE-YRT 25/400
	27.9 ... 28.2	TE-YRT 28/480
	29.9 ... 30.2	TE-YRT 30/540
	31.9 ... 32.2	TE-YRT 32/500
	34.9 ... 35.2	TE-YRT 35/600
	Ø d <sub>0</sub> [pulg.]	TE-YRT
	0.764 ... 0.776	TE-YRT 3/4" / 12 1/2"
	0.862 ... 0.874	TE-YRT 7/8" / 15"
	1.008 ... 1.020	TE-YRT 1" / 17 1/2"
	1.146 ... 1.157	TE-YRT 1 1/8" / 20"
	1.374 ... 1.386	TE-YRT 1 3/8" / 25"

FIGURA 6— INSTRUCCIONES DE INSTALACIÓN IMPRESAS DEL FABRICANTE (MPII)  
(Continuación)



**DIVISION: 03 00 00—CONCRETE**

Section: 03 16 00—Concrete Anchors

**DIVISION: 05 00 00—METALS**

Section: 05 05 19—Post-installed Concrete Anchors

**REPORT HOLDER:**

HILTI, INC.

**EVALUATION SUBJECT:**

**HILTI HIT-HY 200 V3 ADHESIVE ANCHORS AND POST INSTALLED REINFORCING BAR CONNECTIONS IN CONCRETE**

### 1.0 EVALUATION SCOPE

**Compliance with the following codes:**

- 2021, 2018, 2015, and 2012 *International Building Code*® (IBC)
- 2021, 2018, 2015, and 2012 *International Residential Code*® (IRC)

For evaluation for compliance with codes adopted by the Los Angeles Department of Building and Safety (LADBS), see [ESR-4868 LABC and LARC Supplement](#).

**Property evaluated:**

Structural

### 2.0 USES

Adhesive anchors and reinforcing bars installed using the Hilti HIT-HY 200 V3 Adhesive Anchoring System and Post-Installed Reinforcing Bar System are used to resist static, wind and earthquake (Seismic Design Categories A through F) tension and shear loads in cracked and uncracked normal-weight or lightweight concrete having a specified compressive strength,  $f'_c$ , of 2,500 psi to 8,500 psi (17.2 MPa to 58.6 MPa).

The anchor system complies with anchors as described in Section 1901.3 of the 2021, 2018 and 2015 IBC, and Section 1909 of the 2012 IBC and is an alternative to cast-in-place anchors described in Section 1908 of the 2012 IBC. The anchor systems may also be used where an engineered design is submitted in accordance with Section R301.1.3 of the IRC.

The post-installed reinforcing bar system is an alternative to cast-in-place reinforcing bars governed by ACI 318 and IBC Chapter 19.

### 3.0 DESCRIPTION

#### 3.1 General:

The Hilti HIT-HY 200 V3 Adhesive Anchoring System and Post-Installed Reinforcing Bar System are comprised of the following components:

- Hilti HIT-HY 200 V3 adhesive packaged in foil packs (either Hilti HIT-HY 200-A V3 or Hilti HIT-HY 200-R V3)
- Adhesive mixing and dispensing equipment
- Equipment for hole cleaning and adhesive injection

The Hilti HIT-HY 200 V3 Adhesive Anchoring System may be used with continuously threaded rod, Hilti HIT-Z(-R) anchor rods, Hilti HIS-(R)N internally threaded inserts or deformed steel reinforcing bars as depicted in Figure 1. The Hilti HIT-HY 200 V3 Post-Installed Reinforcing Bar System may only be used with deformed steel reinforcing bars as depicted in Figure 2. The primary components of the Hilti Adhesive Anchoring and Post-Installed Reinforcing Bar Systems, including the Hilti HIT-HY 200 V3 Adhesive, HIT-RE-M static mixing nozzle and steel anchoring elements, are shown in Figure 5 of this report.

The manufacturer's printed Installation instructions (MPII), as included with each adhesive unit package, are replicated as Figure 6.

#### 3.2 Materials:

**3.2.1 Hilti HIT-HY 200 V3 Adhesive:** Hilti HIT-HY 200 V3 Adhesive is an injectable, two-component hybrid adhesive. The two components are separated by means of a dual-cylinder foil pack attached to a manifold. The two components combine and react when dispensed through a static mixing nozzle attached to the manifold. Hilti HIT-HY 200 V3 is available in 11.1-ounce (330 mL) and 16.9-ounce (500 mL) foil packs. The manifold attached to each foil pack is stamped with the adhesive expiration date. The shelf life, as indicated by the expiration date, applies to an unopened foil pack stored in a dry, dark environment and in accordance with Figure 6.

Hilti HIT-HY 200 V3 Adhesive is available in two options, Hilti HIT-HY 200-A V3 and Hilti HIT-HY 200-R V3. Both options are subject to the same technical data as set forth in this report. Hilti HIT-HY 200-A V3 will have shorter working times and curing times than Hilti HIT-HY 200-R V3. The packaging for each option employs a different color, which helps the user distinguish between the two adhesives.

#### 3.2.2 Hole Cleaning Equipment:

**3.2.2.1 Standard Equipment:** Standard hole cleaning equipment, comprised of steel wire brushes and air nozzles, is described in Figure 6 of this report.

**3.2.2.2 Hilti Safe-Set™ System:** The Hilti Safe-Set™ with Hilti HIT-HY 200 V3 consists of one of the following:

- For the Hilti HIT-Z and HIT-Z-R anchor rods, hole cleaning is not required after drilling the hole, except if the hole is drilled with a diamond core drill bit.
- For the elements described in Sections 3.2.4.2 through 3.2.4.4 and Section 3.2.5, the Hilti TE-CD or TE-YD hollow carbide drill bit with a carbide drilling head conforming to ANSI B212.15. Used in conjunction with a Hilti vacuum with a minimum value for the maximum volumetric flow rate of 129 CFM (61 *ℓ*/s), the Hilti TE-CD or TE-YD drill bit will remove the drilling dust, automatically cleaning the hole.

### 3.2.3 Hole Preparation Equipment:

**3.2.3.1 Hilti Safe-Set™ System: TE-YRT Roughening Tool:** For the elements described in Sections 3.2.5.2 through 3.2.5.4 and Tables 12, 13, 15, 18, 19, 21, 24, 25, 28 and 29, the Hilti TE-YRT roughening tool with a carbide roughening head is used for hole preparation in conjunction with holes core drilled with a diamond core bit as illustrated in Section 4.1.4.2 of this report.

**3.2.4 Dispensers:** Hilti HIT-HY 200 V3 must be dispensed with manual or electric dispensers provided by Hilti.

### 3.2.5 Anchor Elements:

**3.2.5.1 Hilti HIT-Z and HIT-Z-R Anchor Rods:** Hilti HIT-Z and HIT-Z-R anchor rods have a conical shape on the embedded section and a threaded section above the concrete surface. Mechanical properties for the Hilti HIT-Z and HIT-Z-R anchor rods are provided in Table 2. The rods are available in diameters as shown in Table 7 and Figure 1. Hilti HIT-Z anchor rods are produced from carbon steel and furnished with a 0.005-millimeter-thick (5  $\mu$ m) zinc electroplated coating. Hilti HIT-Z-R anchor rods are fabricated from grade 316 stainless steel.

**3.2.5.2 Threaded Steel Rods:** Threaded steel rods must be clean, continuously threaded rods (all-thread) in diameters as described in Tables 11 and 17 and Figure 1 of this report. Steel design information for common grades of threaded rods is provided in Table 3. Carbon steel threaded rods may be furnished with a 0.0002-inch-thick (0.005 mm) zinc electroplated coating complying with ASTM B633 SC 1 or must be hot-dipped galvanized complying with ASTM A153, Class C or D. Stainless steel threaded rods must comply with ASTM F593 or ISO 3506 A4. Threaded steel rods must be straight and free of indentations or other defects along their length. The ends may be stamped with identifying marks and the embedded end may be blunt cut or cut on the bias to a chisel point.

**3.2.5.3 Steel Reinforcing Bars for use in Post-Installed Anchor Applications:** Steel reinforcing bars are deformed bars as described in Table 4 of this report. Tables 11A, 17, and 23 and Figure 1 summarize reinforcing bar size ranges. The embedded portions of reinforcing bars must be straight, and free of mill scale, rust, mud, oil and other coatings (other than zinc) that may impair the bond with the adhesive. Reinforcing bars must not be bent after installation except as set forth in ACI 318-19 Section 26.6.3.2(b) ACI 318-14 Section 26.6.3.1(b) or ACI 318-11 Section 7.3.2, as applicable, with the additional condition that the bars must be bent cold, and heating of reinforcing bars to facilitate field bending is not permitted.

**3.2.5.4 Hilti HIS-N and HIS-RN Inserts:** Hilti HIS-N and HIS-RN inserts have a profile on the external surface and are internally threaded. Mechanical properties for Hilti HIS-N and HIS-RN inserts are provided in Table 5. The inserts are available in diameters and lengths as shown in Table 27 and

Figure 1. Hilti HIS-N inserts are produced from carbon steel and furnished with a 0.005-millimeter-thick (5  $\mu$ m) zinc electroplated coating complying with ASTM B633 SC 1. The stainless steel Hilti HIS-RN inserts are fabricated from X5CrNiMo17122 K700 steel conforming to DIN 17440. Specifications for common bolt types that may be used in conjunction with Hilti HIS-N and HIS-RN inserts are provided in Table 6. Bolt grade and material type (carbon, stainless) must be matched to the insert. Strength reduction factors,  $\phi$ , corresponding to brittle steel elements must be used for Hilti HIS-N and HIS-RN inserts.

**3.2.5.5 Ductility:** In accordance with ACI 318-19 and ACI 318-14 2.3 or ACI 318-11 D.1, as applicable, in order for a steel element to be considered ductile, the tested elongation must be at least 14 percent and reduction of area must be at least 30 percent. Steel elements with a tested elongation of less than 14 percent or a reduction of area of less than 30 percent, or both, are considered brittle. Values for various steel materials are provided in Tables 2, 3, and 6 of this report. Where values are nonconforming or unstated, the steel must be considered brittle.

**3.2.6 Steel Reinforcing Bars for Use in Post-Installed Reinforcing Bar Connections:** Steel reinforcing bars used in post-installed reinforcing bar connections are deformed bars (rebar) as depicted in Figures 2 and 3. Tables 30, 31, 32, and Figure 6 summarize reinforcing bar size ranges. The embedded portions of reinforcing bars must be straight, and free of mill scale, rust and other coatings that may impair the bond with the adhesive. Reinforcing bars must not be bent after installation, except as set forth in Section 26.6.3.2(b) of ACI 318-19, Section 26.6.3.1(b) of ACI 318-14 or Section 7.3.2 of ACI 318-11, as applicable, with the additional condition that the bars must be bent cold, and heating of reinforcing bars to facilitate field bending is not permitted.

### 3.3 Concrete:

Normal-weight and lightweight concrete must comply with Sections 1903 and 1905 of the IBC, as applicable. The specified compressive strength of the concrete must be from 2,500 psi to 8,500 psi (17.2 MPa to 58.6 MPa).

## 4.0 DESIGN AND INSTALLATION

### 4.1 Strength Design of Post-Installed Anchors:

Refer to Table 1 for the design parameters for specific installed elements, and refer to Section 4.1.4.2 for a table to determine the applicable design bond strength or pullout strength.

**4.1.1 General:** The design strength of anchors under the 2021 IBC, as well as the 2021 IRC, must be determined in accordance with ACI 318-19 and this report. The design strength of anchors under the 2018 and 2015 IBC and 2018 and 2015 IRC must be determined in accordance with ACI 318-14 and this report. The design strength of anchors under the 2012 IBC, as well as the 2012 IRC must be determined in accordance with ACI 318-11 and this report.

Design parameters are based on ACI 318-19 for use with the 2021 IBC, ACI 318-14 for use with the 2018 and 2015 IBC, and ACI 318-11 for use with the 2012 IBC unless noted otherwise in Sections 4.1.1 through 4.1.11 of this report.

The strength design of anchors must comply with ACI 318-19 17.5.1.2 or ACI 318-14 17.3.1 or ACI 318-11 D.4.1 as applicable, except as required in ACI 318-19 17.10 or ACI 318-14 17.2.3 or ACI 318-11 D.3.3, as applicable.

Design parameters are provided in Table 7 through Table 29. Strength reduction factors,  $\phi$ , as given in ACI 318-19 17.5.3, ACI 318-14 17.3.3 or ACI 318-11 D.4.3, as applicable must be used for load combinations calculated in accordance with Section 1605.1 of the 2021 IBC or Section

1605.2 of the 2018, 2015 and 2012 IBC or ACI 318-19 and ACI 318-14 5.3 or ACI 318-11 9.2, as applicable. Strength reduction factors,  $\phi$ , as given in ACI 318-11 D.4.4 must be used for load combinations calculated in accordance with ACI 318-11 Appendix C.

**4.1.2 Static Steel Strength in Tension: The nominal static steel strength of a single anchor in tension,  $N_{sa}$ , in accordance with ACI 318-19 17.6.1.2, ACI 318-14 17.4.1.2 or ACI 318-11 Section D.5.1.2, as applicable and the associated strength reduction factors,  $\phi$ , in accordance with ACI 318-19 17.5.3, ACI 318-14 17.3.3 or ACI 318-11 Section D.4.3, as applicable, are provided in the tables outlined in Table 1 for the anchor element types included in this report.**

**4.1.3 Static Concrete Breakout Strength in Tension:** The nominal concrete breakout strength of a single anchor or group of anchors in tension,  $N_{cb}$  or  $N_{cbg}$ , must be calculated in accordance with ACI 318-19 17.6.2, ACI 318-14 17.4.2 or ACI 318-11 D.5.2, as applicable, with the following addition:

The basic concrete breakout strength of a single anchor in tension,  $N_b$ , must be calculated in accordance with ACI 318-19 17.6.2.2, ACI 318-14 17.4.2.2 or ACI 318-11 D.5.2.2, as applicable using the values of  $k_{c,cr}$  and  $k_{c,uncr}$  as described in this report. Where analysis indicates no cracking in accordance with ACI 318-19 17.6.2.5, ACI 318-14 17.4.2.6 or ACI 318-11 D.5.2.6, as applicable,  $N_b$  must be calculated using  $k_{c,uncr}$  and  $\Psi_{c,N} = 1.0$ . See Table 1. For anchors in lightweight concrete, see ACI 318-19 17.2.4, ACI 318-14 17.2.6 or ACI 318-11 D.3.6, as applicable. The value of  $f'_c$  used for calculation must be limited to 8,000 psi (55 MPa) in accordance with ACI 318-19 17.3.1, ACI 318-14 17.2.7 or ACI 318-11 D.3.7, as applicable. Additional information for the determination of nominal bond strength in tension is given in Section 4.1.4 of this report.

**4.1.4 Static Bond Strength/Static Pullout Strength in Tension:**

**4.1.4.1 Static Pullout Strength In Tension: Hilti HIT-Z and HIT-Z-R Anchor Rods:** The nominal static pullout strength of a single anchor in accordance with ACI 318-19 17.6.3.1 and 17.6.3.2.1, ACI 318-14 17.4.3.1 and 17.4.3.2 or ACI 318-11 D.5.3.1 and D.5.3.2, as applicable, in cracked and uncracked concrete,  $N_{p,cr}$  and  $N_{p,uncr}$ , respectively, is given in Table 10. For all design cases  $\Psi_{c,P} = 1.0$ .

Pullout strength values are a function of the concrete compressive strength, whether the concrete is cracked or uncracked, the drilling method (hammer drill, including Hilti hollow drill bit, diamond core drill) and installation conditions (dry or water-saturated). The resulting characteristic pullout strength must be multiplied by the associated strength reduction factor  $\phi_{nn}$  as follows:

HILTI HIT-Z AND HIT-Z-R THREADED RODS				
DRILLING METHOD	CONCRETE TYPE	PERMISSIBLE INSTALLATION CONDITIONS	PULLOUT STRENGTH	ASSOCIATED STRENGTH REDUCTION FACTOR
Hammer-drill (or Hilti TE-CD or TE-YD Hollow Drill Bit) or Diamond Core Bit	Uncracked	Dry	$N_{p,uncr}$	$\phi_d$
		Water saturated	$N_{p,uncr}$	$\phi_{ws}$
	Cracked	Dry	$N_{p,cr}$	$\phi_d$
		Water saturated	$N_{p,cr}$	$\phi_{ws}$

Section 4.1.4.2 of this report presents a pullout strength design selection table. Strength reduction factors for determination of the bond strength are given in the tables referenced in Table 1 of this report.

**4.1.4.2 Static Bond Strength in Tension: Threaded Rod, Steel Reinforcing Bars, and Hilti HIS-N and HIS-RN Inserts:** The nominal static bond strength of a single adhesive anchor or group of adhesive anchors in tension,  $N_a$  or  $N_{ag}$ , must be calculated in accordance with ACI 318-19 17.6.5, ACI 318-14 17.4.5 or ACI 318-11 D.5.5, as applicable. Bond strength values are a function of the concrete compressive strength, whether the concrete is cracked or uncracked, the concrete temperature range, and the installation conditions (dry or water-saturated concrete). The resulting characteristic bond strength shall be multiplied by the associated strength reduction factor  $\phi_{nn}$  as follows:

DRILLING METHOD	CONCRETE TYPE	PERMISSIBLE INSTALLATION CONDITIONS	BOND STRENGTH	ASSOCIATED STRENGTH REDUCTION FACTOR
Hammer-drill (or Hilti TE-CD or TE-YD Hollow Drill Bit) or Diamond Core Bit with Hilti TE-YRT roughening tool	Uncracked	Dry	$\tau_{k,uncr}$	$\phi_d$
		Water saturated	$\tau_{k,uncr}$	$\phi_{ws}$
	Cracked	Dry	$\tau_{k,cr}$	$\phi_d$
		Water saturated	$\tau_{k,cr}$	$\phi_{ws}$
Hammer-drill (or Hilti TE-CD or TE-YD Hollow Drill Bit)	Uncracked	Water-filled	$\tau_{k,uncr}$	$\phi_{wf}$
	Cracked		$\tau_{k,cr}$	$\phi_{wf}$

Strength reduction factors for determination of the bond strength are outlined in Table 1 of this report. Adjustments to the bond strength may also be made for increased concrete compressive strength as noted in the footnotes to the bond strength tables. For anchors in lightweight concrete see ACI 318-19 17.2.4, ACI 318-14 17.2.6, or ACI 318-11 D.3.6, as applicable.

**4.1.5 Static Steel Strength in Shear:** The nominal static strength of a single anchor in shear as governed by the steel,  $V_{sa}$ , in accordance with ACI 318-19 17.7.1.2, ACI 318-14 17.5.1.2 or ACI 318-11 D.6.1.2, as applicable and strength reduction factors,  $\phi$ , in accordance with ACI 318-19 17.5.3, ACI 318-14 17.3.3 or ACI 318-11 D.4.3, as applicable, are given in the tables outlined in Table 1 for the anchor element types included in this report.

**4.1.6 Static Concrete Breakout Strength in Shear:** The nominal static concrete breakout strength of a single anchor or group of anchors in shear,  $V_{cb}$  or  $V_{cbg}$ , must be calculated in accordance with ACI 318-19 17.7.2, ACI 318-14 17.5.2 or ACI 318-11 D.6.2, as applicable, based on information given in the tables outlined in Table 1. The basic concrete breakout strength of a single anchor in shear,  $V_b$ , must be calculated in accordance with ACI 318-19 17.7.2.2, ACI 318-14 17.5.2.2 or ACI 318-11 D.6.2.2, as applicable, using the values of  $d$  given in the tables as outlined in Table 1 for the corresponding anchor steel in lieu of  $d_a$  (2021, 2018, 2015, and 2012 IBC). In addition,  $h_{ef}$  must be substituted for  $\ell_e$ . In no case must  $\ell_e$  exceed  $8d$ . The value of  $f'_c$  must be limited to a maximum of 8,000 psi (55 MPa) in accordance with ACI 318-19 17.3.1, ACI 318-14 17.2.7 or ACI 318-11 D.3.7, as applicable.

**4.1.7 Static Concrete Pryout Strength in Shear:** The nominal static pryout strength of a single anchor or group of anchors in shear,  $V_{cp}$  or  $V_{cpg}$ , must be calculated in accordance with ACI 318-19 17.7.3, ACI 318-14 17.5.3 or ACI 318-11 D.6.3, as applicable.



**4.1.8 Interaction of Tensile and Shear Forces:** For designs that include combined tension and shear, the interaction of tension and shear loads must be calculated in accordance with ACI 318-19 17.8, ACI 318-14 17.6 or ACI 318-11 D.7, as applicable.

**4.1.9 Minimum Member Thickness,  $h_{min}$ , Anchor Spacing,  $s_{min}$  and Edge Distance,  $c_{min}$ :**

**4.1.9.1 Hilti HIT-Z and HIT-Z-R Anchor Rods:** In lieu of ACI 318-19 17.9.2, ACI 318-14 17.7.1 and 17.7.3 or ACI 318-11 D.8.1 and D.8.3, as applicable, values of  $s_{min}$  and  $c_{min}$  described in Table 9 of this report must be observed for anchor design and installation. The minimum member thicknesses,  $h_{min}$ , given in Table 9 of this report must be observed for anchor design and installation.

**4.1.9.2 Threaded Rod, Steel Reinforcing Bars, and Hilti HIS-N and HIS-RN Inserts:** In lieu of ACI 318-19 17.9.2, ACI 318-14 17.7.1 and 17.7.3 or ACI 318-11 D.8.1 and D.8.3, as applicable, values of  $c_{min}$  and  $s_{min}$  described in this report must be observed for anchor design and installation. Likewise, in lieu of ACI 318-19 17.9.4, ACI 318-14 17.7.5 or ACI 318-11 D.8.5, as applicable, the minimum member thicknesses,  $h_{min}$ , described in this report must be observed for anchor design and installation. For adhesive anchors that will remain untorqued, ACI 318-19 17.9.3, ACI 318-14 17.7.4 or ACI 318-11 D.8.4, as applicable, applies.

For edge distances  $c_{ai}$  and anchor spacing  $s_{ai}$ , the maximum torque  $T_{max}$  shall comply with the following requirements:

REDUCED MAXIMUM INSTALLATION TORQUE $T_{max,red}$ FOR EDGE DISTANCES $c_{ai} < (5 \times d_a)$		
EDGE DISTANCE, $c_{ai}$	MINIMUM ANCHOR SPACING, $s_{ai}$	MAXIMUM TORQUE, $T_{max,red}$
1.75 in. (45 mm) $\leq c_{ai} < 5 \times d_a$	$5 \times d_a \leq s_{ai} < 16$ in.	$0.3 \times T_{max}$
	$s_{ai} \geq 16$ in. (406 mm)	$0.5 \times T_{max}$

**4.1.10 Critical Edge Distance  $c_{ac}$  and  $\psi_{cp,Na}$ :**

**4.1.10.1 Hilti HIT-Z and HIT-Z-R Anchor Rods:** In lieu of ACI 318-19 17.9.5, ACI 318-14 17.7.6 or ACI 318-11 D.8.6, as applicable, for the calculation of  $N_{cb}$  and  $N_{cbg}$  in accordance with ACI 318-19 17.6.2.6.1, ACI 318-14 17.4.2.7 or ACI 318-11 D.5.2.7, as applicable and Section 4.1.3 of this report, the critical edge distance,  $c_{ac}$ , must be determined as follows:

- i.  $c_{ac} = 1.5 \cdot h_{ef}$  for  $h/h_{ef} \geq 2.35$
- ii.  $c_{ac} = 3.5 \cdot h_{ef}$  for  $h/h_{ef} \leq 1.35$

For definitions of  $h$  and  $h_{ef}$ , see Figure 1.

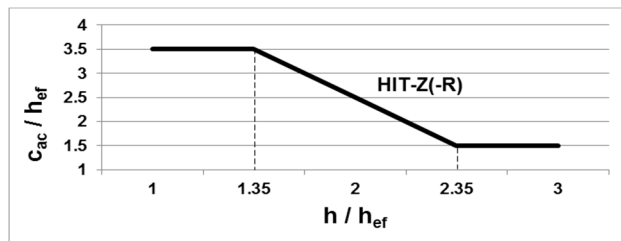

Linear interpolation is permitted to determine the ratio of  $c_{ac}/h_{ef}$  for values of  $h/h_{ef}$  between 2.35 and 1.35 as illustrated in the graph above.

**4.1.10.2 Threaded Rod, Steel Reinforcing Bars, and Hilti HIS-N and HIS-RN Inserts:** The modification factor  $\psi_{cp,Na}$ , must be determined in accordance with ACI 318-19 17.6.5.5, ACI 318-14 17.4.5.5 or ACI 318-11 D.5.5.5, as applicable, except as noted below:

For all cases where  $c_{Na}/c_{ac} < 1.0$ ,  $\psi_{cp,Na}$  determined from ACI 318-19 Eq. 17.6.5.5.1b, ACI 318-14 Eq. 17.4.5.5b or

ACI 318-11 Eq. D-27, as applicable, need not be taken less than  $c_{Na}/c_{ac}$ . For all other cases,  $\psi_{cp,Na}$  shall be taken as 1.0.

The critical edge distance,  $c_{ac}$  must be calculated according Eq. 17.6.5.5.1c for ACI 318-19, to Eq. 17.4.5.5c for ACI 318-14 or Eq. D-27a for ACI 318-11, in lieu of ACI 318-19 17.9.5, ACI 318-14 17.7.6 or ACI 318-11 D.8.6, as applicable.

$$c_{ac} = h_{ef} \cdot \left( \frac{\tau_{k,uncr}}{1160} \right)^{0.4} \cdot \left[ 3.1 - 0.7 \frac{h}{h_{ef}} \right]$$

(Eq. 17.6.5.5.1c for ACI 318-19, Eq. 17.4.5.5c for ACI 318-14 or Eq. D-27a for ACI 318-11)

where

$\left[ \frac{h}{h_{ef}} \right]$  need not be taken as larger than 2.4; and

$\tau_{k,uncr}$  is the characteristic bond strength in uncracked concrete,  $h$  is the member thickness, and  $h_{ef}$  is the embedment depth.

$\tau_{k,uncr}$  need not be taken as greater than:

$$\tau_{k,uncr} = \frac{k_{uncr} \sqrt{h_{ef}^2 c}}{\pi d} \quad \text{Eq. (4-1)}$$

**4.1.11 Design Strength in Seismic Design Categories C, D, E and F:** In structures assigned to Seismic Design Category C, D, E or F under the IBC or IRC, anchors must be designed in accordance with ACI 318-19 17.10, ACI 318-14 17.2.3 or ACI 318-11 D.3.3, as applicable, except as described below:

Modifications to ACI 318-19 17.10 and ACI 318-14 17.2.3 shall be applied under Section 1905.1.8 of the 2021, 2018 and 2015 IBC, as applicable. For the 2012 IBC, Section 19.5.1.9 shall be omitted. The nominal steel shear strength,  $V_{sa}$ , must be adjusted by  $\alpha_{V,seis}$  as given in the tables summarized in Table 1 for the anchor element types included in this report. For tension, the nominal pullout strength  $N_{p,cr}$  or bond strength  $\tau_{cr}$  must be adjusted by  $\alpha_{N,seis}$ . See Tables 10, 13, 14, 15, 16, 19, 20, 21, 22, 25, 26 and 29.

As an exception to ACI 318-11 D.3.3.4.2:

Anchors designed to resist wall out-of-plane forces with design strengths equal to or greater than the force determined in accordance with ASCE 7 Equation 12.11-1 or 12.14-10 shall be deemed to satisfy ACI 318-11 D.3.3.4.3(d). Under ACI 318-11 D.3.3.4.3(d), in lieu of requiring the anchor design tensile strength to satisfy the tensile strength requirements of ACI 318-11 D.4.1.1, the anchor design tensile strength shall be calculated from ACI 318-11 D.3.3.4.4.

The following exceptions apply to ACI 318-11 D.3.3.5.2:

1. For the calculation of the in-plane shear strength of anchor bolts attaching wood sill plates of bearing or non-bearing walls of light-frame wood structures to foundations or foundation stem walls, the in-plane shear strength in accordance with ACI 318-11 D.6.2 and D.6.3 need not be computed and ACI 318-11 D.3.3.5.3 need not apply provided all of the following are satisfied:

- 1.1. The allowable in-plane shear strength of the anchor is determined in accordance with AF&PA NDS Table 11E for lateral design values parallel to grain.
- 1.2. The maximum anchor nominal diameter is  $5/8$  inch (16 mm).
- 1.3. Anchor bolts are embedded into concrete a minimum of 7 inches (178 mm).
- 1.4. Anchor bolts are located a minimum of  $1 3/4$  inches (45 mm) from the edge of the concrete parallel to the length of the wood sill plate.

1.5. Anchor bolts are located a minimum of 15 anchor diameters from the edge of the concrete perpendicular to the length of the wood sill plate.

1.6. The sill plate is 2-inch or 3-inch nominal thickness.

2. For the calculation of the in-plane shear strength of anchor bolts attaching cold-formed steel track of bearing or non-bearing walls of light-frame construction to foundations or foundation stem walls, the in-plane shear strength in accordance with ACI 318-11 D.6.2 and D.6.3, need not be computed and ACI 318-11 D.3.3.5.3 need not apply provided all of the following are satisfied:

2.1. The maximum anchor nominal diameter is  $5/8$  inch (16 mm).

2.2. Anchors are embedded into concrete a minimum of 7 inches (178 mm).

2.3. Anchors are located a minimum of  $1\ 3/4$  inches (45 mm) from the edge of the concrete parallel to the length of the track.

2.4. Anchors are located a minimum of 15 anchor diameters from the edge of the concrete perpendicular to the length of the track.

2.5. The track is 33 to 68 mil designation thickness.

Allowable in-plane shear strength of exempt anchors, parallel to the edge of concrete shall be permitted to be determined in accordance with AISI S100 Section E3.3.1.

3. In light-frame construction, bearing or nonbearing walls, shear strength of concrete anchors less than or equal to 1 inch [25 mm] in diameter attaching a sill plate or track to foundation or foundation stem wall need not satisfy ACI 318-11 D.3.3.5.3(a) through (c) when the design strength of the anchors is determined in accordance with ACI 318-11 D.6.2.1(c).

## 4.2 Strength Design of Post-Installed Reinforcing Bars:

**4.2.1 General:** The design of straight post-installed deformed reinforcing bars must be determined in accordance with ACI 318 rules for cast-in place reinforcing bar development and splices and this report.

Examples of typical applications for the use of post-installed reinforcing bars are illustrated in Figure 3 of this report.

**4.2.2 Determination of bar development length  $l_d$ :** Values of  $l_d$  must be determined in accordance with the ACI 318 development and splice length requirements for straight cast-in place reinforcing bars.

### Exceptions:

1. For uncoated and zinc-coated (galvanized) post-installed reinforcing bars, the factor  $\Psi_e$  shall be taken as 1.0. For all other cases, the requirements in ACI 318-19 25.4.2.5, ACI 318-14 25.4.2.4 or ACI 318-11 Section 12.2.4 (b) shall apply.

2. When using alternate methods to calculate the development length (e.g., anchor theory), the applicable factors for post-installed anchors generally apply.

**4.2.3 Minimum Member Thickness,  $h_{min}$ , Minimum Concrete Cover,  $C_{c,min}$ , Minimum Concrete Edge Distance,  $C_{b,min}$ , Minimum Spacing,  $s_{b,min}$ :** For post-installed reinforcing bars, there is no limit on the minimum member thickness. In general, all requirements on concrete cover and spacing applicable to straight cast-in bars designed in accordance with ACI 318 shall be maintained.

For post-installed reinforcing bars installed at embedment depths,  $h_{ef}$ , larger than  $20d$  ( $h_{ef} > 20d$ ), the minimum concrete cover shall be as follows:

REBAR SIZE	MINIMUM CONCRETE COVER, $C_{c,min}$
$d_b \leq \text{No. 6 (16mm)}$	$1\ 3/16 \text{ in. (30mm)}$
$\text{No. 6} < d_b \leq \text{No. 10}$ $(16\text{mm} < d_b \leq 32\text{mm})$	$1\ 9/16 \text{ in. (40mm)}$

The following requirements apply for minimum concrete edge and spacing for  $h_{ef} > 20d$ :

Required minimum edge distance for post-installed reinforcing bars (measured from the center of the bar):

$$C_{b,min} = d_o/2 + C_{c,min}$$

Required minimum center-to-center spacing between post-installed bars:

$$S_{b,min} = d_o + C_{c,min}$$

Required minimum center-to-center spacing from existing (parallel) reinforcing:

$$S_{b,min} = d_b/2 \text{ (existing reinforcing)} + d_o/2 + C_{c,min}$$

**4.2.4 Design Strength in Seismic Design Categories C, D, E and F:** In structures assigned to Seismic Category C, D, E or F under the IBC or IRC, design of straight post-installed reinforcing bars must take into account the provisions of ACI 318-19 or ACI 318-14 Chapter 18 or ACI 318-11 Chapter 21, as applicable.

## 4.3 Installation:

Installation parameters are illustrated in Figure 1. Installation must be in accordance with ACI 318-19 26.7.2, ACI 318-14 17.8.1 and 17.8.2 or ACI 318-11 D.9.1 and D.9.2, as applicable. Anchor and post-installed reinforcing bar locations must comply with this report and the plans and specifications approved by the code official. Installation of the Hilti HIT-HY 200 V3 Adhesive Anchor and Post-Installed Reinforcing Bar Systems must conform to the manufacturer's printed installation instructions (MPII) included in each unit package as provided in Figure 6 of this report. The MPII contains additional requirements for combinations of drill hole depth, diameter, drill bit type, and dispensing tools.

## 4.4 Special Inspection:

Periodic special inspection must be performed where required in accordance with Section 1705.1.1 and Table 1705.3 of the 2021, 2018, 2015 and 2012 IBC, and this report. The special inspector must be on the jobsite initially during anchor or post-installed reinforcing bar installation to verify anchor or post-installed reinforcing bar type and dimensions, concrete type, concrete compressive strength, adhesive identification and expiration date, hole dimensions, hole cleaning procedures, spacing, edge distances, concrete thickness, anchor or post-installed reinforcing bar embedment, tightening torque and adherence to the manufacturer's printed installation instructions.

The special inspector must verify the initial installations of each type and size of adhesive anchor or post-installed reinforcing bar by construction personnel on site. Subsequent installations of the same anchor or post-installed reinforcing bar type and size by the same construction personnel are permitted to be performed in the absence of the special inspector. Any change in the anchor or post-installed reinforcing bar product being installed or the personnel performing the installation requires an initial inspection. For ongoing installations over an extended period, the special inspector must make regular inspections to confirm correct handling and installation of the product.

Continuous special inspection of adhesive anchors or post-installed reinforcing bar installed in horizontal or upwardly inclined orientations to resist sustained tension loads shall be performed in accordance with ACI 318-19 26.13.3.2e and 26.7.1(j), ACI 318-14 17.8.2.4, 26.7.1(h), and 26.13.3.2(c) or ACI 318-11 D.9.2.4, as applicable.

Under the IBC, additional requirements as set forth in Sections 1705, 1706, and 1707 must be observed, where applicable.

## 5.0 CONDITIONS OF USE

The Hilti HIT-HY 200 V3 Adhesive Anchor System and Post-Installed Reinforcing Bar System described in this report complies with, or is a suitable alternative to what is specified in, the codes listed in Section 1.0 of this report, subject to the following conditions:

- 5.1 Hilti HIT-HY 200 V3 Adhesive anchors and post-installed reinforcing bars must be installed in accordance with the manufacturer's printed installation instructions (MPII) as included in the adhesive packaging and provided in Figure 6 of this report.
- 5.2 The anchors and post-installed reinforcing bars must be installed in cracked and uncracked normal-weight or lightweight concrete having a specified compressive strength  $f'_c = 2,500$  psi to 8,500 psi (17.2 MPa to 58.6 MPa).
- 5.3 The values of  $f'_c$  used for calculation purposes must not exceed 8,000 psi (55.1 MPa) except as noted in Sections 4.2.2 and 4.2.4 of this report.
- 5.4 The concrete shall have attained its minimum design strength prior to installation of the adhesive anchors.
- 5.5 Anchors and post-installed reinforcing bars must be installed in concrete base materials in holes predrilled in accordance with the instructions in Figure 6, using carbide-tipped masonry drill bits manufactured with the range of maximum and minimum drill-tip dimensions specified in ANSI B212.15-1994. The Hilti HIT-Z(-R) anchor rods may be installed in holes predrilled using diamond core drill bits. Threaded rods, reinforcing bars, and the Hilti HIS-(R)N inserts may be installed in holes predrilled using diamond core bits and roughened with the Hilti TE-YRT roughening tool as detailed in Figure 6.
- 5.6 Loads applied to the anchors must be adjusted in accordance with Section 1605.1 of the 2021 IBC or Section 1605.2 of the 2018, 2015 and 2012 IBC for strength design and in accordance with Section 1605.1 of the 2021 IBC or Section 1605.3 of the 2018, 2015, and 2012 IBC for allowable stress design.
- 5.7 Hilti HIT-HY 200 V3 adhesive anchors and post-installed reinforcing bars are recognized for use to resist short- and long-term loads, including wind and earthquake, subject to the conditions of this report.
- 5.8 In structures assigned to Seismic Design Category C, D, E or F under the IBC or IRC, anchor strength must be adjusted in accordance with Section 4.1.11 of this report, and post-installed reinforcing bars must comply with section 4.2.4 of this report.
- 5.9 Hilti HIT-HY 200 V3 adhesive anchors and post-installed reinforcing bars are permitted to be installed in concrete that is cracked or that may be expected to crack during the service life of the anchor, subject to the conditions of this report.
- 5.10 Anchor strength design values must be established in accordance with Section 4.1 of this report.
- 5.11 Post-installed reinforcing bar development and splice length is established in accordance with Section 4.2 of this report.
- 5.12 Minimum anchor spacing and edge distance as well as minimum member thickness must comply with the values noted in this report.
- 5.13 Post-installed reinforcing bar spacing, minimum member thickness, and cover distance must be in accordance with the provisions of ACI 318 for cast-in place bars and section 4.2.3 of this report.
- 5.14 Prior to anchor installation, calculations and details demonstrating compliance with this report must be submitted to the code official. The calculations and details must be prepared by a registered design professional where required by the statutes of the jurisdiction in which the project is to be constructed.
- 5.15 Anchors and post-installed reinforcing bars are not permitted to support fire-resistive construction. Where not otherwise prohibited by the code, Hilti HIT-HY 200 V3 adhesive anchors and post-installed reinforcing bars are permitted for installation in fire-resistive construction provided that at least one of the following conditions is fulfilled:
  - Anchors and post-installed reinforcing bars are used to resist wind or seismic forces only.
  - Anchors and post-installed reinforcing bars that support gravity load-bearing structural elements are within a fire-resistive envelope or a fire-resistive membrane, are protected by approved fire-resistive materials, or have been evaluated for resistance to fire exposure in accordance with recognized standards.
  - Anchors and post-installed reinforcing bars are used to support nonstructural elements.
- 5.16 Since an ICC-ES acceptance criteria for evaluating data to determine the performance of adhesive anchors and post-installed reinforcing bars subjected to fatigue or shock loading is unavailable at this time, the use of these anchors under such conditions is beyond the scope of this report.
- 5.17 Use of zinc-plated carbon steel threaded rods or steel reinforcing bars is limited to dry, interior locations.
- 5.18 Use of hot-dipped galvanized carbon steel and stainless steel rods is permitted for exterior exposure or damp environments.
- 5.19 Steel anchoring materials in contact with preservative-treated and fire-retardant-treated wood must be of zinc-coated carbon steel or stainless steel. The minimum coating weights for zinc-coated steel must comply with ASTM A153.
- 5.20 Periodic special inspection must be provided in accordance with Section 4.4 of this report. Continuous special inspection for anchors and post-installed reinforcing bars installed in horizontal or upwardly inclined orientations to resist sustained tension loads must be provided in accordance with Section 4.4 of this report.
- 5.21 Installation of anchors and post-installed reinforcing bars in horizontal or upwardly inclined orientations to resist sustained tension loads shall be performed by personnel certified by an applicable certification program in accordance with ACI 318-19 26.7.2(e), ACI 318-14 17.8.2.2 or 17.8.2.3, or ACI 318-11 D.9.2.2 or D.9.2.3, as applicable.

**5.22** Hilti HIT-HY 200 V3 adhesive anchors and post-installed reinforcing bars may be used to resist tension and shear forces in floor, wall, and overhead installations only if installation is into concrete with a temperature between 14°F and 104°F (-10°C and 40°C) for threaded rods, rebar, and Hilti HIS-(R)N inserts, or between 41°F and 104°F (5°C and 40°C) for Hilti HIT-Z(-R) anchor rods. (For post-installed reinforcing bars with embedment depth greater than 20d refer to additional temperature limitations in the MPII as provided in Figure 6 of this report). Overhead installations for hole diameters larger than  $\frac{7}{16}$ -inch or 10mm require the use of piston plugs (HIT-SZ, -IP) during injection to the back of the hole.  $\frac{7}{16}$ -inch diameter holes may be injected directly to the back of the hole with the use of extension tubing on the end of the nozzle. The anchor or post-installed reinforcing bars must be supported until fully cured (i.e., with Hilti HIT-OHW wedges, or other suitable means). Where temporary restraint devices are used, their use shall not result in impairment of the anchor shear resistance. Installations in concrete temperatures below 32°F require the adhesive to be conditioned to a minimum temperature of 32°F.

**5.23** Anchors and post-installed reinforcing bars when installed at temperatures below 40°F shall not be used for applications where the concrete temperature can rise from 40°F or less to 80°F or higher within a 12-hour period. Such applications may include, but are not limited to, anchorage of building façade systems and other applications subject to direct sun exposure.

**5.24** Hilti HIT-HY 200-A V3 and Hilti HIT-HY 200-R V3 adhesives are manufactured by Hilti GmbH, Kaufering, Germany, under a quality control program with inspections by ICC-ES.

**5.25** Hilti HIT-Z and HIT-Z-R rods are manufactured by Hilti AG, Schaan, Liechtenstein, under a quality-control program with inspections by ICC-ES.

**5.26** Hilti HIS-N and HIS-RN inserts are manufactured by Hilti (China) Ltd., Guangdong, China, under a quality-control program with inspections by ICC-ES.

## 6.0 EVIDENCE SUBMITTED

Data in accordance with the ICC-ES Acceptance Criteria for Post-installed Adhesive Anchors in Concrete Elements (AC308), dated June 2019, editorially revised February 2021, which incorporates requirements in ACI 355.4-11 and ACI 355.4-19, and Table 3.8 for evaluating post-installed reinforcing bars.

## 7.0 IDENTIFICATION

**7.1** Product labeling shall include, the name of the report holder or listee, and the ICC-ES mark of conformity. The listing or evaluation report number (ICC-ES ESR-4868) may be used in lieu of the mark of conformity. Hilti HIT-HY 200 A V3 and Hilti HIT HY 200 R V3 adhesive is identified by packaging labeled with the manufacturer's name (Hilti Corp.) and address, product name, lot number, expiration date, and evaluation report number (ESR-4868).

**7.2** Hilti HIT-Z and HIT-Z-R rods are identified by packaging labeled with the manufacturer's name (Hilti Corp.) and address, anchor name, and evaluation report number (ESR-4868).

**7.3** Hilti HIS-N and HIS-RN inserts are identified by packaging labeled with the manufacturer's name (Hilti Corp.) and address, anchor name and size, and evaluation report number (ESR-4868).

**7.4** Threaded rods, nuts, washers, bolts, cap screws, and deformed reinforcing bars are standard elements and must conform to applicable national or international specifications.

**7.5** The report holder's contact information is the following:

**HILTI, INC.**  
**7250 DALLAS PARKWAY, SUITE 1000**  
**PLANO, TEXAS 75024**  
**(800) 879-8000**  
[www.hilti.com](http://www.hilti.com)  
[HiltiTechEng@us.hilti.com](mailto:HiltiTechEng@us.hilti.com)

**HILTI HIT-Z AND HIT-Z-R ANCHOR ROD**

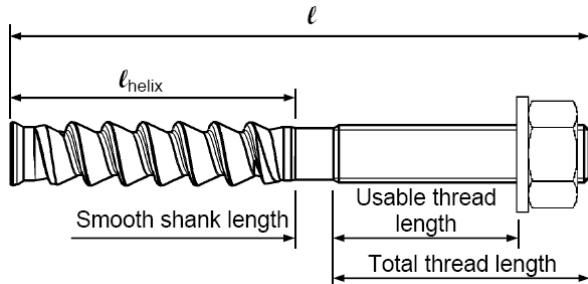
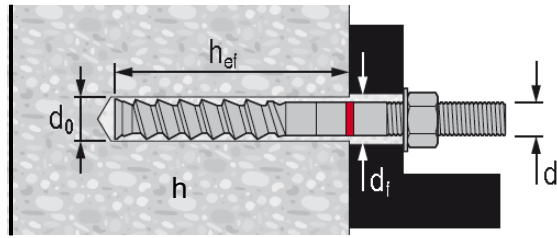

**FRACTIONAL HIT-Z AND HIT-Z-R ANCHOR ROD**

Ø d [inch]	Ø d <sub>0</sub> [inch]	h <sub>ef</sub> [inch]	T <sub>inst</sub> [ft-lb]		T <sub>inst</sub> [Nm]	
			HIT-Z	HIT-Z-R	HIT-Z	HIT-Z-R
3/8	7/16	2 3/8 ... 4 1/2	15	30	20	40
1/2	9/16	2 3/4 ... 6	30	65	40	90
5/8	3/4	3 3/4 ... 7 1/2	60	125	80	170
3/4	7/8	4 ... 8 1/2	110	165	150	220

**METRIC HIT-Z AND HIT-Z-R ANCHOR ROD**

Ø d [mm]	Ø d <sub>0</sub> [mm]	h <sub>nom</sub> [mm]	T <sub>inst</sub> [Nm]	
			HIT-Z	HIT-Z-R
M10	12	60...120	25	55
M12	14	70...144	40	75
M16	18	96...192	80	155
M20	22	100...220	150	215

Name and Size	ℓ Anchor Length		ℓ <sub>helix</sub> Helix Length		Smooth Shank Length		Total Thread Length		Usable Thread Length	
	in	(mm)	in	(mm)	in	(mm)	In	(mm)	in	(mm)
HIT-Z(-R) 3/8" x 3 3/8"	3 3/8	(85)	2 1/4	(57)	3/8	(6)	1 3/16	(21)	5/16	(8)
HIT-Z(-R) 3/8" x 4 3/8"	4 3/8	(111)	2 1/4	(57)	5/16	(8)	1 13/16	(46)	1 5/16	(33)
HIT-Z(-R) 3/8" x 5 1/8"	5 1/8	(130)	2 1/4	(57)	5/16	(8)	2 9/16	(65)	2 1/16	(52)
HIT-Z(-R) 3/8" x 6 3/8"	6 3/8	(162)	2 1/4	(57)	5/16	(8)	3 13/16	(97)	3 5/16	(84)
HIT-Z(-R) 1/2" x 4 1/2"	4 1/2	(114)	2 1/2	(63)	5/16	(8)	1 11/16	(43)	1	(26)
HIT-Z(-R) 1/2" x 6 1/2"	6 1/2	(165)	2 1/2	(63)	5/16	(8)	3 11/16	(94)	3 1/16	(77)
HIT-Z(-R) 1/2" x 7 3/4"	7 3/4	(197)	2 1/2	(63)	5/16	(8)	4 15/16	(126)	4 5/16	(109)
HIT-Z(-R) 5/8" x 6"	6	(152)	3 5/8	(92)	7/16	(11)	1 15/16	(49)	1 1/8	(28)
HIT-Z(-R) 5/8" x 8"	8	(203)	3 5/8	(92)	7/16	(11)	3 15/16	(100)	3 1/8	(79)
HIT-Z(-R) 5/8" x 9 1/2"	9 1/2	(241)	3 5/8	(92)	1 15/16	(49)	3 15/16	(100)	3 1/8	(79)
HIT-Z(-R) 3/4" x 6 1/2"	6 1/2	(165)	4	(102)	5/16	(8)	2	(51)	1	(26)
HIT-Z(-R) 3/4" x 8 1/2"	8 1/2	(216)	4	(102)	7/16	(12)	4	(102)	3 1/16	(77)
HIT-Z(-R) 3/4" x 9 3/4"	9 3/4	(248)	4	(102)	1 11/16	(44)	4	(102)	3 1/16	(77)
HIT-Z(-R) M10x95	3 3/4	(95)	1 15/16	(50)	1 1/16	(18)	1 1/8	(27)	9/16	(14)
HIT-Z(-R) M10x115	4 1/2	(115)	1 15/16	(50)	1 1/16	(18)	1 7/8	(47)	1 5/16	(34)
HIT-Z(-R) M10x135	5 5/16	(135)	1 15/16	(50)	1 1/16	(18)	2 5/8	(67)	2 1/8	(54)
HIT-Z(-R) M10x160	6 5/16	(160)	1 15/16	(50)	1 1/16	(18)	3 5/8	(92)	3 1/8	(79)
HIT-Z(-R) M12x105	4 1/8	(105)	2 3/8	(60)	5/16	(8)	1 1/2	(37)	1 3/16	(21)
HIT-Z(-R) M12x140	5 1/2	(140)	2 3/8	(60)	5/16	(8)	2 7/8	(72)	2 3/16	(56)
HIT-Z(-R) M12x155	6 1/8	(155)	2 3/8	(60)	5/16	(8)	3 3/8	(87)	2 13/16	(71)
HIT-Z(-R) M12x196	7 3/4	(196)	2 3/8	(60)	5/16	(8)	5	(128)	4 7/16	(112)
HIT-Z(-R) M16x155	6 1/8	(155)	3 11/16	(93)	7/16	(11)	2	(51)	1 3/16	(30)
HIT-Z(-R) M16x175	6 7/8	(175)	3 11/16	(93)	7/16	(11)	2 13/16	(71)	1 15/16	(50)
HIT-Z(-R) M16x205	8 1/16	(205)	3 11/16	(93)	7/16	(11)	4	(101)	3 1/8	(80)
HIT-Z(-R) M16x240	9 7/16	(240)	3 11/16	(93)	1 1/4	(32)	4 1/2	(115)	3 11/16	(94)
HIT-Z(-R) M20x215	8 1/2	(215)	3 15/16	(100)	1/2	(13)	4	(102)	3 1/16	(78)
HIT-Z(-R) M20x250	9 13/16	(250)	3 15/16	(100)	1 7/8	(48)	4	(102)	3 1/16	(78)

**FIGURE 1—INSTALLATION PARAMETERS FOR POST-INSTALLED ADHESIVE ANCHORS**

**DEFORMED REINFORCEMENT**

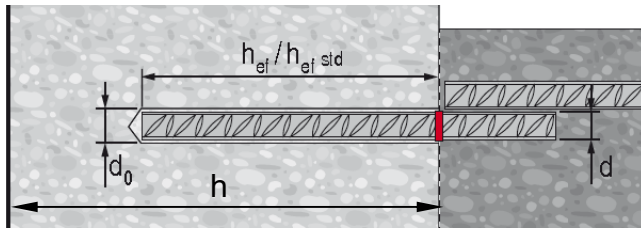

**US REBAR**

d	Ø d <sub>0</sub> [inch]	h <sub>ef</sub> std [inch]	h <sub>ef</sub> [inch]
#3	1/2	3 3/8	2 3/8...7 1/2
#4	5/8	4 1/2	2 3/4...10
#5	3/4	5 3/8	3 1/8...12 1/2
#6	7/8	6 3/4	3 1/2...15
#7	1	7 7/8	3 1/2...17 1/2
#8	1 1/8	9	4...20
#9	1 3/8	10 1/8	4 1/2...22 1/2
#10	1 1/2	11 1/4	5...25

**CANADIAN REBAR**

d	Ø d <sub>0</sub> [inch]	h <sub>ef</sub> std [mm]	h <sub>ef</sub> [mm]
10 M	9/16	115	70...226
15 M	3/4	145	80...320
20 M	1	200	90...390
25 M	1 1/4	230	101...504
30 M	1 1/2	260	120...598

**EUROPEAN REBAR**

Ø d [mm]	Ø d <sub>0</sub> [mm]	h <sub>ef</sub> std [mm]	h <sub>ef</sub> [mm]
10	14	90	60...200
12	16	110	70...240
14	18	125	75...280
16	20	125	80...320
20	25	170	90...400
25	32	210	100...500
28	35	270	112...560
32	40	300	128...640

**THREADED ROD**

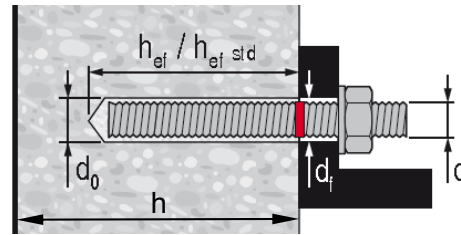

**FRACTIONAL THREADED ROD**

Ø d [inch]	Ø d <sub>0</sub> [inch]	h <sub>ef</sub> std [inch]	h <sub>ef</sub> [inch]	T <sub>max</sub> [ft-lb]	T <sub>max</sub> [Nm]
3/8	7/16	3 3/8	2 3/8...7 1/2	15	20
1/2	9/16	4 1/2	2 3/4...10	30	41
5/8	3/4	5 5/8	3 1/8...12 1/2	60	81
3/4	7/8	6 3/4	3 1/2...15	100	136
7/8	1	7 7/8	3 1/2...17 1/2	125	169
1	1 1/8	9	4...20	150	203
1 1/4	1 3/8	11 1/4	5...25	200	271

**METRIC THREADED ROD**

Ø d [mm]	Ø d <sub>0</sub> [mm]	h <sub>ef</sub> std [mm]	h <sub>ef</sub> [mm]	T <sub>max</sub> [Nm]
M10	12	90	60...200	20
M12	14	110	70...240	40
M16	18	125	80...320	80
M20	22	170	90...400	150
M24	28	210	96...480	200
M27	30	240	108...540	270
M30	35	270	120...600	300

**HILTI HIS-N AND HIS-RN THREADED INSERTS**

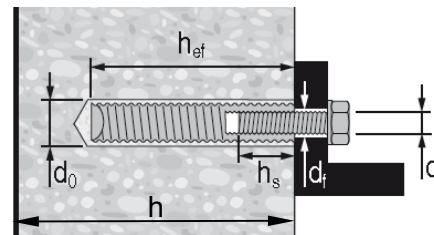

**FRACTIONAL HILTI HIS-N AND HIS-RN THREADED INSERTS**

Ø d [inch]	Ø d <sub>0</sub> [inch]	h <sub>ef</sub> [inch]	Ø d <sub>i</sub> [inch]	h <sub>s</sub> [inch]	T <sub>max</sub> [ft-lb]	T <sub>max</sub> [Nm]
3/8	1 1/16	4 3/8	7/16	3/8...1 5/16	15	20
1/2	7/8	5	9/16	1/2...1 3/16	30	41
5/8	1 1/8	6 3/4	1 1/16	5/8...1 1/2	60	81
3/4	1 1/4	8 1/8	1 3/16	3/4...1 7/8	100	136

**METRIC HILTI HIS-N AND HIS-RN THREADED INSERTS**

Ø d [mm]	Ø d <sub>0</sub> [mm]	h <sub>ef</sub> [mm]	Ø d <sub>i</sub> [mm]	h <sub>s</sub> [mm]	T <sub>max</sub> [Nm]
M8	14	90	9	8...20	10
M10	18	110	12	10...25	20
M12	22	125	14	12...30	40
M16	28	170	18	16...40	80
M20	32	205	22	20...50	150

**FIGURE 1—INSTALLATION PARAMETERS FOR POST INSTALLED ADHESIVE ANCHORS (Continued)**

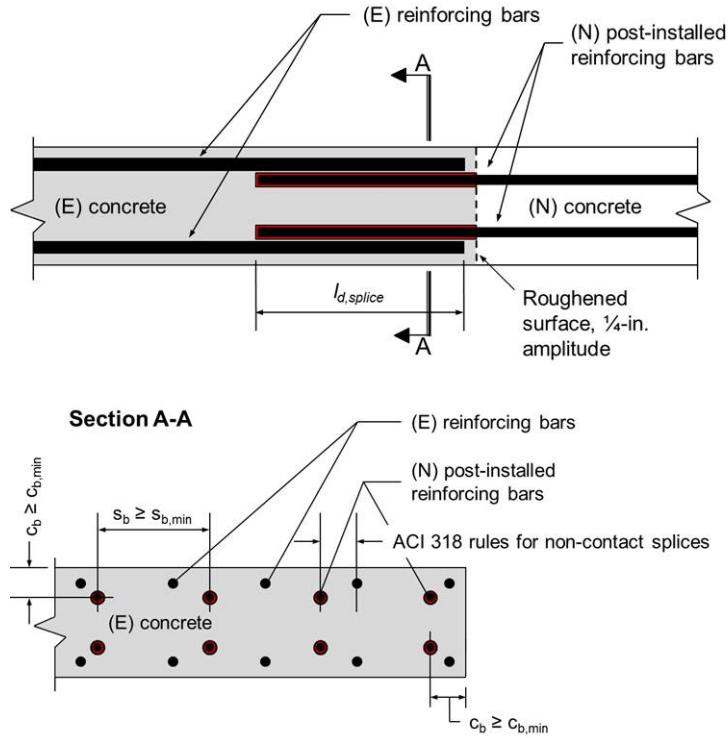

FIGURE 2—INSTALLATION PARAMATERS FOR POST-INSTALLED REINFORCING BARS

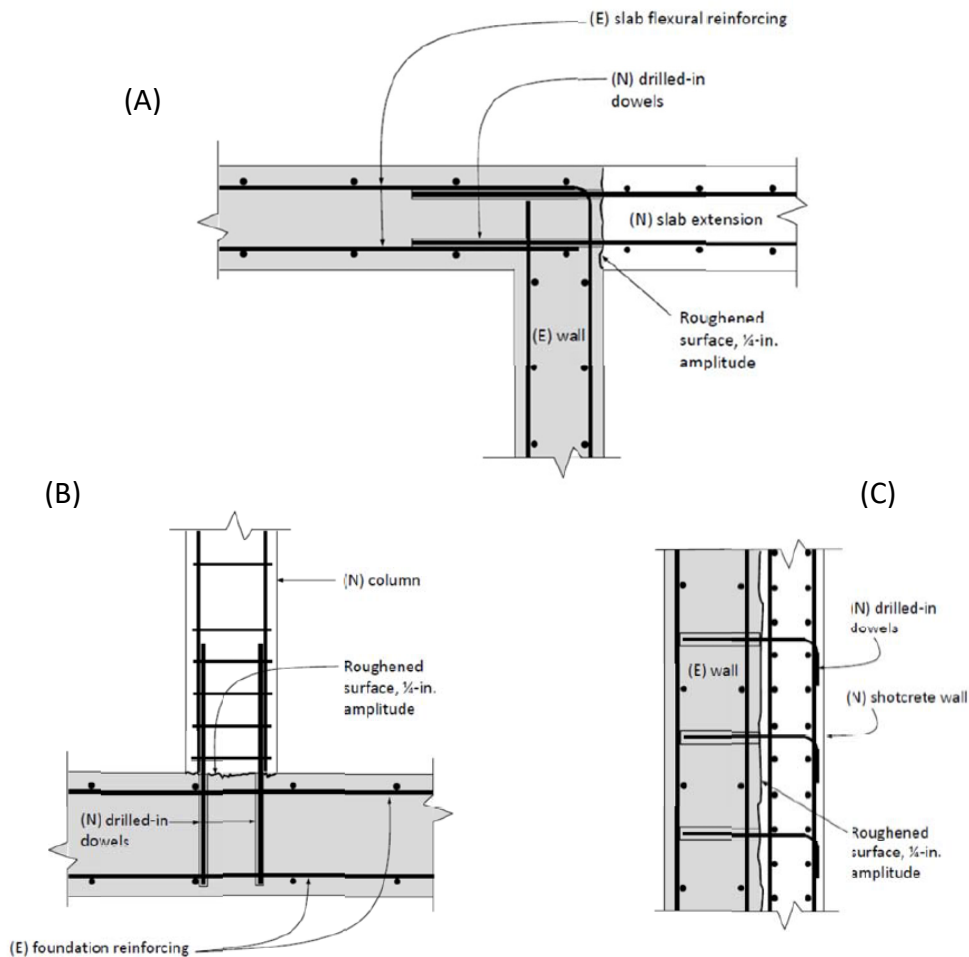







FIGURE 3—APPLICATION EXAMPLES FOR POST-INSTALLED REINFORCING BARS:  
 (A) TENSION LAP SPLICE WITH EXISTING FLEXURAL REINFORCEMENT; (B) TENSION DEVELOPMENT OF COLUMN DOWELS;  
 (C) DEVELOPMENT OF SHEAR DOWELS FOR NEWLY THICKENED SHEAR WALL

TABLE 1—DESIGN TABLE INDEX

Design Table		Fractional		Metric			
		Table	Page	Table	Page		
	Steel Strength - $N_{sa}, V_{sa}$	7	14	7	14		
	Concrete Breakout - $N_{cb}, N_{cbg}, V_{cb}, V_{cbg}, V_{cp}, V_{cpg}$	8	15	8	15		
	Pullout Strength - $N_p$	10	19	10	19		
	Steel Strength - $N_{sa}, V_{sa}$	11	20	17	27		
	Concrete Breakout - $N_{cb}, N_{cbg}, V_{cb}, V_{cbg}, V_{cp}, V_{cpg}$	12	22	18	28		
	Bond Strength - $N_a, N_{ag}$	15 & 16	25 & 26	21 & 22	31 & 32		
	Steel Strength - $N_{sa}, V_{sa}$	27	36	27	36		
	Concrete Breakout - $N_{cb}, N_{cbg}, V_{cb}, V_{cbg}, V_{cp}, V_{cpg}$	28	37	28	37		
	Bond Strength - $N_a, N_{ag}$	29	38	29	38		
Design Table		Fractional		EU Metric		Canadian	
		Table	Page	Table	Page	Table	Page
	Steel Strength - $N_{sa}, V_{sa}$	11A	21	17	27	23	33
	Concrete Breakout - $N_{cb}, N_{cbg}, V_{cb}, V_{cbg}, V_{cp}, V_{cpg}$	12	22	18	28	24	33
	Bond Strength - $N_a, N_{ag}$	13 & 14	23 & 24	19 & 20	29 & 30	25 & 26	34 & 35
	Determination of development length for post-installed reinforcing bar connections	30	39	31	40	32	40



**TABLE 2—SPECIFICATIONS AND PHYSICAL PROPERTIES OF FRACTIONAL AND METRIC HIT-Z AND HIT-Z RODS**

HIT-Z AND HIT-Z-R ROD SPECIFICATION			Minimum specified ultimate strength, $f_{uta}$	Minimum specified yield strength 0.2 percent offset, $f_{ya}$	$f_{uta}/f_{ya}$	Elongation, min. percent	Reduction of Area, min. percent	Specification for nuts <sup>2</sup>
CARBON STEEL								
	$\frac{3}{8}$ -in. to $\frac{5}{8}$ -in. and M10 to M12 - AISI 1038	psi	94,200	75,300	1.25	8	20	ASTM A563 Grade A
	$\frac{3}{4}$ -in. - AISI 1038 or 18MnV5	(MPa)	(650)	(520)				
M16 - AISI 1038	psi	88,400	71,000					
		(MPa)	(610)	(490)				
	M20 - AISI 1038 or 18MnV5	psi	86,200	69,600				
		(MPa)	(595)	(480)				
STAINLESS STEEL	$\frac{3}{8}$ -in. to $\frac{3}{4}$ -in. and M10 to M12 Grade 316 DIN-EN 10263-5 X5CrNiMo 17-12-2+AT	psi	94,200	75,300	1.25	8	20	ASTM F594 Type 316
	M16 Grade 316 DIN-EN 10263-5 X5CrNiMo 17-12-2+AT	psi	88,400	71,000				
		(MPa)	(610)	(490)				
	M20 Grade 316 DIN-EN 10263-5 X5CrNiMo 17-12-2+AT	psi	86,200	69,600				
		(MPa)	(595)	(480)				

<sup>1</sup> Steel properties are minimum values and maximum values will vary due to the cold forming of the rod.

<sup>2</sup> Nuts of other grades and styles having specified proof load stresses greater than the specified grade and style are also suitable. Nuts must have specified proof load stresses equal to or greater than the minimum tensile strength of the specified threaded rod.

**TABLE 3—SPECIFICATIONS AND PHYSICAL PROPERTIES OF COMMON CARBON AND STAINLESS STEEL THREADED ROD MATERIALS<sup>1</sup>**

THREADED ROD SPECIFICATION			Minimum specified ultimate strength, $f_{uta}$	Minimum specified yield strength 0.2 percent offset, $f_{ya}$	$f_{uta}/f_{ya}$	Elongation, min. percent <sup>7</sup>	Reduction of Area, min. percent	Specification for nuts <sup>8</sup>
CARBON STEEL								
	ASTM A193 <sup>2</sup> Grade B7 $\leq 2\frac{1}{2}$ in. ( $\leq 64$ mm)	psi	125,000	105,000	1.19	16	50	ASTM A563 Grade DH
		(MPa)	(862)	(724)				
	ASTM F568M <sup>3</sup> Class 5.8 M5 ( $\frac{1}{4}$ in.) to M24 (1 in.) (equivalent to ISO 898-1)	psi	72,500	58,000	1.25	10	35	ASTM A563 Grade DH <sup>9</sup> DIN 934 (8-A2K)
		(MPa)	(500)	(400)				
	ASTM F1554, Grade 36 <sup>7</sup>	psi	58,000	36,000	1.61	23	40	ASTM A194 or ASTM A563
		(MPa)	(400)	(248)				
ASTM F1554, Grade 55 <sup>7</sup>	psi	75,000	55,000	1.36	21	30	ASTM A194 or ASTM A563	
	(MPa)	(517)	(379)					
ASTM F1554, Grade 105 <sup>7</sup>	psi	125,000	105,000	1.19	15	45	ASTM A194 or ASTM A563	
	(MPa)	(862)	(724)					
ISO 898-1 <sup>4</sup> Class 5.8	MPa	500	400	1.25	22	-	DIN 934 Grade 6	
	(psi)	(72,500)	(58,000)					
ISO 898-1 <sup>4</sup> Class 8.8	MPa	800	640	1.25	12	52	DIN 934 Grade 8	
	(psi)	(116,000)	(92,800)					
STAINLESS STEEL	ASTM F593 <sup>5</sup> CW1 (316) $\frac{1}{4}$ -in. to $\frac{5}{8}$ -in.	psi	100,000	65,000	1.54	20	-	ASTM F594
		(MPa)	(689)	(448)				
	ASTM F593 <sup>5</sup> CW2 (316) $\frac{3}{4}$ -in. to $1\frac{1}{2}$ -in.	psi	85,000	45,000	1.89	25	-	ASTM F594
		(MPa)	(586)	(310)				
	ASTM A193 Grade 8(M), Class 1 <sup>2</sup> - $1\frac{1}{4}$ -in.	psi	75,000	30,000	2.50	30	50	ASTM F594
	(MPa)	(517)	(207)					
ISO 3506-1 <sup>6</sup> A4-70 M8 - M24	MPa	700	450	1.56	40	-	ISO 4032	
	(psi)	(101,500)	(65,250)					
ISO 3506-1 <sup>6</sup> A4-50 M27 - M30	MPa	500	210	2.38	40	-	ISO 4032	
	(psi)	(72,500)	(30,450)					

<sup>1</sup> Hilti HIT-HY 200 V3 adhesive may be used in conjunction with all grades of continuously threaded carbon or stainless steel rod (all-thread) that comply with the code reference standards and that have thread characteristics comparable with ANSI B1.1 UNC Coarse Thread Series or ANSI B1.13M M Profile Metric Thread Series. Values for threaded rod types and associated nuts supplied by Hilti are provided here.

<sup>2</sup> Standard Specification for Alloy-Steel and Stainless Steel Bolting Materials for High-Temperature Service

<sup>3</sup> Standard Specification for Carbon and Alloy Steel Externally Threaded Metric Fasteners

<sup>4</sup> Mechanical properties of fasteners made of carbon steel and alloy steel - Part 1: Bolts, screws and studs

<sup>5</sup> Standard Steel Specification for Stainless Steel Bolts, Hex Cap Screws, and Studs

<sup>6</sup> Mechanical properties of corrosion-resistant stainless steel fasteners - Part 1: Bolts, screws and studs

<sup>7</sup> Based on 2-in. (50 mm) gauge length except for A 193, which are based on a gauge length of 4d and ISO 898, which is based on 5d.

<sup>8</sup> Nuts of other grades and styles having specified proof load stresses greater than the specified grade and style are also suitable. Nuts must have specified proof load stresses equal to or greater than the minimum tensile strength of the specified threaded rod.

<sup>9</sup> Nuts for fractional rods.

TABLE 4—SPECIFICATIONS AND PHYSICAL PROPERTIES OF COMMON STEEL REINFORCING BARS

REINFORCING BAR SPECIFICATION 		Minimum specified ultimate strength, $f_{uta}$	Minimum specified yield strength, $f_{ya}$
ASTM A615 <sup>1</sup> Gr. 60	psi (MPa)	80,000 (550)	60,000 (414)
ASTM A615 <sup>1</sup> Gr. 40	psi (MPa)	60,000 (414)	40,000 (276)
ASTM A706 <sup>2</sup> Gr. 60	psi (MPa)	80,000 (550)	60,000 (414)
DIN 488 <sup>3</sup> BSt 500	MPa (psi)	550 (79,750)	500 (72,500)
CAN/CSA-G30.18 <sup>4</sup> Gr. 400	MPa (psi)	540 (78,300)	400 (58,000)

<sup>1</sup> Standard Specification for Deformed and Plain Carbon Steel Bars for Concrete Reinforcement

<sup>2</sup> Standard Specification for Low Alloy Steel Deformed and Plain Bars for Concrete Reinforcement

<sup>3</sup> Reinforcing steel; reinforcing steel bars; dimensions and masses

<sup>4</sup> Billet-Steel Bars for Concrete Reinforcement

TABLE 5—SPECIFICATIONS AND PHYSICAL PROPERTIES OF FRACTIONAL AND METRIC HIS-N AND HIS-RN INSERTS



HILTI HIS-N AND HIS-RN INSERTS 		Minimum specified ultimate strength, $f_{uta}$	Minimum specified yield strength, $f_{ya}$
Carbon Steel DIN EN 10277-3 11SMnPb30+c or DIN 1561 9SMnPb28K <sup>3</sup> / <sub>8</sub> -in. and M8 to M10	psi (MPa)	71,050 (490)	59,450 (410)
Carbon Steel DIN EN 10277-3 11SMnPb30+c or DIN 1561 9SMnPb28K <sup>1</sup> / <sub>2</sub> to <sup>3</sup> / <sub>4</sub> -in. and M12 to M20	psi (MPa)	66,700 (460)	54,375 (375)
Stainless Steel EN 10088-3 X5CrNiMo 17-12-2	psi (MPa)	101,500 (700)	50,750 (350)

TABLE 6—SPECIFICATIONS AND PHYSICAL PROPERTIES OF COMMON BOLTS, CAP SCREWS AND STUDS FOR USE WITH HIS-N AND HIS-RN INSERTS<sup>1,2</sup>

BOLT, CAP SCREW OR STUD SPECIFICATION 		Minimum specified ultimate strength $f_{uta}$	Minimum specified yield strength 0.2 percent offset $f_{ya}$	$f_{uta}/f_{ya}$	Elongation, min.	Reduction of Area, min.	Specification for nuts <sup>6</sup>
SAE J429 <sup>3</sup> Grade 5	psi (MPa)	120,000 (828)	92,000 (634)	1.30	14	35	SAE J995
ASTM A325 <sup>4</sup> <sup>1</sup> / <sub>2</sub> to 1-in.	psi (MPa)	120,000 (828)	92,000 (634)	1.30	14	35	A563 C, C3, D, DH, DH3 Heavy Hex
ASTM A193 <sup>5</sup> Grade B8M (AISI 316) for use with HIS-RN	psi (MPa)	110,000 (759)	95,000 (655)	1.16	15	45	ASTM F594 <sup>7</sup> Alloy Group 1, 2 or 3
ASTM A193 <sup>5</sup> Grade B8T (AISI 321) for use with HIS-RN	psi (MPa)	125,000 (862)	100,000 (690)	1.25	12	35	ASTM F594 <sup>7</sup> Alloy Group 1, 2 or 3

<sup>1</sup> Minimum Grade 5 bolts, cap screws or studs must be used with carbon steel HIS inserts.

<sup>2</sup> Only stainless steel bolts, cap screws or studs must be used with HIS-RN inserts.

<sup>3</sup> Mechanical and Material Requirements for Externally Threaded Fasteners

<sup>4</sup> Standard Specification for Structural Bolts, Steel, Heat Treated, 120/105 ksi Minimum Tensile Strength

<sup>5</sup> Standard Specification for Alloy-Steel and Stainless Steel Bolting Materials for High-Temperature Service

<sup>6</sup> Nuts must have specified minimum proof load stress equal to or greater than the specified minimum full-size tensile strength of the specified stud.

<sup>7</sup> Nuts for stainless steel studs must be of the same alloy group as the specified bolt, cap screw, or stud.



Fractional and Metric HIT-Z and HIT-Z-R Anchor Rod

Steel Strength

TABLE 7—STEEL DESIGN INFORMATION FOR FRACTIONAL AND METRIC HIT-Z AND HIT-Z-R ANCHOR RODS

DESIGN INFORMATION	Symbol	Units	Nominal Rod Dia. (in.) Fractional				Units	Nominal Rod Dia. (mm) Metric				
			<sup>3</sup> / <sub>8</sub>	<sup>1</sup> / <sub>2</sub>	<sup>5</sup> / <sub>8</sub>	<sup>3</sup> / <sub>4</sub>		10	12	16	20	
Rod O.D.	<i>d</i>	in. (mm)	0.375 (9.5)	0.5 (12.7)	0.625 (15.9)	0.75 (19.1)	mm (in.)	10 (0.39)	12 (0.47)	16 (0.63)	20 (0.79)	
Rod effective cross-sectional area	<i>A<sub>se</sub></i>	in. <sup>2</sup> (mm <sup>2</sup> )	0.0775 (50)	0.1419 (92)	0.2260 (146)	0.3340 (216)	mm <sup>2</sup> (in. <sup>2</sup> )	58.0 (0.090)	84.3 (0.131)	157.0 (0.243)	245.0 (0.380)	
CARBON STEEL	Nominal strength as governed by steel strength <sup>1</sup>	<i>N<sub>sa</sub></i>	lb (kN)	7,306 (32.5)	13,377 (59.5)	21,306 (94.8)	31,472 (140.0)	kN (lb)	37.7 (8,475)	54.8 (12,318)	95.8 (21,529)	145.8 (32,770)
		<i>V<sub>sa</sub></i>	lb (kN)	3,215 (14.3)	5,886 (26.2)	9,375 (41.7)	13,848 (61.6)	kN (lb)	16.6 (3,729)	24.1 (5,420)	42.2 (9,476)	64.2 (14,421)
	Reduction for seismic shear	<i>α<sub>V,seis</sub></i>	-	0.65				-	0.65			
	Strength reduction factor for tension <sup>2</sup>	<i>φ</i>	-	0.65				-	0.65			
	Strength reduction factor for shear <sup>2</sup>	<i>φ</i>	-	0.60				-	0.60			
STAINLESS STEEL	Nominal strength as governed by steel strength <sup>1</sup>	<i>N<sub>sa</sub></i>	lb (kN)	7,306 (32.5)	13,377 (59.5)	21,306 (94.8)	31,472 (140.0)	kN (lb)	37.7 (8,475)	54.8 (12,318)	95.8 (21,529)	145.8 (32,770)
		<i>V<sub>sa</sub></i>	lb (kN)	4,384 (19.5)	8,026 (35.7)	12,783 (56.9)	18,883 (84.0)	kN (lb)	22.6 (5,085)	32.9 (7,391)	57.5 (12,922)	87.5 (19,666)
	Reduction for seismic shear	<i>α<sub>V,seis</sub></i>	-	0.79	0.75	0.65		-	0.79	0.75	0.65	
	Strength reduction factor for tension <sup>2</sup>	<i>φ</i>	-	0.65				-	0.65			
	Strength reduction factor for shear <sup>2</sup>	<i>φ</i>	-	0.60				-	0.60			

For SI: 1 inch = 25.4 mm, 1 lbf = 4.448 N, 1 psi = 0.006897 MPa.  
 For pound-inch units: 1 mm = 0.03937 inches, 1 N = 0.2248 lbf, 1 MPa = 145.0 psi

<sup>1</sup> Steel properties are minimum values and maximum values will vary due to the cold forming of the rod.  
<sup>2</sup> For use with the load combinations of ACI 318-19 and ACI 318-14 5.3 or ACI 318-11 9.2, as set forth in ACI 318-19 17.5.3, ACI 318-14 17.3.3 or ACI 318-11 D.4.3.

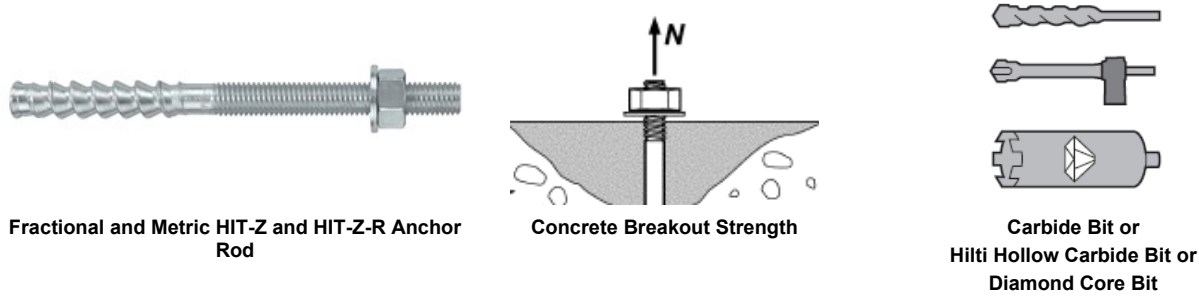
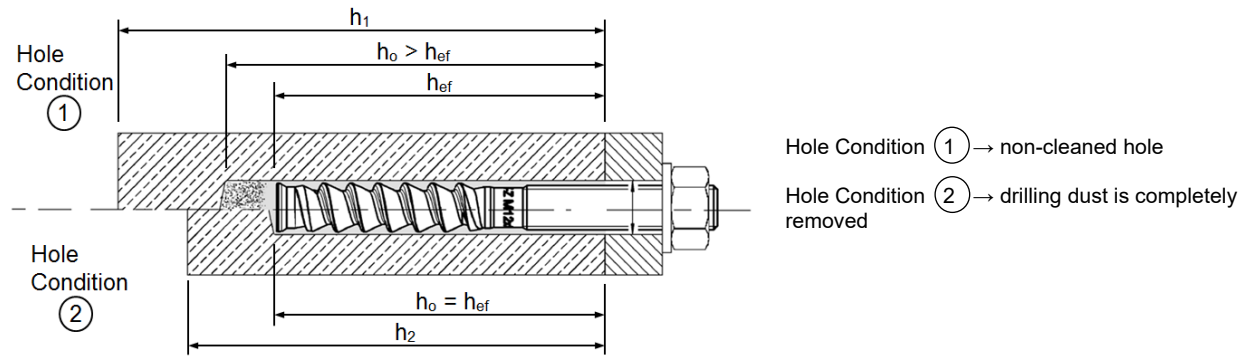

**TABLE 8—CONCRETE BREAKOUT DESIGN INFORMATION FOR U.S. CUSTOMARY UNIT HIT-Z AND HIT-Z-R ANCHOR ROD IN HOLES DRILLED WITH A HAMMER DRILL AND CARBIDE BIT (OR HILTI HOLLOW CARBIDE DRILL BIT) OR A CORE DRILL<sup>1</sup>**

DESIGN INFORMATION	Symbol	Units	Nominal Rod Dia. (in.) Fractional				Units	Nominal Rod Dia. (mm) Metric			
			3/8	1/2	5/8	3/4		10	12	16	20
Effectiveness factor for cracked concrete	$k_{c,cr}$	in-lb (SI)	17 (7.1)				SI (in-lb)	7.1 (17)			
Effectiveness factor for uncracked concrete	$k_{c,uncr}$	in-lb (SI)	24 (10)				SI (in-lb)	10 (24)			
Minimum embedment depth <sup>3</sup>	$h_{ef,min}$	in. (mm)	2 <sup>3</sup> / <sub>8</sub> (60)	2 <sup>3</sup> / <sub>4</sub> (70)	3 <sup>3</sup> / <sub>4</sub> (95)	4 (102)	mm (in.)	60 (2.4)	70 (2.8)	96 (3.8)	100 (3.9)
Maximum embedment depth <sup>3</sup>	$h_{ef,max}$	in. (mm)	4 <sup>1</sup> / <sub>2</sub> (114)	6 (152)	7 <sup>1</sup> / <sub>2</sub> (190)	8 <sup>1</sup> / <sub>2</sub> (216)	mm (in.)	120 (4.7)	144 (5.7)	192 (7.6)	220 (8.7)
Min. anchor spacing	$s_{min}$	-	See Section 4.1.9.1 of this report.				-	See Section 4.1.9.1 of this report.			
Min. edge distance	$c_{min}$	-	Pre-calculated combinations of anchor spacing and edge distance are given in Table 9 of this report.				-	Pre-calculated combinations of anchor spacing and edge distance are given in Table 9 of this report.			
Minimum concrete thickness Hole condition 1 <sup>3</sup>	$h_{min,1}$	in. (mm)	$h_{ef} + 2\frac{1}{4}$ ( $h_{ef} + 57$ )		$h_{ef} + 4$ ( $h_{ef} + 102$ )		mm (in.)	$h_{ef} + 60$ ( $h_{ef} + 2.4$ )		$h_{ef} + 100$ ( $h_{ef} + 3.9$ )	
Minimum concrete thickness Hole condition 2 <sup>3</sup>	$h_{min,2}$	in. (mm)	$h_{ef} + 1\frac{1}{4} \geq 4$ ( $h_{ef} + 32 \geq 100$ )		$h_{ef} + 1\frac{3}{4}$ ( $h_{ef} + 45$ )		mm (in.)	$h_{ef} + 30 \geq 100$ ( $h_{ef} + 1.25 \geq 3.9$ )		$h_{ef} + 45$ ( $h_{ef} + 1.8$ )	
Critical edge distance – splitting (for uncracked concrete)	$c_{ac}$	-	See Section 4.1.10.1 of this report				-	See Section 4.1.10.1 of this report			
Strength reduction factor for tension, concrete failure modes, Condition B (supplemental reinforcement not present) <sup>2</sup>	$\phi$	-	0.65				-	0.65			
Strength reduction factor for shear, concrete failure modes, Condition B (supplemental reinforcement not present) <sup>2</sup>	$\phi$	-	0.70				-	0.70			

For SI: 1 inch  $\equiv$  25.4 mm, 1 lbf = 4.448 N, 1 psi = 0.006897 MPa.  
 For pound-inch units: 1 mm = 0.03937 inches, 1 N = 0.2248 lbf, 1 MPa = 145.0 psi

<sup>1</sup> Additional setting information is described in Figure 6, Manufacturers Printed Installation Instructions (MPII).  
<sup>2</sup> The strength reduction factor applies when the load combinations from the IBC or ACI 318 are used and the requirements of ACI 318-19 17.5.3, ACI 318-14 17.3.3 or ACI 318-11 D.4.3, as applicable, are met. If the load combinations of ACI 318-11 Appendix C are used, the appropriate strength reduction factor must be determined in accordance with ACI 318-11 D.4.4.<sup>3</sup> Borehole condition is described in Figure 4 below.



**FIGURE 4—BOREHOLE SETTING CONDITIONS FOR HILTI HIT-Z AND HIT-Z-R ANCHOR RODS**

**TABLE 9—PRE-CALCULATED EDGE DISTANCE AND SPACING COMBINATIONS FOR HILTI HIT-Z AND HIT-Z-R RODS**

DESIGN INFORMATION			Symbol	Units	Nominal Rod Diameter (in.) – Fractional								
Rod O.D.			<i>d</i>	in. (mm)	<sup>3</sup> / <sub>8</sub> (9.5)								
Effective embedment			<i>h<sub>ef</sub></i>	in. (mm)	2 <sup>3</sup> / <sub>8</sub> (60)			3 <sup>3</sup> / <sub>8</sub> (86)		4 <sup>1</sup> / <sub>2</sub> (114)			
Drilled hole condition <sup>1</sup>			-	-	2	1 or 2		2	1 or 2		2	1 or 2	
Minimum concrete thickness			<i>h</i>	in. (mm)	4 (102)	4 <sup>5</sup> / <sub>8</sub> (117)	5 <sup>3</sup> / <sub>4</sub> (146)	4 <sup>5</sup> / <sub>8</sub> (117)	5 <sup>5</sup> / <sub>8</sub> (143)	6 <sup>3</sup> / <sub>8</sub> (162)	5 <sup>3</sup> / <sub>4</sub> (146)	6 <sup>3</sup> / <sub>4</sub> (171)	7 <sup>3</sup> / <sub>8</sub> (187)
UNCRACKED CONCRETE	Minimum edge and spacing Case 1 <sup>2</sup>	<i>c<sub>min,1</sub></i>	in. (mm)	3 <sup>1</sup> / <sub>8</sub> (79)	2 <sup>3</sup> / <sub>4</sub> (70)	2 <sup>1</sup> / <sub>4</sub> (57)	2 <sup>3</sup> / <sub>4</sub> (70)	2 <sup>1</sup> / <sub>4</sub> (57)	2 (51)	2 <sup>1</sup> / <sub>4</sub> (57)	1 <sup>7</sup> / <sub>8</sub> (48)	1 <sup>7</sup> / <sub>8</sub> (48)	
		<i>s<sub>min,1</sub></i>	in. (mm)	9 <sup>1</sup> / <sub>8</sub> (232)	7 <sup>3</sup> / <sub>4</sub> (197)	6 <sup>1</sup> / <sub>8</sub> (156)	7 <sup>3</sup> / <sub>4</sub> (197)	6 <sup>1</sup> / <sub>2</sub> (165)	5 <sup>5</sup> / <sub>8</sub> (143)	6 <sup>1</sup> / <sub>8</sub> (156)	5 <sup>3</sup> / <sub>8</sub> (137)	4 <sup>1</sup> / <sub>2</sub> (114)	
	Minimum edge and spacing Case 2 <sup>2</sup>	<i>c<sub>min,2</sub></i>	in. (mm)	5 <sup>5</sup> / <sub>8</sub> (143)	4 <sup>3</sup> / <sub>4</sub> (121)	3 <sup>3</sup> / <sub>4</sub> (95)	4 <sup>3</sup> / <sub>4</sub> (121)	3 <sup>7</sup> / <sub>8</sub> (98)	3 <sup>1</sup> / <sub>4</sub> (83)	3 <sup>3</sup> / <sub>4</sub> (95)	3 <sup>1</sup> / <sub>8</sub> (79)	2 <sup>3</sup> / <sub>4</sub> (70)	
		<i>s<sub>min,2</sub></i>	in. (mm)	1 <sup>7</sup> / <sub>8</sub> (48)	1 <sup>7</sup> / <sub>8</sub> (48)	1 <sup>7</sup> / <sub>8</sub> (48)	1 <sup>7</sup> / <sub>8</sub> (48)	1 <sup>7</sup> / <sub>8</sub> (48)	1 <sup>7</sup> / <sub>8</sub> (48)	1 <sup>7</sup> / <sub>8</sub> (48)	1 <sup>7</sup> / <sub>8</sub> (48)	1 <sup>7</sup> / <sub>8</sub> (48)	
CRACKED CONCRETE	Minimum edge and spacing Case 1 <sup>2</sup>	<i>c<sub>min,1</sub></i>	in. (mm)	2 <sup>1</sup> / <sub>8</sub> (54)	1 <sup>7</sup> / <sub>8</sub> (48)	1 <sup>7</sup> / <sub>8</sub> (48)	1 <sup>7</sup> / <sub>8</sub> (48)	1 <sup>7</sup> / <sub>8</sub> (48)	1 <sup>7</sup> / <sub>8</sub> (48)	1 <sup>7</sup> / <sub>8</sub> (48)	1 <sup>7</sup> / <sub>8</sub> (48)	1 <sup>7</sup> / <sub>8</sub> (48)	
		<i>s<sub>min,1</sub></i>	in. (mm)	6 <sup>3</sup> / <sub>8</sub> (162)	5 <sup>1</sup> / <sub>2</sub> (140)	4 <sup>1</sup> / <sub>4</sub> (108)	5 <sup>1</sup> / <sub>2</sub> (140)	3 <sup>1</sup> / <sub>2</sub> (89)	2 <sup>5</sup> / <sub>8</sub> (67)	3 <sup>1</sup> / <sub>4</sub> (83)	2 (51)	1 <sup>7</sup> / <sub>8</sub> (48)	
	Minimum edge and spacing Case 2 <sup>2</sup>	<i>c<sub>min,2</sub></i>	in. (mm)	3 <sup>5</sup> / <sub>8</sub> (92)	3 <sup>1</sup> / <sub>8</sub> (79)	2 <sup>3</sup> / <sub>8</sub> (60)	3 <sup>1</sup> / <sub>8</sub> (79)	2 <sup>1</sup> / <sub>2</sub> (64)	2 <sup>1</sup> / <sub>8</sub> (54)	2 <sup>3</sup> / <sub>8</sub> (60)	2 (51)	1 <sup>7</sup> / <sub>8</sub> (48)	
		<i>s<sub>min,2</sub></i>	in. (mm)	1 <sup>7</sup> / <sub>8</sub> (48)	1 <sup>7</sup> / <sub>8</sub> (48)	1 <sup>7</sup> / <sub>8</sub> (48)	1 <sup>7</sup> / <sub>8</sub> (48)	1 <sup>7</sup> / <sub>8</sub> (48)	1 <sup>7</sup> / <sub>8</sub> (48)	1 <sup>7</sup> / <sub>8</sub> (48)	1 <sup>7</sup> / <sub>8</sub> (48)	1 <sup>7</sup> / <sub>8</sub> (48)	

DESIGN INFORMATION			Symbol	Units	Nominal Rod Diameter (in.) – Fractional								
Rod O.D.			<i>d</i>	in. (mm)	<sup>1</sup> / <sub>2</sub> (12.7)								
Effective embedment			<i>h<sub>ef</sub></i>	in. (mm)	2- <sup>3</sup> / <sub>4</sub> (70)			4 <sup>1</sup> / <sub>2</sub> (114)		6 (152)			
Drilled hole condition <sup>1</sup>			-	-	2	1 or 2		2	1 or 2		2	1 or 2	
Minimum concrete thickness			<i>h</i>	in. (mm)	4 (102)	5 (127)	7 <sup>1</sup> / <sub>8</sub> (181)	5 <sup>3</sup> / <sub>4</sub> (146)	6 <sup>3</sup> / <sub>4</sub> (171)	8 <sup>1</sup> / <sub>4</sub> (210)	7 <sup>1</sup> / <sub>4</sub> (184)	8 <sup>1</sup> / <sub>4</sub> (210)	9 <sup>3</sup> / <sub>4</sub> (248)
UNCRACKED CONCRETE	Minimum edge and spacing Case 1 <sup>2</sup>	<i>c<sub>min,1</sub></i>	in. (mm)	5 <sup>1</sup> / <sub>8</sub> (130)	4 <sup>1</sup> / <sub>8</sub> (105)	2 <sup>7</sup> / <sub>8</sub> (73)	3 <sup>5</sup> / <sub>8</sub> (92)	3 (76)	2 <sup>1</sup> / <sub>2</sub> (64)	2 <sup>1</sup> / <sub>8</sub> (73)	2 <sup>1</sup> / <sub>2</sub> (64)	2 <sup>1</sup> / <sub>2</sub> (64)	
		<i>s<sub>min,1</sub></i>	in. (mm)	14 <sup>7</sup> / <sub>8</sub> (378)	11 <sup>7</sup> / <sub>8</sub> (302)	8 <sup>5</sup> / <sub>8</sub> (219)	10 <sup>1</sup> / <sub>4</sub> (260)	9 (229)	7 <sup>1</sup> / <sub>4</sub> (184)	8 <sup>1</sup> / <sub>8</sub> (206)	7 <sup>1</sup> / <sub>4</sub> (184)	5 (127)	
	Minimum edge and spacing Case 2 <sup>2</sup>	<i>c<sub>min,2</sub></i>	in. (mm)	9 <sup>1</sup> / <sub>4</sub> (235)	7 <sup>1</sup> / <sub>4</sub> (184)	4 <sup>7</sup> / <sub>8</sub> (124)	6 <sup>1</sup> / <sub>4</sub> (159)	5 <sup>1</sup> / <sub>4</sub> (133)	4 <sup>1</sup> / <sub>8</sub> (105)	4 <sup>1</sup> / <sub>4</sub> (121)	4 <sup>1</sup> / <sub>8</sub> (105)	3 <sup>3</sup> / <sub>8</sub> (86)	
		<i>s<sub>min,2</sub></i>	in. (mm)	2 <sup>1</sup> / <sub>2</sub> (64)	2 <sup>1</sup> / <sub>2</sub> (64)	2 <sup>1</sup> / <sub>2</sub> (64)	2 <sup>1</sup> / <sub>2</sub> (64)	2 <sup>1</sup> / <sub>2</sub> (64)	2 <sup>1</sup> / <sub>2</sub> (64)	2 <sup>1</sup> / <sub>2</sub> (64)	2 <sup>1</sup> / <sub>2</sub> (64)	2 <sup>1</sup> / <sub>2</sub> (64)	
CRACKED CONCRETE	Minimum edge and spacing Case 1 <sup>2</sup>	<i>c<sub>min,1</sub></i>	in. (mm)	3 <sup>5</sup> / <sub>8</sub> (92)	3 (76)	2 <sup>1</sup> / <sub>2</sub> (64)	2 <sup>5</sup> / <sub>8</sub> (67)	2 <sup>1</sup> / <sub>2</sub> (64)	2 <sup>1</sup> / <sub>2</sub> (64)	2 <sup>1</sup> / <sub>2</sub> (64)	2 <sup>1</sup> / <sub>2</sub> (64)	2 <sup>1</sup> / <sub>2</sub> (64)	
		<i>s<sub>min,1</sub></i>	in. (mm)	10 <sup>7</sup> / <sub>8</sub> (276)	8 <sup>1</sup> / <sub>2</sub> (216)	6 (152)	7 <sup>3</sup> / <sub>8</sub> (187)	5 <sup>1</sup> / <sub>2</sub> (140)	3 <sup>1</sup> / <sub>8</sub> (79)	4 <sup>1</sup> / <sub>2</sub> (114)	3 <sup>1</sup> / <sub>8</sub> (79)	2 <sup>1</sup> / <sub>2</sub> (64)	
	Minimum edge and spacing Case 2 <sup>2</sup>	<i>c<sub>min,2</sub></i>	in. (mm)	6 <sup>1</sup> / <sub>2</sub> (165)	5 (127)	3 <sup>1</sup> / <sub>4</sub> (83)	4 <sup>1</sup> / <sub>4</sub> (108)	3 <sup>1</sup> / <sub>2</sub> (89)	2 <sup>3</sup> / <sub>4</sub> (70)	3 <sup>1</sup> / <sub>4</sub> (83)	2 <sup>3</sup> / <sub>4</sub> (70)	2 <sup>1</sup> / <sub>2</sub> (64)	
		<i>s<sub>min,2</sub></i>	in. (mm)	2 <sup>1</sup> / <sub>2</sub> (64)	2 <sup>1</sup> / <sub>2</sub> (64)	2 <sup>1</sup> / <sub>2</sub> (64)	2 <sup>1</sup> / <sub>2</sub> (64)	2 <sup>1</sup> / <sub>2</sub> (64)	2 <sup>1</sup> / <sub>2</sub> (64)	2 <sup>1</sup> / <sub>2</sub> (64)	2 <sup>1</sup> / <sub>2</sub> (64)	2 <sup>1</sup> / <sub>2</sub> (64)	

DESIGN INFORMATION			Symbol	Units	Nominal Rod Diameter (in.) – Fractional								
Rod O.D.			<i>d</i>	in. (mm)	<sup>5</sup> / <sub>8</sub> (15.9)								
Effective embedment			<i>h<sub>ef</sub></i>	in. (mm)	3 <sup>3</sup> / <sub>4</sub> (95)			5 <sup>5</sup> / <sub>8</sub> (143)		7 <sup>1</sup> / <sub>2</sub> (191)			
Drilled hole condition <sup>1</sup>			-	-	2	1 or 2		2	1 or 2		2	1 or 2	
Minimum concrete thickness			<i>h</i>	in. (mm)	5 <sup>1</sup> / <sub>2</sub> (140)	7 <sup>3</sup> / <sub>4</sub> (197)	9 <sup>3</sup> / <sub>8</sub> (238)	7 <sup>3</sup> / <sub>8</sub> (187)	9 <sup>5</sup> / <sub>8</sub> (244)	10 <sup>1</sup> / <sub>2</sub> (267)	9 <sup>1</sup> / <sub>4</sub> (235)	11 <sup>1</sup> / <sub>2</sub> (292)	12 <sup>1</sup> / <sub>4</sub> (311)
UNCRACKED CONCRETE	Minimum edge and spacing Case 1 <sup>2</sup>	<i>c<sub>min,1</sub></i>	in. (mm)	6 <sup>1</sup> / <sub>4</sub> (159)	4 <sup>1</sup> / <sub>2</sub> (114)	3 <sup>3</sup> / <sub>4</sub> (95)	4 <sup>5</sup> / <sub>8</sub> (117)	3 <sup>5</sup> / <sub>8</sub> (92)	3 <sup>1</sup> / <sub>4</sub> (83)	3 <sup>3</sup> / <sub>4</sub> (95)	3 <sup>1</sup> / <sub>8</sub> (79)	3 <sup>1</sup> / <sub>8</sub> (79)	
		<i>s<sub>min,1</sub></i>	in. (mm)	18 <sup>3</sup> / <sub>8</sub> (467)	12 <sup>7</sup> / <sub>8</sub> (327)	10 <sup>5</sup> / <sub>8</sub> (270)	13 <sup>7</sup> / <sub>8</sub> (352)	10 <sup>3</sup> / <sub>8</sub> (264)	9 <sup>3</sup> / <sub>4</sub> (248)	10 <sup>7</sup> / <sub>8</sub> (276)	8 <sup>3</sup> / <sub>8</sub> (213)	7 <sup>3</sup> / <sub>8</sub> (187)	
	Minimum edge and spacing Case 2 <sup>2</sup>	<i>c<sub>min,2</sub></i>	in. (mm)	11 <sup>3</sup> / <sub>8</sub> (289)	7 <sup>3</sup> / <sub>4</sub> (197)	6 <sup>1</sup> / <sub>4</sub> (159)	8 <sup>1</sup> / <sub>4</sub> (210)	6 <sup>1</sup> / <sub>8</sub> (156)	5 <sup>1</sup> / <sub>2</sub> (140)	6 <sup>1</sup> / <sub>8</sub> (162)	4 <sup>7</sup> / <sub>8</sub> (124)	4 <sup>5</sup> / <sub>8</sub> (117)	
		<i>s<sub>min,2</sub></i>	in. (mm)	3 <sup>1</sup> / <sub>8</sub> (79)	3 <sup>1</sup> / <sub>8</sub> (79)	3 <sup>1</sup> / <sub>8</sub> (79)	3 <sup>1</sup> / <sub>8</sub> (79)	3 <sup>1</sup> / <sub>8</sub> (79)	3 <sup>1</sup> / <sub>8</sub> (79)	3 <sup>1</sup> / <sub>8</sub> (79)	3 <sup>1</sup> / <sub>8</sub> (79)	3 <sup>1</sup> / <sub>8</sub> (79)	
CRACKED CONCRETE	Minimum edge and spacing Case 1 <sup>2</sup>	<i>c<sub>min,1</sub></i>	in. (mm)	4 <sup>5</sup> / <sub>8</sub> (117)	3 <sup>3</sup> / <sub>8</sub> (86)	3 <sup>1</sup> / <sub>8</sub> (79)	3 <sup>1</sup> / <sub>2</sub> (89)	3 <sup>1</sup> / <sub>8</sub> (79)	3 <sup>1</sup> / <sub>8</sub> (79)	3 <sup>1</sup> / <sub>8</sub> (79)	3 <sup>1</sup> / <sub>8</sub> (79)	3 <sup>1</sup> / <sub>8</sub> (79)	
		<i>s<sub>min,1</sub></i>	in. (mm)	13 <sup>7</sup> / <sub>8</sub> (352)	9 <sup>1</sup> / <sub>2</sub> (241)	8 <sup>3</sup> / <sub>4</sub> (222)	10 <sup>1</sup> / <sub>8</sub> (257)	6 <sup>1</sup> / <sub>2</sub> (165)	5 <sup>3</sup> / <sub>8</sub> (137)	7 <sup>1</sup> / <sub>8</sub> (181)	3 <sup>1</sup> / <sub>8</sub> (98)	3 <sup>1</sup> / <sub>8</sub> (79)	
	Minimum edge and spacing Case 2 <sup>2</sup>	<i>c<sub>min,2</sub></i>	in. (mm)	8 <sup>1</sup> / <sub>4</sub> (210)	5 <sup>1</sup> / <sub>2</sub> (140)	4 <sup>3</sup> / <sub>8</sub> (111)	5 <sup>7</sup> / <sub>8</sub> (149)	4 <sup>1</sup> / <sub>4</sub> (108)	3 <sup>1</sup> / <sub>8</sub> (98)	4 <sup>1</sup> / <sub>2</sub> (114)	3 <sup>3</sup> / <sub>8</sub> (86)	3 <sup>1</sup> / <sub>8</sub> (79)	
		<i>s<sub>min,2</sub></i>	in. (mm)	3 <sup>1</sup> / <sub>8</sub> (79)	3 <sup>1</sup> / <sub>8</sub> (79)	3 <sup>1</sup> / <sub>8</sub> (79)	3 <sup>1</sup> / <sub>8</sub> (79)	3 <sup>1</sup> / <sub>8</sub> (79)	3 <sup>1</sup> / <sub>8</sub> (79)	3 <sup>1</sup> / <sub>8</sub> (79)	3 <sup>1</sup> / <sub>8</sub> (79)	3 <sup>1</sup> / <sub>8</sub> (79)	

For **SI**: 1 inch ≅ 25.4 mm

<sup>1</sup> See Figure 4 for description of drilled hole condition.

<sup>2</sup> Linear interpolation is permitted to establish an edge distance and spacing combination between case 1 and case 2.

Linear interpolation for a specific edge distance *c*, where *c<sub>min,1</sub>* < *c* < *c<sub>min,2</sub>*, will determine the permissible spacing, *s*, as follows:

$$s \geq s_{min,2} + \frac{(s_{min,1} - s_{min,2})}{(c_{min,1} - c_{min,2})} (c - c_{min,2})$$

**TABLE 9—PRE-CALCULATED EDGE DISTANCE AND SPACING COMBINATIONS FOR HILTI HIT-Z AND HIT-Z-R RODS (Continued)**

DESIGN INFORMATION			Symbol	Units	Nominal Rod Diameter (in.) – Fractional								
Rod O.D.			<i>d</i>	in. (mm)	<sup>3</sup> / <sub>4</sub> (19.1)								
Effective embedment			<i>h<sub>ef</sub></i>	in. (mm)	4 (102)			6 <sup>3</sup> / <sub>4</sub> (171)		8 <sup>1</sup> / <sub>2</sub> (216)			
Drilled hole condition <sup>1</sup>			-	-	2	1 or 2		2	1 or 2		2	1 or 2	
Minimum concrete thickness			<i>h</i>	in. (mm)	5 <sup>3</sup> / <sub>4</sub> (146)	8 (203)	11 <sup>1</sup> / <sub>2</sub> (292)	8 <sup>1</sup> / <sub>2</sub> (216)	10 <sup>3</sup> / <sub>4</sub> (273)	13 <sup>1</sup> / <sub>8</sub> (333)	10 <sup>1</sup> / <sub>4</sub> (260)	12 <sup>1</sup> / <sub>2</sub> (318)	14 <sup>1</sup> / <sub>2</sub> (368)
UNCRACKED CONCRETE	Minimum edge and spacing Case 1 <sup>2</sup>	<i>c<sub>min,1</sub></i>	in. (mm)	9 <sup>3</sup> / <sub>4</sub> (248)	7 (178)	5 (127)	6 <sup>5</sup> / <sub>8</sub> (168)	5 <sup>1</sup> / <sub>4</sub> (133)	4 <sup>1</sup> / <sub>4</sub> (108)	5 <sup>1</sup> / <sub>2</sub> (140)	4 <sup>1</sup> / <sub>2</sub> (114)	4 (102)	
		<i>s<sub>min,1</sub></i>	in. (mm)	28 <sup>3</sup> / <sub>4</sub> (730)	20 <sup>5</sup> / <sub>8</sub> (524)	14 (356)	19 <sup>3</sup> / <sub>8</sub> (492)	15 <sup>1</sup> / <sub>4</sub> (387)	12 <sup>5</sup> / <sub>8</sub> (321)	16 (406)	13 <sup>1</sup> / <sub>4</sub> (337)	11 (279)	
	Minimum edge and spacing Case 2 <sup>2</sup>	<i>c<sub>min,2</sub></i>	in. (mm)	18 <sup>1</sup> / <sub>8</sub> (460)	12 <sup>5</sup> / <sub>8</sub> (321)	8 <sup>1</sup> / <sub>2</sub> (216)	11 <sup>1</sup> / <sub>8</sub> (302)	9 <sup>1</sup> / <sub>8</sub> (232)	7 <sup>1</sup> / <sub>4</sub> (184)	9 <sup>1</sup> / <sub>8</sub> (244)	7 <sup>3</sup> / <sub>4</sub> (197)	6 <sup>1</sup> / <sub>2</sub> (165)	
		<i>s<sub>min,2</sub></i>	in. (mm)	3 <sup>3</sup> / <sub>4</sub> (95)	3 <sup>3</sup> / <sub>4</sub> (95)	3 <sup>3</sup> / <sub>4</sub> (95)	3 <sup>3</sup> / <sub>4</sub> (95)	3 <sup>3</sup> / <sub>4</sub> (95)	3 <sup>3</sup> / <sub>4</sub> (95)	3 <sup>3</sup> / <sub>4</sub> (95)	3 <sup>3</sup> / <sub>4</sub> (95)	3 <sup>3</sup> / <sub>4</sub> (95)	3 <sup>3</sup> / <sub>4</sub> (95)
CRACKED CONCRETE	Minimum edge and spacing Case 1 <sup>2</sup>	<i>c<sub>min,1</sub></i>	in. (mm)	7 <sup>1</sup> / <sub>4</sub> (184)	5 <sup>1</sup> / <sub>4</sub> (133)	4 <sup>1</sup> / <sub>8</sub> (105)	5 (127)	4 (102)	3 <sup>3</sup> / <sub>4</sub> (95)	4 <sup>1</sup> / <sub>8</sub> (105)	3 <sup>3</sup> / <sub>4</sub> (95)	3 <sup>3</sup> / <sub>4</sub> (95)	
		<i>s<sub>min,1</sub></i>	in. (mm)	21 <sup>3</sup> / <sub>4</sub> (552)	15 <sup>1</sup> / <sub>2</sub> (394)	12 <sup>1</sup> / <sub>4</sub> (311)	14 <sup>1</sup> / <sub>2</sub> (368)	11 <sup>3</sup> / <sub>8</sub> (289)	9 (229)	12 <sup>1</sup> / <sub>8</sub> (308)	8 <sup>3</sup> / <sub>4</sub> (222)	6 <sup>1</sup> / <sub>2</sub> (165)	
	Minimum edge and spacing Case 2 <sup>2</sup>	<i>c<sub>min,2</sub></i>	in. (mm)	13 <sup>1</sup> / <sub>4</sub> (337)	9 <sup>1</sup> / <sub>4</sub> (235)	6 (152)	8 <sup>5</sup> / <sub>8</sub> (219)	6 <sup>5</sup> / <sub>8</sub> (168)	5 <sup>1</sup> / <sub>8</sub> (130)	7 (178)	5 <sup>1</sup> / <sub>2</sub> (140)	4 <sup>1</sup> / <sub>2</sub> (114)	
		<i>s<sub>min,2</sub></i>	in. (mm)	3 <sup>3</sup> / <sub>4</sub> (95)	3 <sup>3</sup> / <sub>4</sub> (95)	3 <sup>3</sup> / <sub>4</sub> (95)	3 <sup>3</sup> / <sub>4</sub> (95)	3 <sup>3</sup> / <sub>4</sub> (95)	3 <sup>3</sup> / <sub>4</sub> (95)	3 <sup>3</sup> / <sub>4</sub> (95)	3 <sup>3</sup> / <sub>4</sub> (95)	3 <sup>3</sup> / <sub>4</sub> (95)	

DESIGN INFORMATION			Symbol	Units	Nominal Rod Diameter (mm) – Metric								
Rod O.D.			<i>d</i>	mm (in.)	10 (0.39)								
Effective embedment			<i>h<sub>ef</sub></i>	mm (in.)	60 (2.36)			90 (3.54)		120 (4.72)			
Drilled hole condition <sup>1</sup>			-	-	2	1 or 2		2	1 or 2		2	1 or 2	
Minimum concrete thickness			<i>h</i>	mm (in.)	100 (3.94)	120 (4.72)	156 (6.14)	120 (4.72)	150 (5.91)	176 (6.91)	150 (5.91)	180 (7.09)	197 (7.74)
UNCRACKED CONCRETE	Minimum edge and spacing Case 1 <sup>2</sup>	<i>c<sub>min,1</sub></i>	mm (in.)	99 (3.90)	83 (3.27)	64 (2.52)	83 (3.27)	66 (2.60)	57 (2.24)	66 (2.60)	55 (2.17)	51 (2.01)	
		<i>s<sub>min,1</sub></i>	mm (in.)	295 (11.61)	244 (9.61)	187 (7.36)	244 (9.61)	197 (7.76)	166 (6.54)	197 (7.76)	164 (6.46)	148 (5.83)	
	Minimum edge and spacing Case 2 <sup>2</sup>	<i>c<sub>min,2</sub></i>	mm (in.)	181 (7.13)	148 (5.83)	110 (4.33)	148 (5.83)	115 (4.53)	96 (3.78)	115 (4.53)	93 (3.66)	84 (3.31)	
		<i>s<sub>min,2</sub></i>	mm (in.)	50 (1.97)	50 (1.97)	50 (1.97)	50 (1.97)	50 (1.97)	50 (1.97)	50 (1.97)	50 (1.97)	50 (1.97)	
CRACKED CONCRETE	Minimum edge and spacing Case 1 <sup>2</sup>	<i>c<sub>min,1</sub></i>	mm (in.)	71 (2.80)	59 (2.32)	52 (2.05)	59 (2.32)	50 (1.97)	50 (1.97)	50 (1.97)	50 (1.97)	50 (1.97)	
		<i>s<sub>min,1</sub></i>	mm (in.)	209 (8.23)	174 (6.85)	150 (5.91)	174 (6.85)	131 (5.16)	106 (4.17)	131 (5.16)	84 (3.31)	66 (2.60)	
	Minimum edge and spacing Case 2 <sup>2</sup>	<i>c<sub>min,2</sub></i>	mm (in.)	124 (4.88)	101 (3.98)	74 (2.91)	101 (3.98)	77 (3.03)	64 (2.52)	77 (3.03)	62 (2.44)	55 (2.17)	
		<i>s<sub>min,2</sub></i>	mm (in.)	50 (1.97)	50 (1.97)	50 (1.97)	50 (1.97)	50 (1.97)	50 (1.97)	50 (1.97)	50 (1.97)	50 (1.97)	

DESIGN INFORMATION			Symbol	Units	Nominal Rod Diameter (mm) – Metric								
Rod O.D.			<i>d</i>	mm (in.)	12 (0.47)								
Effective embedment			<i>h<sub>ef</sub></i>	mm (in.)	70 (2.76)			108 (4.25)		144 (5.67)			
Drilled hole condition <sup>1</sup>			-	-	2	1 or 2		2	1 or 2		2	1 or 2	
Minimum concrete thickness			<i>h</i>	mm (in.)	100 (3.94)	130 (5.12)	184 (7.24)	138 (5.43)	168 (6.61)	209 (8.21)	174 (6.85)	204 (8.03)	234 (9.21)
UNCRACKED CONCRETE	Minimum edge and spacing Case 1 <sup>2</sup>	<i>c<sub>min,1</sub></i>	mm (in.)	139 (5.47)	107 (4.21)	76 (2.99)	101 (3.98)	83 (3.27)	67 (2.64)	80 (3.15)	68 (2.68)	60 (2.36)	
		<i>s<sub>min,1</sub></i>	mm (in.)	416 (16.38)	320 (12.60)	225 (8.86)	300 (11.81)	247 (9.72)	199 (7.83)	239 (9.41)	204 (8.03)	176 (6.93)	
	Minimum edge and spacing Case 2 <sup>2</sup>	<i>c<sub>min,2</sub></i>	mm (in.)	258 (10.16)	194 (7.64)	131 (5.16)	181 (7.13)	146 (5.75)	114 (4.49)	140 (5.51)	116 (4.57)	99 (3.90)	
		<i>s<sub>min,2</sub></i>	mm (in.)	60 (2.36)	60 (2.36)	60 (2.36)	60 (2.36)	60 (2.36)	60 (2.36)	60 (2.36)	60 (2.36)	60 (2.36)	
CRACKED CONCRETE	Minimum edge and spacing Case 1 <sup>2</sup>	<i>c<sub>min,1</sub></i>	mm (in.)	101 (3.98)	78 (3.07)	62 (2.44)	74 (2.91)	61 (2.40)	60 (2.36)	60 (2.36)	60 (2.36)	60 (2.36)	
		<i>s<sub>min,1</sub></i>	mm (in.)	303 (11.93)	232 (9.13)	186 (7.32)	217 (8.54)	178 (7.01)	126 (4.96)	168 (6.61)	117 (4.61)	79 (3.11)	
	Minimum edge and spacing Case 2 <sup>2</sup>	<i>c<sub>min,2</sub></i>	mm (in.)	182 (7.17)	136 (5.35)	90 (3.54)	127 (5.00)	101 (3.98)	77 (3.03)	96 (3.78)	79 (3.11)	67 (2.64)	
		<i>s<sub>min,2</sub></i>	mm (in.)	60 (2.36)	60 (2.36)	60 (2.36)	60 (2.36)	60 (2.36)	60 (2.36)	60 (2.36)	60 (2.36)	60 (2.36)	

For **SI**: 1 inch ≅ 25.4 mm

<sup>1</sup> See Figure 4 for description of drilled hole condition.

<sup>2</sup> Linear interpolation is permitted to establish an edge distance and spacing combination between case 1 and case 2.

Linear interpolation for a specific edge distance *c*, where *c<sub>min,1</sub>* < *c* < *c<sub>min,2</sub>*, will determine the permissible spacing, *s*, as follows:

$$s \geq s_{min,2} + \left( \frac{s_{min,1} - s_{min,2}}{c_{min,1} - c_{min,2}} \right) (c - c_{min,2})$$

**TABLE 9—PRE-CALCULATED EDGE DISTANCE AND SPACING COMBINATIONS FOR HILTI HIT-Z AND HIT-Z-R RODS (Continued)**

DESIGN INFORMATION			Symbol	Units	Nominal Rod Diameter (mm) – Metric								
Rod O.D.			<i>d</i>	mm (in.)	16 (0.63)								
Effective embedment			<i>h<sub>ef</sub></i>	mm (in.)	96 (3.78)			144 (5.67)		192 (7.56)			
Drilled hole condition <sup>1</sup>			-	-	2	1 or 2		2	1 or 2		2	1 or 2	
Minimum concrete thickness			<i>h</i>	mm (in.)	141 (5.55)	196 (7.72)	237 (9.33)	189 (7.44)	244 (9.61)	269 (10.57)	237 (9.33)	292 (11.50)	312 (12.28)
UNCRACKED CONCRETE	Minimum edge and spacing Case 1 <sup>2</sup>	<i>c<sub>min,1</sub></i>	mm (in.)	158 (6.22)	114 (4.49)	94 (3.70)	118 (4.65)	92 (3.62)	83 (3.27)	94 (3.70)	80 (3.15)	80 (3.15)	
		<i>s<sub>min,1</sub></i>	mm (in.)	473 (18.62)	339 (13.35)	281 (11.06)	352 (13.86)	271 (10.67)	248 (9.76)	281 (11.06)	217 (8.54)	188 (7.40)	
	Minimum edge and spacing Case 2 <sup>2</sup>	<i>c<sub>min,2</sub></i>	mm (in.)	289 (11.38)	201 (7.91)	161 (6.34)	209 (8.23)	156 (6.14)	139 (5.47)	161 (6.34)	126 (4.96)	116 (4.57)	
		<i>s<sub>min,2</sub></i>	mm (in.)	80 (3.15)	80 (3.15)	80 (3.15)	80 (3.15)	80 (3.15)	80 (3.15)	80 (3.15)	80 (3.15)	80 (3.15)	80 (3.15)
CRACKED CONCRETE	Minimum edge and spacing Case 1 <sup>2</sup>	<i>c<sub>min,1</sub></i>	mm (in.)	116 (4.57)	83 (3.27)	80 (3.15)	86 (3.39)	80 (3.15)	80 (3.15)	80 (3.15)	80 (3.15)	80 (3.15)	
		<i>s<sub>min,1</sub></i>	mm (in.)	343 (13.50)	248 (9.76)	211 (8.31)	258 (10.16)	160 (6.30)	129 (5.08)	171 (6.73)	94 (3.70)	81 (3.19)	
	Minimum edge and spacing Case 2 <sup>2</sup>	<i>c<sub>min,2</sub></i>	mm (in.)	204 (8.03)	139 (5.47)	111 (4.37)	146 (5.75)	107 (4.21)	95 (3.74)	111 (4.37)	85 (3.35)	80 (3.15)	
		<i>s<sub>min,2</sub></i>	mm (in.)	80 (3.15)	80 (3.15)	80 (3.15)	80 (3.15)	80 (3.15)	80 (3.15)	80 (3.15)	80 (3.15)	80 (3.15)	80 (3.15)

DESIGN INFORMATION			Symbol	Units	Nominal Rod Diameter (mm) – Metric								
Rod O.D.			<i>d</i>	mm (in.)	20 (0.79)								
Effective embedment			<i>h<sub>ef</sub></i>	mm (in.)	100 (3.94)			180 (7.09)		220 (8.66)			
Drilled hole condition <sup>1</sup>			-	-	2	1 or 2		2	1 or 2		2	1 or 2	
Minimum concrete thickness			<i>h</i>	mm (in.)	145 (5.71)	200 (7.87)	282 (11.08)	225 (8.86)	280 (11.02)	335 (13.17)	265 (10.43)	320 (12.60)	370 (14.57)
UNCRACKED CONCRETE	Minimum edge and spacing Case 1 <sup>2</sup>	<i>c<sub>min,1</sub></i>	mm (in.)	235 (9.25)	170 (6.69)	121 (4.76)	152 (5.98)	122 (4.80)	103 (4.06)	129 (5.08)	107 (4.21)	100 (3.94)	
		<i>s<sub>min,1</sub></i>	mm (in.)	702 (27.64)	511 (20.12)	362 (14.25)	451 (17.76)	363 (14.29)	301 (11.85)	383 (15.08)	317 (12.48)	252 (9.92)	
	Minimum edge and spacing Case 2 <sup>2</sup>	<i>c<sub>min,2</sub></i>	mm (in.)	436 (17.17)	307 (12.09)	209 (8.23)	269 (10.59)	210 (8.27)	170 (6.69)	224 (8.82)	180 (7.09)	151 (5.94)	
		<i>s<sub>min,2</sub></i>	mm (in.)	100 (3.94)	100 (3.94)	100 (3.94)	100 (3.94)	100 (3.94)	100 (3.94)	100 (3.94)	100 (3.94)	100 (3.94)	100 (3.94)
CRACKED CONCRETE	Minimum edge and spacing Case 1 <sup>2</sup>	<i>c<sub>min,1</sub></i>	mm (in.)	176 (6.93)	128 (5.04)	102 (4.02)	114 (4.49)	100 (3.94)	100 (3.94)	100 (3.94)	100 (3.94)	100 (3.94)	
		<i>s<sub>min,1</sub></i>	mm (in.)	526 (20.71)	380 (14.96)	298 (11.73)	337 (13.27)	246 (9.69)	163 (6.42)	277 (10.91)	178 (7.01)	113 (4.45)	
	Minimum edge and spacing Case 2 <sup>2</sup>	<i>c<sub>min,2</sub></i>	mm (in.)	318 (12.52)	222 (8.74)	148 (5.83)	193 (7.60)	149 (5.87)	119 (4.69)	159 (6.26)	126 (4.96)	105 (4.13)	
		<i>s<sub>min,2</sub></i>	mm (in.)	100 (3.94)	100 (3.94)	100 (3.94)	100 (3.94)	100 (3.94)	100 (3.94)	100 (3.94)	100 (3.94)	100 (3.94)	100 (3.94)

For **SI**: 1 inch ≅ 25.4 mm

<sup>1</sup> See Figure 4 for description of drilled hole condition.

<sup>2</sup> Linear interpolation is permitted to establish an edge distance and spacing combination between case 1 and case 2.

Linear interpolation for a specific edge distance *c*, where *c<sub>min,1</sub>* < *c* < *c<sub>min,2</sub>*, will determine the permissible spacing, *s*, as follows:

$$s \geq s_{min,2} + \frac{(s_{min,1} - s_{min,2})}{(c_{min,1} - c_{min,2})} (c - c_{min,2})$$

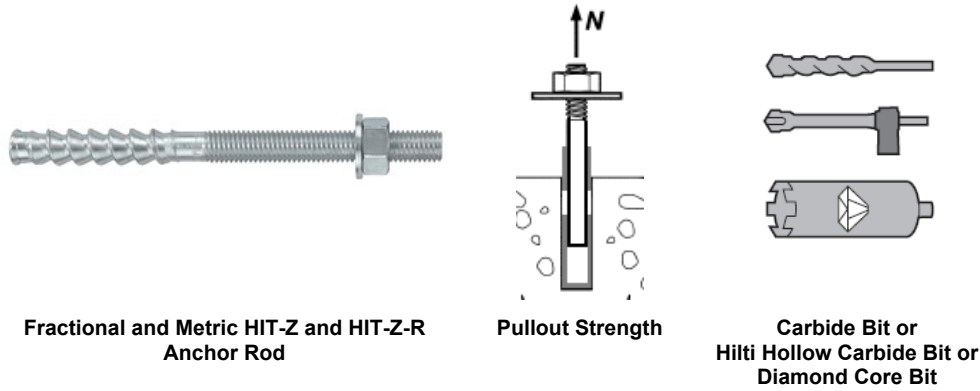

**TABLE 10—PULLOUT STRENGTH DESIGN INFORMATION FOR FRACTIONAL AND METRIC HILTI HIT-Z AND HIT-Z-R RODS IN HOLES DRILLED WITH A HAMMER DRILL AND CARBIDE BIT (OR HILTI HOLLOW CARBIDE DRILL BIT) OR A CORE DRILL<sup>1</sup>**

DESIGN INFORMATION		Symbol	Units	Nominal Rod Dia. (in.) Fractional				Units	Nominal Rod Dia. (mm) Metric			
				<sup>3</sup> / <sub>8</sub>	<sup>1</sup> / <sub>2</sub>	<sup>5</sup> / <sub>8</sub>	<sup>3</sup> / <sub>4</sub>		10	12	16	20
Minimum embedment depth		$h_{ef,min}$	in. (mm)	2 <sup>3</sup> / <sub>8</sub> (60)	2 <sup>3</sup> / <sub>4</sub> (70)	3 <sup>3</sup> / <sub>4</sub> (95)	4 (102)	mm (in.)	60 (2.4)	70 (2.8)	96 (3.8)	100 (3.9)
Maximum embedment depth		$h_{ef,max}$	in. (mm)	4 <sup>1</sup> / <sub>2</sub> (114)	6 (152)	7 <sup>1</sup> / <sub>2</sub> (190)	8 <sup>1</sup> / <sub>2</sub> (216)	mm (in.)	120 (4.7)	144 (5.7)	192 (7.6)	220 (8.7)
Temperature range A <sup>2</sup>	Pullout strength in cracked concrete	$N_{p,cr}$	lb (kN)	7,952 (35.4)	10,936 (48.6)	21,391 (95.1)	27,930 (124.2)	kN (lb)	39.1 (8,790)	43.8 (9,847)	98.0 (22,032)	127.9 (28,754)
	Pullout strength in uncracked concrete	$N_{p,uncr}$	lb (kN)	7,952 (35.4)	11,719 (52.1)	21,391 (95.1)	28,460 (126.6)	kN (lb)	39.1 (8,790)	46.9 (10,545)	98.0 (22,028)	130.3 (29,293)
Temperature range B <sup>2</sup>	Pullout strength in cracked concrete	$N_{p,cr}$	lb (kN)	7,952 (35.4)	10,936 (48.6)	21,391 (95.1)	27,930 (124.2)	kN (lb)	39.1 (8,790)	43.8 (9,847)	98.0 (22,032)	127.9 (28,754)
	Pullout strength in uncracked concrete	$N_{p,uncr}$	lb (kN)	7,952 (35.4)	11,719 (52.1)	21,391 (95.1)	28,460 (126.6)	kN (lb)	39.1 (8,790)	46.9 (10,545)	98.0 (22,028)	130.3 (29,293)
Temperature range C <sup>2</sup>	Pullout strength in cracked concrete	$N_{p,cr}$	lb (kN)	7,182 (31.9)	9,877 (43.9)	19,321 (85.9)	25,227 (112.2)	kN (lb)	35.3 (7,936)	39.5 (8,880)	88.5 (19,897)	115.5 (25,967)
	Pullout strength in uncracked concrete	$N_{p,uncr}$	lb (kN)	7,182 (31.9)	10,585 (47.1)	19,321 (85.9)	25,705 (114.3)	kN (lb)	35.3 (7,936)	42.4 (9,532)	88.5 (19,897)	117.7 (26,461)
Permissible installation conditions	Dry concrete, water saturated concrete	Anchor Category	-	1				-	1			
		$\phi_d, \phi_{ws}$	-	0.65				-	0.65			
Reduction for seismic tension		$\alpha_{N,seis}$	-	0.94	1.0			-	1.0	0.89	1.0	

For SI: 1 inch ≡ 25.4 mm, 1 lbf = 4.448 N, 1 psi = 0.006897 MPa.  
 For pound-inch units: 1 mm = 0.03937 inches, 1 N = 0.2248 lbf, 1 MPa = 145.0 psi

<sup>1</sup> Temperature range A: Maximum short term temperature = 130°F (55°C), Maximum long term temperature = 110°F (43°C).  
 Temperature range B: Maximum short term temperature = 176°F (80°C), Maximum long term temperature = 110°F (43°C).  
 Temperature range C: Maximum short term temperature = 248°F (120°C), Maximum long term temperature = 162°F (72°C).  
 Short term elevated concrete temperatures are those that occur over brief intervals, e.g., as a result of diurnal cycling. Long term concrete temperatures are roughly constant over significant periods of time.





Fractional Threaded Rod

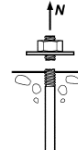

Steel Strength

TABLE 11—STEEL DESIGN INFORMATION FOR FRACTIONAL THREADED ROD

DESIGN INFORMATION		Symbol	Units	Nominal rod diameter (in.) <sup>1</sup>						
				3/8	1/2	5/8	3/4	7/8	1	1 1/4
Rod O.D.		<i>d</i>	in. (mm)	0.375 (9.5)	0.5 (12.7)	0.625 (15.9)	0.75 (19.1)	0.875 (22.2)	1 (25.4)	1.25 (31.8)
Rod effective cross-sectional area		<i>A<sub>se</sub></i>	in. <sup>2</sup> (mm <sup>2</sup> )	0.0775 (50)	0.1419 (92)	0.2260 (146)	0.3345 (216)	0.4617 (298)	0.6057 (391)	0.9691 (625)
ISO 898-1 Class 5.8	Nominal strength as governed by steel strength	<i>N<sub>sa</sub></i>	lb (kN)	5,620 (25.0)	10,290 (45.8)	16,385 (72.9)	24,250 (107.9)	33,470 (148.9)	43,910 (195.3)	70,260 (312.5)
		<i>V<sub>sa</sub></i>	lb (kN)	3,370 (15.0)	6,175 (27.5)	9,830 (43.7)	14,550 (64.7)	20,085 (89.3)	26,345 (117.2)	42,155 (187.5)
	Reduction for seismic shear	$\alpha_{V,seis}$	-	1.00						
	Strength reduction factor $\phi$ for tension <sup>2</sup>	$\phi$	-	0.65						
		Strength reduction factor $\phi$ for shear <sup>2</sup>	$\phi$	0.60						
ASTM A193 B7	Nominal strength as governed by steel strength	<i>N<sub>sa</sub></i>	lb (kN)	9,685 (43.1)	17,735 (78.9)	28,250 (125.7)	41,810 (186.0)	57,710 (256.7)	75,710 (336.8)	121,135 (538.8)
		<i>V<sub>sa</sub></i>	lb (kN)	5,810 (25.9)	10,640 (47.3)	16,950 (75.4)	25,085 (111.6)	34,625 (154.0)	45,425 (202.1)	72,680 (323.3)
	Reduction for seismic shear	$\alpha_{V,seis}$	-	1.00						
	Strength reduction factor $\phi$ for tension <sup>2</sup>	$\phi$	-	0.75						
		Strength reduction factor $\phi$ for shear <sup>2</sup>	$\phi$	0.65						
ASTM F1554 Gr. 36	Nominal strength as governed by steel strength	<i>N<sub>sa</sub></i>	lb (kN)	- (-)	8,230 (36.6)	13,110 (58.3)	19,400 (86.3)	26,780 (119.1)	35,130 (156.3)	56,210 (250.0)
		<i>V<sub>sa</sub></i>	lb (kN)	- (-)	4,940 (22.0)	7,865 (35.0)	11,640 (51.8)	16,070 (71.5)	21,080 (93.8)	33,725 (150.0)
	Reduction factor, seismic shear	$\alpha_{V,seis}$	-	0.6						
	Strength reduction factor $\phi$ for tension <sup>2</sup>	$\phi$	-	0.75						
		Strength reduction factor $\phi$ for shear <sup>2</sup>	$\phi$	0.65						
ASTM F1554 Gr. 55	Nominal strength as governed by steel strength	<i>N<sub>sa</sub></i>	lb (kN)	- (-)	10,645 (47.4)	16,950 (75.4)	25,090 (111.6)	34,630 (154.0)	45,430 (202.1)	72,685 (323.3)
		<i>V<sub>sa</sub></i>	lb (kN)	- (-)	6,385 (28.4)	10,170 (45.2)	15,055 (67.0)	20,780 (92.4)	27,260 (121.3)	43,610 (194.0)
	Reduction factor, seismic shear	$\alpha_{V,seis}$	-	1.00						
	Strength reduction factor $\phi$ for tension <sup>2</sup>	$\phi$	-	0.75						
		Strength reduction factor $\phi$ for shear <sup>2</sup>	$\phi$	0.65						
ASTM F1554 Gr. 105	Nominal strength as governed by steel strength	<i>N<sub>sa</sub></i>	lb (kN)	- (-)	17,740 (78.9)	28,250 (125.7)	41,815 (186.0)	57,715 (256.7)	75,715 (336.8)	121,135 (538.8)
		<i>V<sub>sa</sub></i>	lb (kN)	- (-)	10,645 (47.4)	16,950 (75.4)	25,090 (111.6)	34,630 (154.0)	45,430 (202.1)	72,680 (323.3)
	Reduction factor, seismic shear	$\alpha_{V,seis}$	-	1.00						
	Strength reduction factor $\phi$ for tension <sup>2</sup>	$\phi$	-	0.75						
		Strength reduction factor $\phi$ for shear <sup>2</sup>	$\phi$	0.65						
ASTM F593, CW Stainless	Nominal strength as governed by steel strength	<i>N<sub>sa</sub></i>	lb (kN)	7,750 (34.5)	14,190 (63.1)	22,600 (100.5)	28,435 (126.5)	39,245 (174.6)	51,485 (229.0)	- (-)
		<i>V<sub>sa</sub></i>	lb (kN)	4,650 (20.7)	8,515 (37.9)	13,560 (60.3)	17,060 (75.9)	23,545 (104.7)	30,890 (137.4)	- (-)
	Reduction factor, seismic shear	$\alpha_{V,seis}$	-	0.80						
	Strength reduction factor $\phi$ for tension <sup>2</sup>	$\phi$	-	0.65						
		Strength reduction factor $\phi$ for shear <sup>2</sup>	$\phi$	0.60						
ASTM A193, Gr. 8(M), Class 1 Stainless	Nominal strength as governed by steel strength	<i>N<sub>sa</sub></i>	lb (kN)	- (-)	- (-)	- (-)	- (-)	- (-)	- (-)	55,240 (245.7)
		<i>V<sub>sa</sub></i>	lb (kN)	- (-)	- (-)	- (-)	- (-)	- (-)	- (-)	33,145 (147.4)
	Reduction factor, seismic shear	$\alpha_{V,seis}$	-	0.80						
	Strength reduction factor $\phi$ for tension <sup>2</sup>	$\phi$	-	0.75						
		Strength reduction factor $\phi$ for shear <sup>2</sup>	$\phi$	0.65						

For **SI**: 1 inch = 25.4 mm, 1 lbf = 4.448 N. For **pound-inch** units: 1 mm = 0.03937 inches, 1 N = 0.2248 lbf

<sup>1</sup> Values provided for common rod material types are based on specified strengths and calculated in accordance with ACI 318-19 Eq. (17.6.1.2) and Eq. (17.7.1.2b), ACI 318-14 Eq. (17.4.1.2) and Eq. (17.5.1.2b) or ACI 318-11 Eq. (D-2) and Eq. (D-29). Nuts and washers must be appropriate for the rod.

<sup>2</sup> The strength reduction factor applies when the load combinations from the IBC or ACI 318 are used and the requirements of ACI 318-19 17.5.3, ACI 318-14 17.3.3 or ACI 318-11 D.4.3, as applicable, are met. If the load combinations of ACI 318-11 Appendix C are used, the appropriate strength reduction factor must be determined in accordance with ACI 318-11 D.4.4.



Fractional Reinforcing Bars

Steel Strength

TABLE 11A—STEEL DESIGN INFORMATION FOR FRACTIONAL REINFORCING BARS

DESIGN INFORMATION		Symbol	Units	Nominal Reinforcing bar size (Rebar)							
				#3	#4	#5	#6	#7	#8	#9	#10
Nominal bar diameter		$d$	in. (mm)	$\frac{3}{8}$ (9.5)	$\frac{1}{2}$ (12.7)	$\frac{5}{8}$ (15.9)	$\frac{3}{4}$ (19.1)	$\frac{7}{8}$ (22.2)	1 (25.4)	1.128 (28.7)	1.270 (32.3)
Bar effective cross-sectional area		$A_{se}$	in. <sup>2</sup> (mm <sup>2</sup> )	0.11 (71)	0.2 (129)	0.31 (199)	0.44 (284)	0.6 (387)	0.79 (510)	1.0 (645)	1.27 (819)
ASTM A615 Grade 60	Nominal strength as governed by steel strength	$N_{sa}$	lb (kN)	6,600 (29.4)	12,000 (53.4)	18,600 (82.7)	26,400 (117.4)	36,000 (160.1)	47,400 (210.9)	60,000 (266.9)	76,200 (339.0)
		$V_{sa}$	lb (kN)	3,960 (17.6)	7,200 (32.0)	11,160 (49.6)	15,840 (70.5)	21,600 (96.1)	28,440 (126.5)	36,000 (160.1)	45,720 (203.4)
	Reduction for seismic shear	$\alpha_{V,seis}$	-	0.70							
	Strength reduction factor $\phi$ for tension <sup>2</sup>	$\phi$	-	0.65							
	Strength reduction factor $\phi$ for shear <sup>2</sup>	$\phi$	-	0.60							
ASTM A615 Grade 60	Nominal strength as governed by steel strength	$N_{sa}$	lb (kN)	8,800 (39.1)	16,000 (71.2)	24,800 (110.3)	35,200 (156.6)	48,000 (213.5)	63,200 (281.1)	80,000 (355.9)	101,600 (451.9)
		$V_{sa}$	lb (kN)	5,280 (23.5)	9,600 (42.7)	14,880 (66.2)	21,120 (93.9)	28,800 (128.1)	37,920 (168.7)	48,000 (213.5)	60,960 (271.2)
	Reduction for seismic shear	$\alpha_{V,seis}$	-	0.70							
	Strength reduction factor $\phi$ for tension <sup>2</sup>	$\phi$	-	0.65							
	Strength reduction factor $\phi$ for shear <sup>2</sup>	$\phi$	-	0.60							
ASTM A706 Grade 60	Nominal strength as governed by steel strength	$N_{sa}$	lb (kN)	8,800 (39.1)	16,000 (71.2)	24,800 (110.3)	35,200 (156.6)	48,000 (213.5)	63,200 (281.1)	80,000 (355.9)	101,600 (452.0)
		$V_{sa}$	lb (kN)	5,280 (23.5)	9,600 (42.7)	14,880 (66.2)	21,120 (94.0)	28,800 (128.1)	37,920 (168.7)	48,000 (213.5)	60,960 (271.2)
	Reduction for seismic shear	$\alpha_{V,seis}$		0.70							
	Strength reduction factor $\phi$ for tension <sup>2</sup>	$\phi$		0.75							
	Strength reduction factor $\phi$ for shear <sup>2</sup>	$\phi$		0.65							

For SI: 1 inch = 25.4 mm, 1 lbf = 4.448 N. For pound-inch units: 1 mm = 0.03937 inches, 1 N = 0.2248 lbf

<sup>1</sup> Values provided for common rod material types are based on specified strengths and calculated in accordance with ACI 318-19 Eq. (17.6.1.2) and Eq (17.7.1.2b), ACI 318-14 Eq. (17.4.1.2) and Eq (17.5.1.2b) or ACI 318-11 Eq. (D-2) and Eq. (D-29). Nuts and washers must be appropriate for the rod.

<sup>2</sup> The strength reduction factor applies when the load combinations from the IBC or ACI 318 are used and the requirements of ACI 318-19 17.5.3, ACI 318-14 17.3.3 or ACI 318-11 D.4.3, as applicable, are met. If the load combinations of ACI 318-11 Appendix C are used, the appropriate strength reduction factor must be determined in accordance with ACI 318-11 D.4.4.



Fractional Threaded Rod and Reinforcing Bars

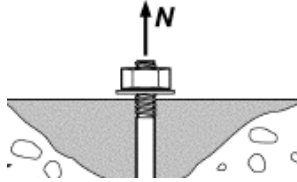

Concrete Breakout Strength

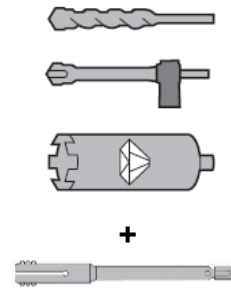

Carbide Bit or Hilti Hollow Carbide Bit or Diamond Core Bit with Roughening Tool

**TABLE 12—CONCRETE BREAKOUT DESIGN INFORMATION FOR FRACTIONAL THREADED ROD AND REINFORCING BARS IN HOLES DRILLED WITH A HAMMER DRILL AND CARBIDE BIT (OR HILTI HOLLOW CARBIDE DRILL BIT) OR CORE DRILLED WITH A DIAMOND CORE BIT AND ROUGHENED WITH A HILTI ROUGHENING TOOL<sup>1</sup>**

DESIGN INFORMATION	Symbol	Units	Nominal rod diameter (in.) / Reinforcing bar size							
			3/8 or #3	1/2 or #4	5/8 or #5	3/4 or #6	7/8 or #7	1 or #8	#9	1 1/4 or #10
Effectiveness factor for cracked concrete	$k_{c,cr}$	in-lb (SI)	17 (7.1)							
Effectiveness factor for uncracked concrete	$k_{c,uncr}$	in-lb (SI)	24 (10)							
Minimum Embedment	$h_{ef,min}$	in. (mm)	2 3/8 (60)	2 3/4 (70)	3 1/8 (79)	3 1/2 (89)	3 1/2 (89)	4 (102)	4 1/2 (114)	5 (127)
Maximum Embedment	$h_{ef,max}$	in. (mm)	7 1/2 (191)	10 (254)	12 1/2 (318)	15 (381)	17 1/2 (445)	20 (508)	22 1/2 (572)	25 (635)
Min. anchor spacing <sup>3</sup>	$s_{min}$	in. (mm)	1 7/8 (48)	2 1/2 (64)	3 1/8 (79)	3 3/4 (95)	4 3/8 (111)	5 (127)	5 5/8 (143)	6 1/4 (159)
Min. edge distance (Threaded rods)	$c_{min}$	in. (mm)	1 3/4 (45)	1 3/4 (45)	2 <sup>(3)</sup> (50) <sup>(3)</sup>	2 1/8 <sup>(3)</sup> (55) <sup>(3)</sup>	2 1/4 <sup>(3)</sup> (60) <sup>(3)</sup>	2 3/4 <sup>(3)</sup> (70) <sup>(3)</sup>	n/a	3 1/8 <sup>(3)</sup> (80) <sup>(3)</sup>
Min. edge distance (Reinforcing bars) <sup>3</sup>	$c_{min}$	-	5d; or see Section 4.1.9.2 of this report for design with reduced minimum edge distances							
Minimum concrete thickness	$h_{min}$	in. (mm)	$h_{ef} + 1 1/4$ ( $h_{ef} + 30$ )		$h_{ef} + 2d_o^{(4)}$					
Critical edge distance – splitting (for uncracked concrete)	$c_{ac}$	-	See Section 4.1.10.2 of this report.							
Strength reduction factor for tension, concrete failure modes, Condition B (supplemental reinforcement not present) <sup>2</sup>	$\phi$	-	0.65							
Strength reduction factor for shear, concrete failure modes, Condition B (supplemental reinforcement not present) <sup>2</sup>	$\phi$	-	0.70							

For SI: 1 inch ≡ 25.4 mm, 1 lbf = 4.448 N, 1 psi = 0.006897 MPa.  
 For pound-inch units: 1 mm = 0.03937 inches, 1 N = 0.2248 lbf, 1 MPa = 145.0 psi

<sup>1</sup> Additional setting information is described in Figure 6, Manufacturers Printed Installation Instructions (MPII).  
<sup>2</sup> The strength reduction factor applies when the load combinations from the IBC or ACI 318 are used and the requirements of ACI 318-19 17.5.3, ACI 318-14 17.3.3 or ACI 318-11 D.4.3, as applicable, are met. If the load combinations of ACI 318-11 Appendix C are used, the appropriate strength reduction factor must be determined in accordance with ACI 318-11 D.4.4.  
<sup>3</sup> For installations with 1 3/4-inch edge distance, refer to Section 4.1.9.2 for spacing and maximum torque requirements.  
<sup>4</sup>  $d_o$  = hole diameter.

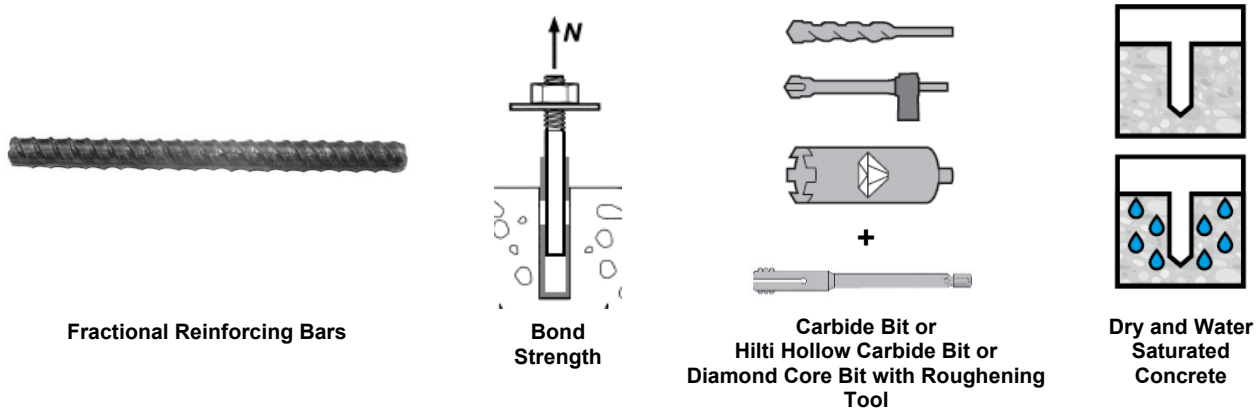

**TABLE 13—BOND STRENGTH DESIGN INFORMATION FOR FRACTIONAL REINFORCING BARS IN HOLES DRILLED WITH A HAMMER DRILL AND CARBIDE BIT (OR HILTI HOLLOW CARBIDE DRILL BIT) OR CORE DRILLED WITH A DIAMOND CORE BIT AND ROUGHENED WITH A HILTI ROUGHENING TOOL<sup>1</sup>**

DESIGN INFORMATION		Symbol	Units	Nominal reinforcing bar size							
				#3	#4	#5	#6	#7	#8	#9	#10
Minimum Embedment		$h_{ef,min}$	in. (mm)	2 <sup>3</sup> / <sub>8</sub> (60)	2 <sup>3</sup> / <sub>4</sub> (70)	3 <sup>1</sup> / <sub>8</sub> (79)	3 <sup>1</sup> / <sub>2</sub> (89)	3 <sup>1</sup> / <sub>2</sub> (89)	4 (102)	4 <sup>1</sup> / <sub>2</sub> (114)	5 (127)
Maximum Embedment		$h_{ef,max}$	in. (mm)	7 <sup>1</sup> / <sub>2</sub> (191)	10 (254)	12 <sup>1</sup> / <sub>2</sub> (318)	15 (381)	17 <sup>1</sup> / <sub>2</sub> (445)	20 (508)	22 <sup>1</sup> / <sub>2</sub> (572)	25 (635)
Temperature range A <sup>2</sup>	Characteristic bond strength in cracked concrete	$\tau_{k,cr}$	psi (MPa)	1,080 (7.4)	1,080 (7.4)	1,090 (7.5)	1,090 (7.5)	835 (5.7)	840 (5.8)	850 (5.9)	850 (5.9)
	Characteristic bond strength in uncracked concrete	$\tau_{k,uncr}$	psi (MPa)	1,560 (10.8)	1,560 (10.8)	1,560 (10.8)	1,560 (10.8)	1,560 (10.8)	1,560 (10.8)	1,560 (10.8)	1,560 (10.8)
Temperature range B <sup>2</sup>	Characteristic bond strength in cracked concrete	$\tau_{k,cr}$	psi (MPa)	1,080 (7.4)	1,080 (7.4)	1,090 (7.5)	1,090 (7.5)	835 (5.7)	840 (5.8)	850 (5.9)	850 (5.9)
	Characteristic bond strength in uncracked concrete	$\tau_{k,uncr}$	psi (MPa)	1,560 (10.8)	1,560 (10.8)	1,560 (10.8)	1,560 (10.8)	1,560 (10.8)	1,560 (10.8)	1,560 (10.8)	1,560 (10.8)
Temperature range C <sup>2</sup>	Characteristic bond strength in cracked concrete	$\tau_{k,cr}$	psi (MPa)	885 (6.1)	890 (6.1)	895 (6.2)	895 (6.2)	685 (4.7)	690 (4.8)	700 (4.8)	700 (4.8)
	Characteristic bond strength in uncracked concrete	$\tau_{k,uncr}$	psi (MPa)	1,280 (8.8)	1,280 (8.8)	1,280 (8.8)	1,280 (8.8)	1,280 (8.8)	1,280 (8.8)	1,280 (8.8)	1,280 (8.8)
Permissible installation conditions	Dry concrete and water saturated concrete 	Anchor Category	-	1							
		$\phi_t, \phi_{ws}$	-	0.65							
Reduction for seismic tension	Hammer drilled 	$\alpha_{N,seis}$	-	0.80			0.85	0.90	0.95	1.0	
	Core drilled + roughening 	$\alpha_{N,seis}$	-	N/A	0.71	0.77	0.82	0.95	0.79	0.83	

For SI: 1 inch = 25.4 mm, 1 lbf = 4.448 N, 1 psi = 0.006897 MPa.  
 For pound-inch units: 1 mm = 0.03937 inches, 1 N = 0.2248 lbf, 1 MPa = 145.0 psi

<sup>1</sup> Bond strength values correspond to concrete compressive strength  $f'_c = 2,500$  psi (17.2 MPa). For concrete compressive strength,  $f'_c$ , between 2,500 psi (17.2 MPa) and 8,000 psi (55.2 MPa), the tabulated characteristic bond strength may be increased by a factor of  $(f'_c / 2,500)^{0.1}$  [For SI:  $(f'_c / 17.2)^{0.1}$ ]. See Section 4.1.4 of this report for bond strength determination.

<sup>2</sup> Temperature range A: Maximum short term temperature = 130°F (55°C), Maximum long term temperature = 110°F (43°C).  
 Temperature range B: Maximum short term temperature = 176°F (80°C), Maximum long term temperature = 110°F (43°C).  
 Temperature range C: Maximum short term temperature = 248°F (120°C), Maximum long term temperature = 162°F (72°C).  
 Short term elevated concrete temperatures are those that occur over brief intervals, e.g., as a result of diurnal cycling. Long term concrete temperatures are roughly constant over significant periods of time.

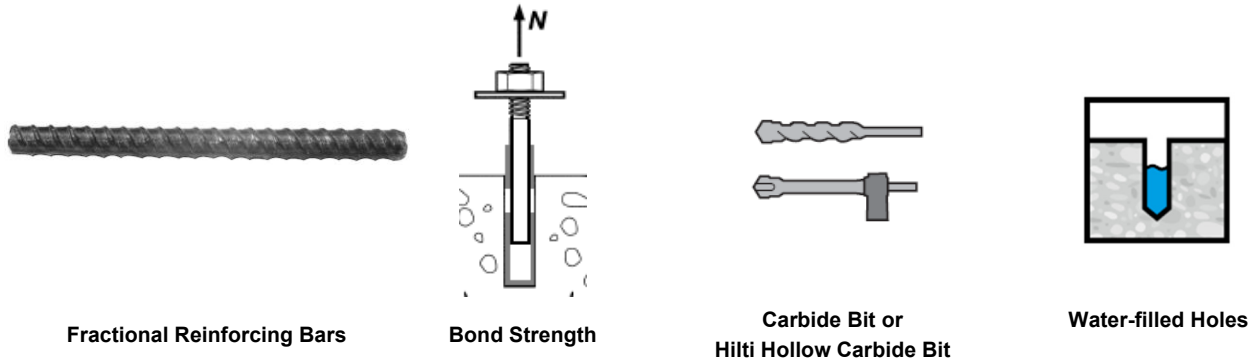

**TABLE 14—BOND STRENGTH DESIGN INFORMATION FOR FRACTIONAL REINFORCING BARS IN HOLES DRILLED WITH A HAMMER DRILL AND CARBIDE BIT (OR HILTI HOLLOW CARBIDE DRILL BIT)**

DESIGN INFORMATION		Symbol	Units	Nominal reinforcing bar size							
				#3	#4	#5	#6	#7	#8	#9	#10
Minimum Embedment		$h_{ef,min}$	in. (mm)	2 <sup>3</sup> / <sub>8</sub> (60)	2 <sup>3</sup> / <sub>4</sub> (70)	3 <sup>1</sup> / <sub>8</sub> (79)	3 <sup>1</sup> / <sub>2</sub> (89)	3 <sup>1</sup> / <sub>2</sub> (89)	4 (102)	4 <sup>1</sup> / <sub>2</sub> (114)	5 (127)
Maximum Embedment		$h_{ef,max}$	in. (mm)	7 <sup>1</sup> / <sub>2</sub> (191)	10 (254)	12 <sup>1</sup> / <sub>2</sub> (318)	15 (381)	17 <sup>1</sup> / <sub>2</sub> (445)	20 (508)	22 <sup>1</sup> / <sub>2</sub> (572)	25 (635)
Temperature range A <sup>2</sup>	Characteristic bond strength in cracked concrete	$\tau_{k,cr}$	psi (MPa)	1,050 (7.2)	1,050 (7.2)	1,070 (7.4)	1,070 (7.4)	820 (5.7)	820 (5.7)	830 (5.7)	830 (5.7)
	Characteristic bond strength in uncracked concrete	$\tau_{k,uncr}$	psi (MPa)	1,520 (10.5)	1,520 (10.5)	1,520 (10.5)	1,520 (10.5)	1,520 (10.5)	1,520 (10.5)	1,520 (10.5)	1,520 (10.5)
Temperature range B <sup>2</sup>	Characteristic bond strength in cracked concrete	$\tau_{k,cr}$	psi (MPa)	1,050 (7.2)	1,050 (7.2)	1,070 (7.4)	1,070 (7.4)	820 (5.7)	820 (5.7)	830 (5.7)	830 (5.7)
	Characteristic bond strength in uncracked concrete	$\tau_{k,uncr}$	psi (MPa)	1,520 (10.5)	1,520 (10.5)	1,520 (10.5)	1,520 (10.5)	1,520 (10.5)	1,520 (10.5)	1,520 (10.5)	1,520 (10.5)
Temperature range C <sup>2</sup>	Characteristic bond strength in cracked concrete	$\tau_{k,cr}$	psi (MPa)	865 (6.0)	865 (6.0)	875 (6.1)	875 (6.1)	670 (4.6)	680 (4.7)	680 (4.7)	680 (4.7)
	Characteristic bond strength in uncracked concrete	$\tau_{k,uncr}$	psi (MPa)	1,250 (8.6)	1,250 (8.6)	1,250 (8.6)	1,250 (8.6)	1,250 (8.6)	1,250 (8.6)	1,250 (8.6)	1,250 (8.6)
Permissible installation conditions	Water-filled Holes 	Anchor Category	-	3							
		$\phi_M$	-	0.45							
Reduction for seismic tension	Hammer drilled 	$\alpha_{N,seis}$	-	0.80			0.85	0.90	0.95	1.0	

For SI: 1 inch ≡ 25.4 mm, 1 lbf = 4.448 N, 1 psi = 0.006897 MPa.  
 For pound-inch units: 1 mm = 0.03937 inches, 1 N = 0.2248 lbf, 1 MPa = 145.0 psi

<sup>1</sup> Bond strength values correspond to concrete compressive strength  $f_c = 2,500$  psi (17.2 MPa). For concrete compressive strength,  $f_c$ , between 2,500 psi (17.2 MPa) and 8,000 psi (55.2 MPa), the tabulated characteristic bond strength may be increased by a factor of  $(f_c / 2,500)^{0.1}$  [For SI:  $(f_c / 17.2)^{0.1}$ ]. See Section 4.1.4 of this report for bond strength determination.

<sup>2</sup> Temperature range A: Maximum short term temperature = 130°F (55°C), Maximum long term temperature = 110°F (43°C).  
 Temperature range B: Maximum short term temperature = 176°F (80°C), Maximum long term temperature = 110°F (43°C).  
 Temperature range C: Maximum short term temperature = 248°F (120°C), Maximum long term temperature = 162°F (72°C).  
 Short term elevated concrete temperatures are those that occur over brief intervals, e.g., as a result of diurnal cycling. Long term concrete temperatures are roughly constant over significant periods of time.

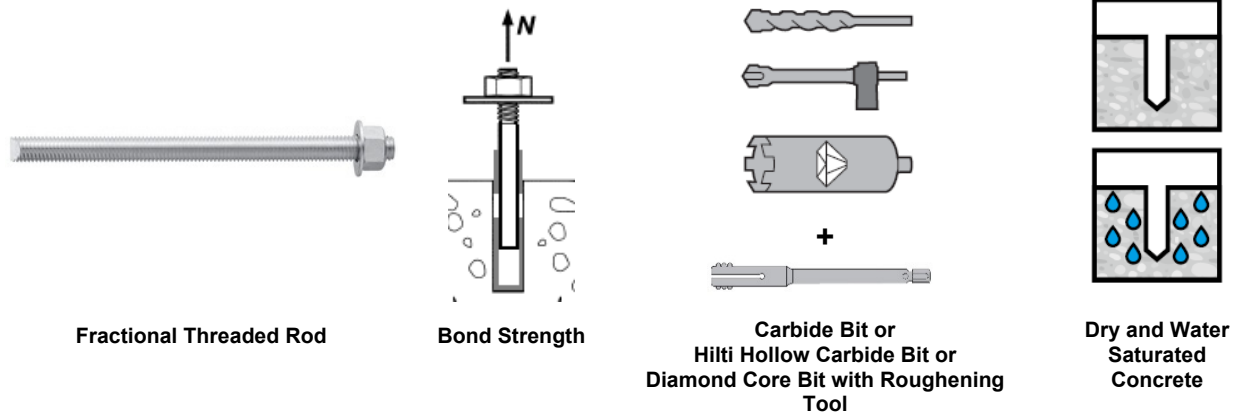

**TABLE 15—BOND STRENGTH DESIGN INFORMATION FOR FRACTIONAL THREADED ROD IN HOLES DRILLED WITH A HAMMER DRILL AND CARBIDE BIT (OR HILTI HOLLOW CARBIDE DRILL BIT) OR CORE DRILLED WITH A DIAMOND CORE BIT AND ROUGHENED WITH A HILTI ROUGHENING TOOL<sup>1</sup>**

DESIGN INFORMATION		Symbol	Units	Nominal rod diameter (in.)						
				3/8	1/2	5/8	3/4	7/8	1	1 1/4
Minimum Embedment		$h_{ef,min}$	in. (mm)	2 3/8 (60)	2 3/4 (70)	3 1/8 (79)	3 1/2 (89)	3 1/2 (89)	4 (102)	5 (127)
Maximum Embedment		$h_{ef,max}$	in. (mm)	7 1/2 (191)	10 (254)	12 1/2 (318)	15 (381)	17 1/2 (445)	20 (508)	25 (635)
Temperature range A <sup>2</sup>	Characteristic bond strength in cracked concrete	$\tau_{k,cr}$	psi (MPa)	1,045 (7.2)	1,135 (7.8)	1,170 (8.1)	1,260 (8.7)	1,290 (8.9)	1,325 (9.1)	1,380 (9.5)
	Characteristic bond strength in uncracked concrete	$\tau_{k,uncr}$	psi (MPa)	2,220 (15.3)	2,220 (15.3)	2,220 (15.3)	2,220 (15.3)	2,220 (15.3)	2,220 (15.3)	2,220 (15.3)
Temperature range B <sup>2</sup>	Characteristic bond strength in cracked concrete	$\tau_{k,cr}$	psi (MPa)	1,045 (7.2)	1,135 (7.8)	1,170 (8.1)	1,260 (8.7)	1,290 (8.9)	1,325 (9.1)	1,380 (9.5)
	Characteristic bond strength in uncracked concrete	$\tau_{k,uncr}$	psi (MPa)	2,220 (15.3)	2,220 (15.3)	2,220 (15.3)	2,220 (15.3)	2,220 (15.3)	2,220 (15.3)	2,220 (15.3)
Temperature range C <sup>2</sup>	Characteristic bond strength in cracked concrete	$\tau_{k,cr}$	psi (MPa)	855 (5.9)	930 (6.4)	960 (6.6)	1,035 (7.1)	1,055 (7.3)	1,085 (7.5)	1,130 (7.8)
	Characteristic bond strength in uncracked concrete	$\tau_{k,uncr}$	psi (MPa)	1,820 (12.6)	1,820 (12.6)	1,820 (12.6)	1,820 (12.6)	1,820 (12.6)	1,820 (12.6)	1,820 (12.6)
Permissible installation conditions	Dry and water saturated concrete	Anchor Category	-	1						
		$\phi_{ds}, \phi_{ws}$	-	0.65						
Reduction for seismic tension	 Hammer drilled	$\alpha_{N,seis}$	-	0.88	0.99	0.99	1.0	1.0	0.95	0.99
	 Core drilled + roughening	$\alpha_{N,seis}$	-	N/A		0.88	0.96	0.96	1.0	0.82

For SI: 1 inch  $\equiv$  25.4 mm, 1 lbf = 4.448 N, 1 psi = 0.006897 MPa.  
For pound-inch units: 1 mm = 0.03937 inches, 1 N = 0.2248 lbf, 1 MPa = 145.0 psi

<sup>1</sup> Bond strength values correspond to concrete compressive strength  $f'_c = 2,500$  psi (17.2 MPa). For concrete compressive strength,  $f'_c$ , between 2,500 psi (17.2 MPa) and 8,000 psi (55.2 MPa), the tabulated characteristic bond strength may be increased by a factor of  $(f'_c / 2,500)^{0.1}$  [For SI:  $(f'_c / 17.2)^{0.1}$ ]. See Section 4.1.4 of this report for bond strength determination.

<sup>2</sup> Temperature range A: Maximum short term temperature = 130°F (55°C), Maximum long term temperature = 110°F (43°C).

Temperature range B: Maximum short term temperature = 176°F (80°C), Maximum long term temperature = 110°F (43°C).

Temperature range C: Maximum short term temperature = 248°F (120°C), Maximum long term temperature = 162°F (72°C).

Short term elevated concrete temperatures are those that occur over brief intervals, e.g., as a result of diurnal cycling. Long term concrete temperatures are roughly constant over significant periods of time.

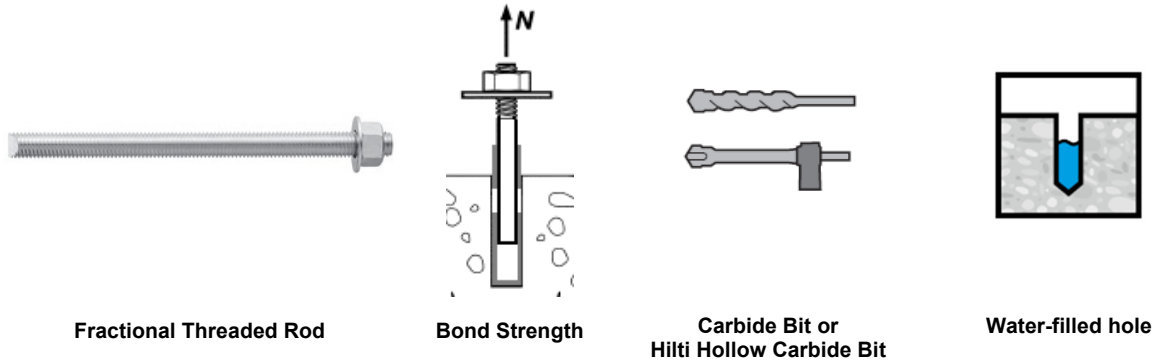

**TABLE 16—BOND STRENGTH DESIGN INFORMATION FOR FRACTIONAL THREADED ROD IN HOLES DRILLED WITH A HAMMER DRILL AND CARBIDE BIT (OR HILTI HOLLOW CARBIDE DRILL BIT)**

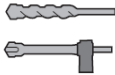
DESIGN INFORMATION		Symbol	Units	Nominal rod diameter (in.)						
				3/8	1/2	5/8	3/4	7/8	1	1 1/4
Minimum Embedment		$h_{ef,min}$	in. (mm)	2 3/8 (60)	2 3/4 (70)	3 1/8 (79)	3 1/2 (89)	3 1/2 (89)	4 (102)	5 (127)
Maximum Embedment		$h_{ef,max}$	in. (mm)	7 1/2 (191)	10 (254)	12 1/2 (318)	15 (381)	17 1/2 (445)	20 (508)	25 (635)
Temperature range A <sup>2</sup>	Characteristic bond strength in cracked concrete	$\tau_{k,cr}$	psi (MPa)	825 (5.7)	875 (6.0)	865 (6.0)	910 (6.3)	890 (6.1)	885 (6.1)	840 (5.8)
	Characteristic bond strength in uncracked concrete	$\tau_{k,uncr}$	psi (MPa)	1,755 (12.1)	1,710 (11.8)	1,645 (11.3)	1,600 (11)	1,535 (10.6)	1,490 (10.3)	1,355 (9.3)
Temperature range B <sup>2</sup>	Characteristic bond strength in cracked concrete	$\tau_{k,cr}$	psi (MPa)	825 (5.7)	875 (6.0)	865 (6.0)	910 (6.3)	890 (6.1)	885 (6.1)	840 (5.8)
	Characteristic bond strength in uncracked concrete	$\tau_{k,uncr}$	psi (MPa)	1,755 (12.1)	1,710 (11.8)	1,645 (11.3)	1,600 (11.0)	1,535 (10.6)	1,490 (10.3)	1,355 (9.3)
Temperature range C <sup>2</sup>	Characteristic bond strength in cracked concrete	$\tau_{k,cr}$	psi (MPa)	675 (4.7)	715 (4.9)	710 (4.9)	745 (5.1)	730 (5.0)	730 (5.0)	690 (4.8)
	Characteristic bond strength in uncracked concrete	$\tau_{k,uncr}$	psi (MPa)	1,440 (9.9)	1,405 (9.7)	1,350 (9.3)	1,310 (9.0)	1,260 (8.7)	1,220 (8.4)	1,110 (7.7)
Permissible installation conditions		Anchor Category	-	3						
		$\phi_{wf}$	-	0.45						
Reduction for seismic tension	 Hammer drilled	$\alpha_{N,seis}$	-	0.88	0.99	0.99	1.0	1.0	0.95	0.99

For SI: 1 inch ≅ 25.4 mm, 1 lbf = 4.448 N, 1 psi = 0.006897 MPa.

For pound-inch units: 1 mm = 0.03937 inches, 1 N = 0.2248 lbf, 1 MPa = 145.0 psi

<sup>1</sup> Bond strength values correspond to concrete compressive strength  $f'_c = 2,500$  psi (17.2 MPa). For concrete compressive strength,  $f'_c$ , between 2,500 psi (17.2 MPa) and 8,000 psi (55.2 MPa), the tabulated characteristic bond strength may be increased by a factor of  $(f'_c / 2,500)^{0.1}$  [For SI:  $(f'_c / 17.2)^{0.1}$ ]. See Section 4.1.4 of this report for bond strength determination.

<sup>2</sup> Temperature range A: Maximum short-term temperature = 130°F (55°C), Maximum long-term temperature = 110°F (43°C).

Temperature range B: Maximum short-term temperature = 176°F (80°C), Maximum long-term temperature = 110°F (43°C).

Temperature range C: Maximum short-term temperature = 248°F (120°C), Maximum long-term temperature = 162°F (72°C).

short-term elevated concrete temperatures are those that occur over brief intervals, e.g., as a result of diurnal cycling. long-term concrete temperatures are roughly constant over significant periods of time.



TABLE 17—STEEL DESIGN INFORMATION FOR METRIC THREADED ROD AND EU METRIC REINFORCING BARS

DESIGN INFORMATION			Symbol	Units	Nominal rod diameter (mm) <sup>1</sup>							
					10	12	16	20	24	27	30	
Rod Outside Diameter			<i>d</i>	mm (in.)	10 (0.39)	12 (0.47)	16 (0.63)	20 (0.79)	24 (0.94)	27 (1.06)	30 (1.18)	
Rod effective cross-sectional area			<i>A<sub>se</sub></i>	mm <sup>2</sup> (in. <sup>2</sup> )	58.0 (0.090)	84.3 (0.131)	157 (0.243)	245 (0.380)	353 (0.547)	459 (0.711)	561 (0.870)	
ISO 898-1 Class 5.8	Nominal strength as governed by steel strength		<i>N<sub>sa</sub></i>	kN (lb)	29.0 (6,519)	42.0 (9,476)	78.5 (17,647)	122.5 (27,539)	176.5 (39,679)	229.5 (51,594)	280.5 (63,059)	
			<i>V<sub>sa</sub></i>	kN (lb)	14.5 (3,260)	25.5 (5,685)	47.0 (10,588)	73.5 (16,523)	106.0 (23,807)	137.5 (30,956)	168.5 (37,835)	
	Reduction for seismic shear		<i>α<sub>V,seis</sub></i>	-	1.00							
	Strength reduction factor for tension <sup>2</sup>		<i>φ</i>	-	0.65							
	Strength reduction factor for shear <sup>2</sup>		<i>φ</i>	-	0.60							
ISO 898-1 Class 8.8	Nominal strength as governed by steel strength		<i>N<sub>sa</sub></i>	kN (lb)	46.5 (10,431)	67.5 (15,161)	125.5 (28,236)	196.0 (44,063)	282.5 (63,486)	367.0 (82,550)	449.0 (100,894)	
			<i>V<sub>sa</sub></i>	kN (lb)	23.0 (5,216)	40.5 (9,097)	75.5 (16,942)	117.5 (26,438)	169.5 (38,092)	220.5 (49,530)	269.5 (60,537)	
	Reduction for seismic shear		<i>α<sub>V,seis</sub></i>	-	1.00							
	Strength reduction factor for tension <sup>2</sup>		<i>φ</i>	-	0.65							
	Strength reduction factor for shear <sup>2</sup>		<i>φ</i>	-	0.60							
ISO 3506-1 Class A4 Stainless <sup>3</sup>	Nominal strength as governed by steel strength		<i>N<sub>sa</sub></i>	kN (lb)	40.6 (9,127)	59.0 (13,266)	109.9 (24,706)	171.5 (38,555)	247.1 (55,550)	183.1 (41,172)	223.8 (50,321)	
			<i>V<sub>sa</sub></i>	kN (lb)	20.3 (4,564)	35.4 (7,960)	65.9 (14,824)	102.9 (23,133)	148.3 (33,330)	109.9 (24,703)	134.3 (30,192)	
	Reduction for seismic shear		<i>α<sub>V,seis</sub></i>	-	0.80							
	Strength reduction factor for tension <sup>2</sup>		<i>φ</i>	-	0.65							
	Strength reduction factor for shear <sup>2</sup>		<i>φ</i>	-	0.60							
DESIGN INFORMATION			Symbol	Units	Reinforcing bar size							
Nominal bar diameter			<i>d</i>	mm (in.)	10.0 (0.394)	12.0 (0.472)	14.0 (0.551)	16.0 (0.630)	20.0 (0.787)	25.0 (0.984)	28.0 (1.102)	32.0 (1.260)
Bar effective cross-sectional area			<i>A<sub>se</sub></i>	mm <sup>2</sup> (in. <sup>2</sup> )	78.5 (0.122)	113.1 (0.175)	153.9 (0.239)	201.1 (0.312)	314.2 (0.487)	490.9 (0.761)	615.8 (0.954)	804.2 (1.247)
DIN 488 BSt 550/500	Nominal strength as governed by steel strength		<i>N<sub>sa</sub></i>	kN (lb)	43.0 (9,711)	62.0 (13,984)	84.5 (19,034)	110.5 (24,860)	173.0 (38,844)	270.0 (60,694)	338.5 (76,135)	442.5 (99,441)
			<i>V<sub>sa</sub></i>	kN (lb)	26.0 (5,827)	37.5 (8,390)	51.0 (11,420)	66.5 (14,916)	103.0 (23,307)	162.0 (36,416)	203.0 (45,681)	265.5 (59,665)
	Reduction for seismic shear		<i>α<sub>V,seis</sub></i>	-	0.70							
	Strength reduction factor for tension <sup>2</sup>		<i>φ</i>	-	0.65							
	Strength reduction factor for shear <sup>2</sup>		<i>φ</i>	-	0.60							

For SI: 1 inch ≅ 25.4 mm, 1 lbf = 4.448 N, 1 psi = 0.006897 MPa.  
 For pound-inch units: 1 mm = 0.03937 inches, 1 N = 0.2248 lbf, 1 MPa = 145.0 psi

<sup>1</sup> Values provided for common rod material types are based on specified strengths and calculated in accordance with ACI 318-19 Eq. (17.6.1.2) and Eq (17.7.1.2b), ACI 318-14 Eq. (17.4.1.2) and Eq (17.5.1.2b) or ACI 318-11 Eq. (D-2) and Eq. (D-29). Nuts and washers must be appropriate for the rod.  
<sup>2</sup> The strength reduction factor applies when the load combinations from the IBC or ACI 318 are used and the requirements of ACI 318-19 17.5.3, ACI 318-14 17.3.3 or ACI 318-11 D.4.3, as applicable, are met. If the load combinations of ACI 318-11 Appendix C are used, the appropriate strength reduction factor must be determined in accordance with ACI 318-11 D.4.4.  
<sup>3</sup> A4-70 Stainless (M8- M24); A4-502 Stainless (M27- M30)



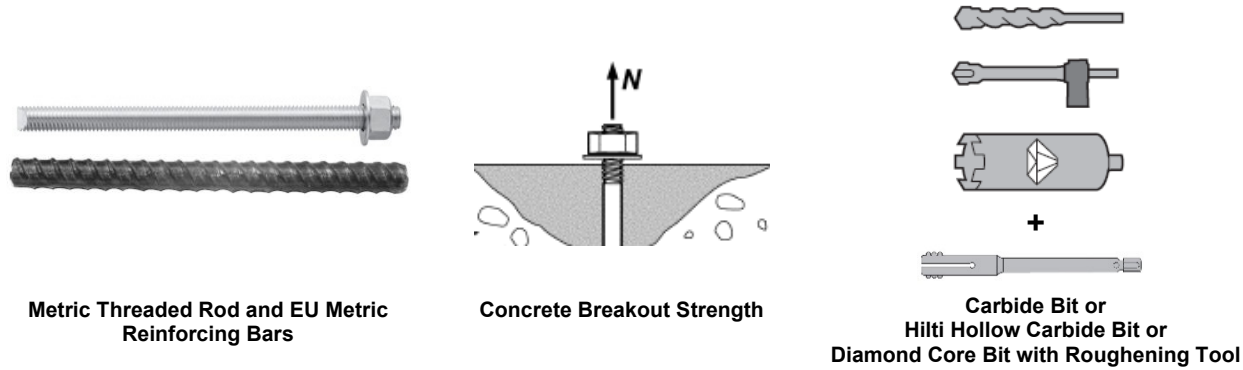
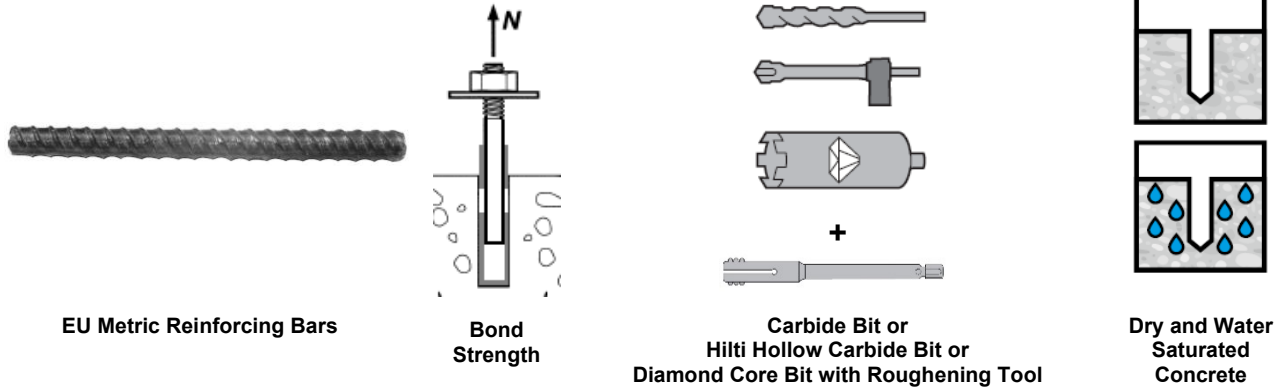

**TABLE 18—CONCRETE BREAKOUT DESIGN INFORMATION FOR METRIC THREADED ROD AND EU METRIC REINFORCING BARS IN HOLES DRILLED WITH A HAMMER DRILL AND CARBIDE BIT (OR HILTI HOLLOW CARBIDE DRILL BIT) OR CORE DRILLED WITH A DIAMOND CORE BIT AND ROUGHENED WITH A HILTI ROUGHENING TOOL<sup>1</sup>**

DESIGN INFORMATION	Symbol	Units	Nominal rod diameter (mm)							
			10	12	16	20	24	27	30	
Minimum Embedment	$h_{ef,min}$	mm (in.)	60 (2.4)	70 (2.8)	80 (3.1)	90 (3.5)	96 (3.8)	108 (4.3)	120 (4.7)	
Maximum Embedment	$h_{ef,max}$	mm (in.)	200 (7.9)	240 (9.4)	320 (12.6)	400 (15.7)	480 (18.9)	540 (21.3)	600 (23.6)	
Min. anchor spacing <sup>3</sup>	$s_{min}$	mm (in.)	50 (2.0)	60 (2.4)	80 (3.2)	100 (3.9)	120 (4.7)	135 (5.3)	150 (5.9)	
Min. edge distance <sup>3</sup>	$c_{min}$	-	5d; or see Section 4.1.9.2 of this report for design with reduced minimum edge distances							
Minimum concrete thickness	$h_{min}$	mm (in.)	$h_{ef} + 30$ $(h_{ef} + 1\frac{1}{4})$	$h_{ef} + 2d_o^{(4)}$						
DESIGN INFORMATION	Symbol	Units	Reinforcing bar size							
			10	12	14	16	20	25	28	32
Minimum Embedment	$h_{ef,min}$	mm (in.)	60 (2.4)	70 (2.8)	75 (3.0)	80 (3.1)	90 (3.5)	100 (3.9)	112 (4.4)	128 (5.0)
Maximum Embedment	$h_{ef,max}$	mm (in.)	200 (7.9)	240 (9.4)	280 (11.0)	320 (12.6)	400 (15.7)	500 (19.7)	560 (22.0)	640 (25.2)
Min. anchor spacing <sup>3</sup>	$s_{min}$	mm (in.)	50 (2.0)	60 (2.4)	80 (3.2)	100 (3.9)	120 (4.7)	135 (5.3)	140 (5.5)	160 (6.3)
Min. edge distance <sup>3</sup>	$c_{min}$	-	5d; or see Section 4.1.9 of this report for design with reduced minimum edge distances							
Minimum concrete thickness	$h_{min}$	mm (in.)	$h_{ef} + 30$ $(h_{ef} + 1\frac{1}{4})$	$h_{ef} + 2d_o^{(4)}$						
Critical edge distance – splitting (for uncracked concrete)	$c_{ac}$	-	See Section 4.1.10.2 of this report.							
Effectiveness factor for cracked concrete	$k_{c,cr}$	SI (in-lb)	7.1 (17)							
Effectiveness factor for uncracked concrete	$k_{c,uncr}$	SI (in-lb)	10 (24)							
Strength reduction factor for tension, concrete failure modes, Condition B (supplemental reinforcement not present) <sup>2</sup>	$\phi$	-	0.65							
Strength reduction factor for shear, concrete failure modes, Condition B (supplemental reinforcement not present) <sup>2</sup>	$\phi$	-	0.70							

For SI: 1 inch  $\equiv$  25.4 mm, 1 lbf = 4.448 N, 1 psi = 0.006897 MPa.  
For pound-inch units: 1 mm = 0.03937 inches, 1 N = 0.2248 lbf, 1 MPa = 145.0 psi

<sup>1</sup> Additional setting information is described in Figure 6, Manufacturers Printed Installation Instructions (MPII).  
<sup>2</sup> The strength reduction factor applies when the load combinations from the IBC or ACI 318 are used and the requirements of ACI 318-19 17.5.3, ACI 318-14 17.3.3 or ACI 318-11 D.4.3, as applicable, are met. If the load combinations of ACI 318-11 Appendix C are used, the appropriate strength reduction factor must be determined in accordance with ACI 318-11 D.4.4.  
<sup>3</sup> For installations with 1<sup>3</sup>/<sub>4</sub>-inch edge distance, refer to Section 4.1.9.2 for spacing and maximum torque requirements.  
<sup>4</sup>  $d_o$  = hole diameter.



**TABLE 19—BOND STRENGTH DESIGN INFORMATION FOR EU METRIC REINFORCING BARS**

**IN HOLES DRILLED WITH A HAMMER DRILL AND CARBIDE BIT (OR HILTI HOLLOW CARBIDE DRILL BIT) OR CORE DRILLED WITH A DIAMOND CORE BIT AND ROUGHENED WITH A HILTI ROUGHENING TOOL<sup>1</sup>**

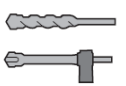
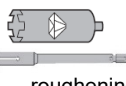
DESIGN INFORMATION		Symbol	Units	Reinforcing bar size							
				10	12	14	16	20	25	28	32
Minimum Embedment		$h_{ef,min}$	mm (in.)	60 (2.4)	70 (2.8)	75 (3.0)	80 (3.1)	90 (3.5)	100 (3.9)	112 (4.4)	128 (5.0)
Maximum Embedment		$h_{ef,max}$	mm (in.)	200 (7.9)	240 (9.4)	280 (11.0)	320 (12.6)	400 (15.7)	500 (19.7)	560 (22.0)	640 (25.2)
Temperature range A <sup>2</sup>	Characteristic bond strength in cracked concrete	$\tau_{k,cr}$	MPa (psi)	7.4 (1,075)	7.5 (1,080)	7.5 (1,085)	7.5 (1,090)	7.5 (1,095)	5.8 (840)	5.8 (845)	5.9 (850)
	Characteristic bond strength in uncracked concrete	$\tau_{k,uncr}$	MPa (psi)	10.8 (1,560)	10.8 (1,560)	10.8 (1,560)	10.8 (1,560)	10.8 (1,560)	10.8 (1,560)	10.8 (1,560)	10.8 (1,560)
Temperature range B <sup>2</sup>	Characteristic bond strength in cracked concrete	$\tau_{k,cr}$	MPa (psi)	7.4 (1,075)	7.5 (1,080)	7.5 (1,085)	7.5 (1,090)	7.5 (1,095)	5.8 (840)	5.8 (845)	5.9 (850)
	Characteristic bond strength in uncracked concrete	$\tau_{k,uncr}$	MPa (psi)	10.8 (1,560)	10.8 (1,560)	10.8 (1,560)	10.8 (1,560)	10.8 (1,560)	10.8 (1,560)	10.8 (1,560)	10.8 (1,560)
Temperature range C <sup>2</sup>	Characteristic bond strength in cracked concrete	$\tau_{k,cr}$	MPa (psi)	6.1 (885)	6.1 (885)	6.1 (890)	6.2 (895)	6.2 (900)	4.8 (690)	4.8 (695)	4.8 (700)
	Characteristic bond strength in uncracked concrete	$\tau_{k,uncr}$	MPa (psi)	8.8 (1,280)	8.8 (1,280)	8.8 (1,280)	8.8 (1,280)	8.8 (1,280)	8.8 (1,280)	8.8 (1,280)	8.8 (1,280)
Permissible Installation Conditions	Dry and water saturated concrete	Anchor Category	-	1							
		$\phi_d, \phi_{ws}$	-	0.65							
Reduction for seismic tension	 Hammer drilled	$\alpha_{N,seis}$	-	0.80				0.85	0.90	1.00	
	 Core drilled + roughening	$\alpha_{N,seis}$	-	N/A			0.71	0.77	0.86	0.78	0.86

For SI: 1 inch ≡ 25.4 mm, 1 lbf = 4.448 N, 1 psi = 0.006897 MPa.  
For pound-inch units: 1 mm = 0.03937 inches, 1 N = 0.2248 lbf, 1 MPa = 145.0 psi

<sup>1</sup> Bond strength values correspond to concrete compressive strength  $f'_c = 2,500$  psi (17.2 MPa). For concrete compressive strength,  $f'_c$ , between 2,500 psi (17.2 MPa) and 8,000 psi (55.2 MPa), the tabulated characteristic bond strength may be increased by a factor of  $(f'_c / 2,500)^{0.1}$  [For SI:  $(f'_c / 17.2)^{0.1}$ ]. See Section 4.1.4 of this report for bond strength determination.

<sup>2</sup> Temperature range A: Maximum short term temperature = 130°F (55°C), Maximum long term temperature = 110°F (43°C).  
Temperature range B: Maximum short term temperature = 176°F (80°C), Maximum long term temperature = 110°F (43°C).  
Temperature range C: Maximum short term temperature = 248°F (120°C), Maximum long term temperature = 162°F (72°C).  
Short term elevated concrete temperatures are those that occur over brief intervals, e.g., as a result of diurnal cycling. Long term concrete temperatures are roughly constant over significant periods of time.

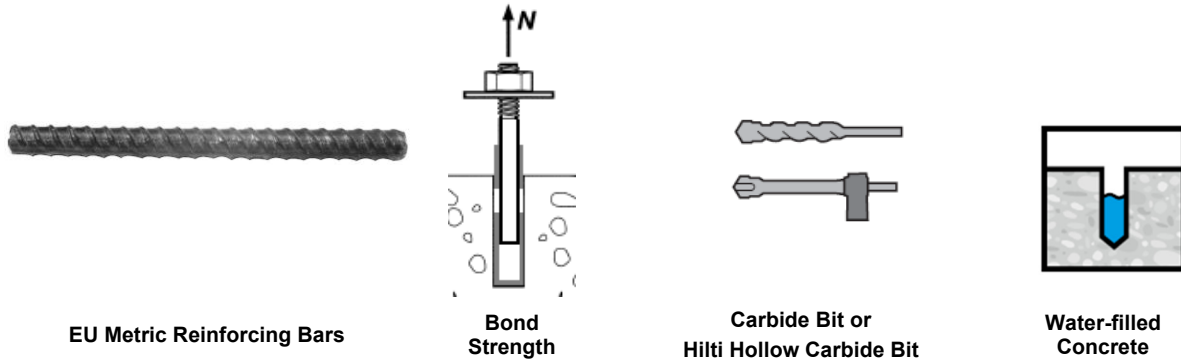

**TABLE 20—BOND STRENGTH DESIGN INFORMATION FOR FRACTIONAL REINFORCING BARS IN HOLES DRILLED WITH A HAMMER DRILL AND CARBIDE BIT (OR HILTI HOLLOW CARBIDE DRILL BIT)**

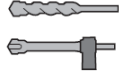
DESIGN INFORMATION		Symbol	Units	Nominal reinforcing bar size							
				10	12	14	16	20	25	28	32
Minimum Embedment		$h_{ef,min}$	in. (mm)	2 <sup>3</sup> / <sub>8</sub> (60)	2 <sup>3</sup> / <sub>4</sub> (70)	3 <sup>1</sup> / <sub>8</sub> (79)	3 <sup>1</sup> / <sub>2</sub> (89)	3 <sup>1</sup> / <sub>2</sub> (89)	4 (102)	4 <sup>1</sup> / <sub>2</sub> (114)	5 (127)
Maximum Embedment		$h_{ef,max}$	in. (mm)	7 <sup>1</sup> / <sub>2</sub> (191)	10 (254)	12 <sup>1</sup> / <sub>2</sub> (318)	15 (381)	17 <sup>1</sup> / <sub>2</sub> (445)	20 (508)	22 <sup>1</sup> / <sub>2</sub> (572)	25 (635)
Temperature range A <sup>2</sup>	Characteristic bond strength in cracked concrete	$\tau_{k,cr}$	MPa (psi)	(7.2) 1,050	(7.2) 1,050	(7.2) 1,050	(7.4) 1,070	(7.4) 1,070	(5.7) 820	(5.7) 820	(5.7) 830
	Characteristic bond strength in uncracked concrete	$\tau_{k,uncr}$	MPa (psi)	(10.5) 1,520	(10.5) 1,520	(10.5) 1,520	(10.5) 1,520	(10.5) 1,520	(10.5) 1,520	(10.5) 1,520	(10.5) 1,520
Temperature range B <sup>2</sup>	Characteristic bond strength in cracked concrete	$\tau_{k,cr}$	MPa (psi)	(7.2) 1,050	(7.2) 1,050	(7.2) 1,050	(7.4) 1,070	(7.4) 1,070	(5.7) 820	(5.7) 820	(5.7) 830
	Characteristic bond strength in uncracked concrete	$\tau_{k,uncr}$	MPa (psi)	(10.5) 1,520	(10.5) 1,520	(10.5) 1,520	(10.5) 1,520	(10.5) 1,520	(10.5) 1,520	(10.5) 1,520	(10.5) 1,520
Temperature range C <sup>2</sup>	Characteristic bond strength in cracked concrete	$\tau_{k,cr}$	MPa (psi)	(6.0) 865	(6.0) 865	(6.0) 865	(6.1) 875	(6.1) 875	(4.7) 680	(4.7) 680	(4.7) 680
	Characteristic bond strength in uncracked concrete	$\tau_{k,uncr}$	MPa (psi)	(8.6) 1,250	(8.6) 1,250	(8.6) 1,250	(8.6) 1,250	(8.6) 1,250	(8.6) 1,250	(8.6) 1,250	(8.6) 1,250
Permissible installation conditions	Water-filled Hole 	Anchor Category	-	3							
		$\phi_{wf}$	-	0.45							
Reduction for seismic tension	Hammer drilled 	$\alpha_{N,seis}$	-	0.80			0.85	0.90	0.95	1.0	

For SI: 1 inch ≅ 25.4 mm, 1 lbf = 4.448 N, 1 psi = 0.006897 MPa.

For pound-inch units: 1 mm = 0.03937 inches, 1 N = 0.2248 lbf, 1 MPa = 145.0 psi

<sup>1</sup> Bond strength values correspond to concrete compressive strength  $f_c = 2,500$  psi (17.2 MPa). For concrete compressive strength,  $f_c$ , between 2,500 psi (17.2 MPa) and 8,000 psi (55.2 MPa), the tabulated characteristic bond strength may be increased by a factor of  $(f_c / 2,500)^{0.1}$  [For SI:  $(f_c / 17.2)^{0.1}$ ]. See Section 4.1.4 of this report for bond strength determination.

<sup>2</sup> Temperature range A: Maximum short term temperature = 130°F (55°C), Maximum long term temperature = 110°F (43°C).  
 Temperature range B: Maximum short term temperature = 176°F (80°C), Maximum long term temperature = 110°F (43°C).  
 Temperature range C: Maximum short term temperature = 248°F (120°C), Maximum long term temperature = 162°F (72°C).

Short term elevated concrete temperatures are those that occur over brief intervals, e.g., as a result of diurnal cycling. Long term concrete temperatures are roughly constant over significant periods of time.

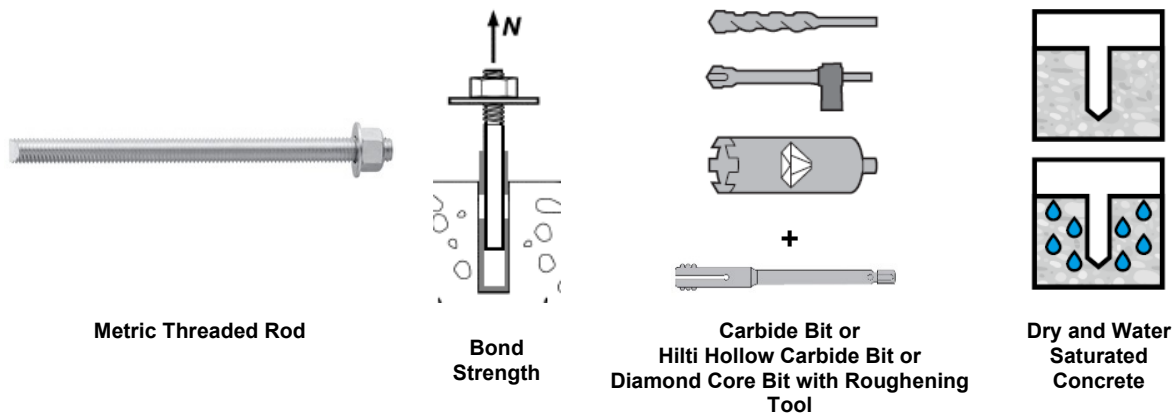

**TABLE 21—BOND STRENGTH DESIGN INFORMATION FOR METRIC THREADED ROD**

**IN HOLES DRILLED WITH A HAMMER DRILL AND CARBIDE BIT (OR HILTI HOLLOW CARBIDE DRILL BIT) OR CORE DRILLED WITH A DIAMOND CORE BIT AND ROUGHENED WITH A HILTI ROUGHENING TOOL<sup>1</sup>**

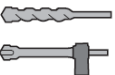
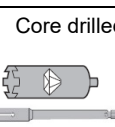
DESIGN INFORMATION		Symbol	Units	Nominal rod diameter (mm)						
				10	12	16	20	24	27	30
Minimum Embedment		$h_{ef,min}$	mm (in.)	60 (2.4)	70 (2.8)	80 (3.1)	90 (3.5)	96 (3.8)	108 (4.3)	120 (4.7)
Maximum Embedment		$h_{ef,max}$	mm (in.)	200 (7.9)	240 (9.4)	320 (12.6)	400 (15.7)	480 (18.9)	540 (21.3)	600 (23.6)
Temperature range A <sup>2</sup>	Characteristic bond strength in cracked concrete	$\tau_{k,cr}$	MPa (psi)	7.3 (1,055)	7.6 (1,105)	8.1 (1,170)	8.8 (1,270)	9.0 (1,305)	9.2 (1,340)	9.4 (1,365)
	Characteristic bond strength in uncracked concrete	$\tau_{k,uncr}$	MPa (psi)	15.3 (2,220)	15.3 (2,220)	15.3 (2,220)	15.3 (2,220)	15.3 (2,220)	15.3 (2,220)	15.3 (2,220)
Temperature range B <sup>2</sup>	Characteristic bond strength in cracked concrete	$\tau_{k,cr}$	MPa (psi)	7.3 (1,055)	7.6 (1,105)	8.1 (1,170)	8.8 (1,270)	9.0 (1,305)	9.2 (1,340)	9.4 (1,365)
	Characteristic bond strength in uncracked concrete	$\tau_{k,uncr}$	MPa (psi)	15.3 (2,220)	15.3 (2,220)	15.3 (2,220)	15.3 (2,220)	15.3 (2,220)	15.3 (2,220)	15.3 (2,220)
Temperature range C <sup>2</sup>	Characteristic bond strength in cracked concrete	$\tau_{k,cr}$	MPa (psi)	6.0 (865)	6.3 (905)	6.6 (960)	7.2 (1,040)	7.4 (1,070)	7.6 (1,095)	7.7 (1,120)
	Characteristic bond strength in uncracked concrete	$\tau_{k,uncr}$	MPa (psi)	12.6 (1,820)	12.6 (1,820)	12.6 (1,820)	12.6 (1,820)	12.6 (1,820)	12.6 (1,820)	12.6 (1,820)
Permissible Installation Conditions	Dry and water saturated concrete	Anchor Category	-	1						
		$\phi_a, \phi_{ws}$	-	0.65						
Reduction for seismic tension	 Hammer drilled	$\alpha_{N,seis}$	-	0.88	0.88	0.99	1.0	0.95	0.95	0.95
	 Core drilled + roughening	$\alpha_{N,seis}$	-	N/A		0.88	0.96	0.96	0.82	0.82

For SI: 1 inch  $\equiv$  25.4 mm, 1 lbf = 4.448 N, 1 psi = 0.006897 MPa.  
For pound-inch units: 1 mm = 0.03937 inches, 1 N = 0.2248 lbf, 1 MPa = 145.0 psi

<sup>1</sup> Bond strength values correspond to concrete compressive strength  $f'_c = 2,500$  psi (17.2 MPa). For concrete compressive strength,  $f'_c$ , between 2,500 psi (17.2 MPa) and 8,000 psi (55.2 MPa), the tabulated characteristic bond strength may be increased by a factor of  $(f'_c / 2,500)^{0.1}$  [For SI:  $(f'_c / 17.2)^{0.1}$ ]. See Section 4.1.4 of this report for bond strength determination.

<sup>2</sup> Temperature range A: Maximum short term temperature = 130°F (55°C), Maximum long term temperature = 110°F (43°C).  
Temperature range B: Maximum short term temperature = 176°F (80°C), Maximum long term temperature = 110°F (43°C).  
Temperature range C: Maximum short term temperature = 248°F (120°C), Maximum long term temperature = 162°F (72°C).  
Short term elevated concrete temperatures are those that occur over brief intervals, e.g., as a result of diurnal cycling. Long term concrete temperatures are roughly constant over significant periods of time.

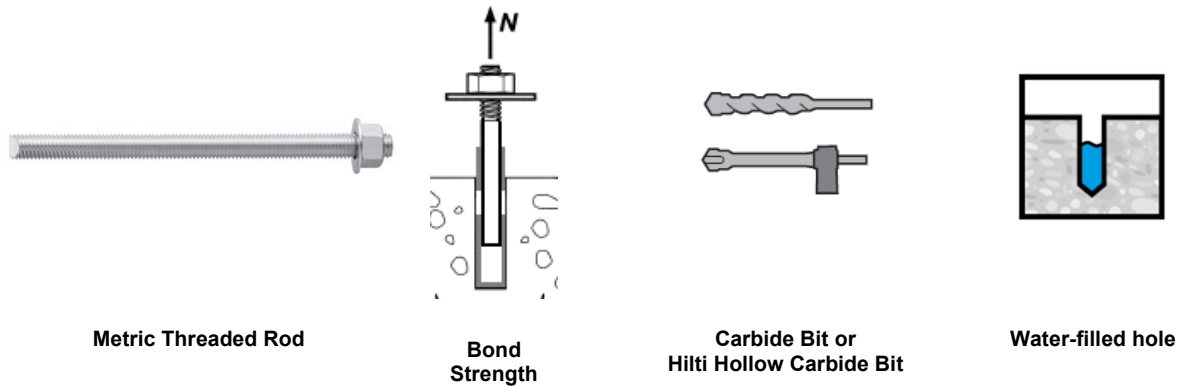

Metric Threaded Rod

Bond Strength

Carbide Bit or Hilti Hollow Carbide Bit

Water-filled hole

TABLE 22—BOND STRENGTH DESIGN INFORMATION FOR METRIC THREADED ROD IN HOLES DRILLED WITH A HAMMER DRILL AND CARBIDE BIT (OR HILTI HOLLOW CARBIDE DRILL BIT)

DESIGN INFORMATION		Symbol	Units	Nominal rod diameter (mm)						
				10	12	16	20	24	27	30
Minimum Embedment		$h_{ef,min}$	mm (in.)	60 (2.4)	70 (2.8)	80 (3.1)	90 (3.5)	96 (3.8)	108 (4.3)	120 (4.7)
Maximum Embedment		$h_{ef,max}$	mm (in.)	200 (7.9)	240 (9.4)	320 (12.6)	400 (15.7)	480 (18.9)	540 (21.3)	600 (23.6)
Temperature range A <sup>2</sup>	Characteristic bond strength in cracked concrete	$\tau_{k,cr}$	MPa (psi)	5.8 (835)	5.9 (850)	6.0 (865)	6.2 (900)	6.1 (885)	6.0 (870)	5.9 (860)
	Characteristic bond strength in uncracked concrete	$\tau_{k,uncr}$	MPa (psi)	12.1 (1755)	11.8 (1710)	11.3 (1645)	10.9 (1580)	10.4 (1510)	10.0 (1445)	9.7 (1400)
Temperature range B <sup>2</sup>	Characteristic bond strength in cracked concrete	$\tau_{k,cr}$	MPa (psi)	5.8 (835)	5.9 (850)	6.0 (865)	6.2 (900)	6.1 (885)	6.0 (870)	5.9 (860)
	Characteristic bond strength in uncracked concrete	$\tau_{k,uncr}$	MPa (psi)	12.1 (1755)	11.8 (1710)	11.3 (1645)	10.9 (1580)	10.4 (1510)	10.0 (1445)	9.7 (1400)
Temperature range C <sup>2</sup>	Characteristic bond strength in cracked concrete	$\tau_{k,cr}$	MPa (psi)	4.7 (685)	4.8 (700)	4.9 (710)	5.1 (740)	5.0 (725)	4.9 (715)	4.9 (705)
	Characteristic bond strength in uncracked concrete	$\tau_{k,uncr}$	MPa (psi)	9.9 (1440)	9.7 (1405)	9.3 (1350)	8.9 (1295)	8.5 (1240)	8.2 (1185)	7.9 (1150)
Permissible Installation Conditions	Water-filled hole 	Anchor Category	-	3						
		$\phi_{wf}$	-	0.45						
Reduction for seismic tension	 Hammer drilled	$\alpha_{N,seis}$	-	0.88	0.88	0.99	1.0	0.95	0.95	0.95

For SI: 1 inch  $\equiv$  25.4 mm, 1 lbf = 4.448 N, 1 psi = 0.006897 MPa.  
 For pound-inch units: 1 mm = 0.03937 inches, 1 N = 0.2248 lbf, 1 MPa = 145.0 psi

<sup>1</sup> Bond strength values correspond to concrete compressive strength  $f'_c = 2,500$  psi (17.2 MPa). For concrete compressive strength,  $f'_c$ , between 2,500 psi (17.2 MPa) and 8,000 psi (55.2 MPa), the tabulated characteristic bond strength may be increased by a factor of  $(f'_c / 2,500)^{0.1}$  [For SI:  $(f'_c / 17.2)^{0.1}$ ]. See Section 4.1.4 of this report for bond strength determination.

<sup>2</sup> Temperature range A: Maximum short-term temperature = 130°F (55°C), Maximum long-term temperature = 110°F (43°C).

Temperature range B: Maximum short-term temperature = 176°F (80°C), Maximum long-term temperature = 110°F (43°C).

Temperature range C: Maximum short-term temperature = 248°F (120°C), Maximum long-term temperature = 162°F (72°C).

short-term elevated concrete temperatures are those that occur over brief intervals, e.g., as a result of diurnal cycling. long-term concrete temperatures are roughly constant over significant periods of time.



Canadian Reinforcing Bars

Steel Strength

TABLE 23—STEEL DESIGN INFORMATION FOR CANADIAN METRIC REINFORCING BARS

DESIGN INFORMATION		Symbol	Units	Bar size				
				10 M	15 M	20 M	25 M	30 M
Nominal bar diameter		<i>d</i>	mm (in.)	11.3 (0.445)	16.0 (0.630)	19.5 (0.768)	25.2 (0.992)	29.9 (1.177)
Bar effective cross-sectional area		<i>A<sub>se</sub></i>	mm <sup>2</sup> (in. <sup>2</sup> )	100.3 (0.155)	201.1 (0.312)	298.6 (0.463)	498.8 (0.773)	702.2 (1.088)
CSA G30	Nominal strength as governed by steel strength	<i>N<sub>sa</sub></i>	kN (lb)	54.0 (12,175)	108.5 (24,408)	161.5 (36,255)	270.0 (60,548)	380.0 (85,239)
		<i>V<sub>sa</sub></i>	kN (lb)	32.5 (7,305)	65.0 (14,645)	97.0 (21,753)	161.5 (36,329)	227.5 (51,144)
	Reduction for seismic shear	<i>α<sub>V,seis</sub></i>	-	0.70				
	Strength reduction factor for tension <sup>1</sup>	<i>φ</i>	-	0.65				
				0.60				
Strength reduction factor for shear <sup>1</sup>		<i>φ</i>	-	0.60				

For SI: 1 inch ≡ 25.4 mm, 1 lbf = 4.448 N, 1 psi = 0.006897 MPa.

For pound-inch units: 1 mm = 0.03937 inches, 1 N = 0.2248 lbf, 1 MPa = 145.0 psi

<sup>1</sup> For use with the load combinations of ACI 318-19 and ACI 318-14 5.3 or ACI 318-11 9.2, as set forth in ACI 318-19 17.5.3, ACI 318-14 17.3.3 or ACI 318-11 D.4.3. Values correspond to a brittle steel element.

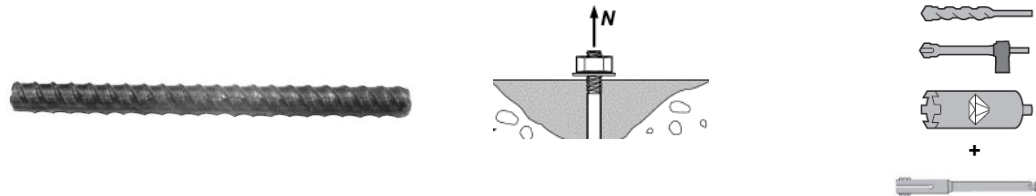

Canadian Reinforcing Bars

Concrete Breakout Strength

Carbide Bit or Hilti Hollow Carbide Bit or Diamond Core Bit with Roughening Tool

TABLE 24—CONCRETE BREAKOUT DESIGN INFORMATION FOR CANADIAN METRIC REINFORCING BARS IN HOLES DRILLED WITH A HAMMER DRILL AND CARBIDE BIT (OR HILTI HOLLOW CARBIDE DRILL BIT) OR CORE DRILLED WITH A DIAMOND CORE BIT AND ROUGHENED WITH A HILTI ROUGHENING TOOL<sup>1</sup>

DESIGN INFORMATION		Symbol	Units	Bar size				
				10 M	15 M	20 M	25 M	30 M
Effectiveness factor for cracked concrete		<i>k<sub>c,cr</sub></i>	SI (in-lb)	7.1 (17)				
Effectiveness factor for uncracked concrete		<i>k<sub>c,uncr</sub></i>	SI (in-lb)	10 (24)				
Minimum Embedment		<i>h<sub>ef,min</sub></i>	mm (in.)	70 (2.8)	80 (3.1)	90 (3.5)	101 (4.0)	120 (4.7)
Maximum Embedment		<i>h<sub>ef,max</sub></i>	mm (in.)	226 (8.9)	320 (12.6)	390 (15.4)	504 (19.8)	598 (23.5)
Min. bar spacing <sup>3</sup>		<i>s<sub>min</sub></i>	mm (in.)	57 (2.2)	80 (3.1)	98 (3.8)	126 (5.0)	150 (5.9)
Min. edge distance <sup>3</sup>		<i>c<sub>min</sub></i>	mm (in.)	5 <i>d</i> ; or see Section 4.1.9.2 of this report for design with reduced minimum edge distances				
Minimum concrete thickness		<i>h<sub>min</sub></i>	mm (in.)	<i>h<sub>ef</sub></i> + 30 ( <i>h<sub>ef</sub></i> + 1 <sup>1</sup> / <sub>4</sub> )	<i>h<sub>ef</sub></i> + 2 <i>d<sub>o</sub></i> <sup>(4)</sup>			
Critical edge distance – splitting (for uncracked concrete)		<i>c<sub>ac</sub></i>	-	See Section 4.1.10.2 of this report.				
Strength reduction factor for tension, concrete failure modes, Condition B (supplemental reinforcement not present) <sup>2</sup>		<i>φ</i>	-	0.65				
Strength reduction factor for shear, concrete failure modes, Condition B (supplemental reinforcement not present) <sup>2</sup>		<i>φ</i>	-	0.70				

For SI: 1 inch ≡ 25.4 mm, 1 lbf = 4.448 N, 1 psi = 0.006897 MPa.

For pound-inch units: 1 mm = 0.03937 inches, 1 N = 0.2248 lbf, 1 MPa = 145.0 psi

<sup>1</sup> Additional setting information is described in Figure 6, Manufacturers Printed Installation Instructions (MPII).

<sup>2</sup> The strength reduction factor applies when the load combinations from the IBC or ACI 318 are used and the requirements of ACI 318-19 17.5.3, ACI 318-14 17.3.3 or ACI 318-11 D.4.3, as applicable, are met. If the load combinations of ACI 318-11 Appendix C are used, the appropriate strength reduction factor must be determined in accordance with ACI 318-11 D.4.4.

<sup>3</sup> For installations with 1<sup>3</sup>/<sub>4</sub>-inch edge distance, refer to Section 4.1.9.2 for spacing and maximum torque requirements.

<sup>4</sup>  $d_0$  = hole diameter.

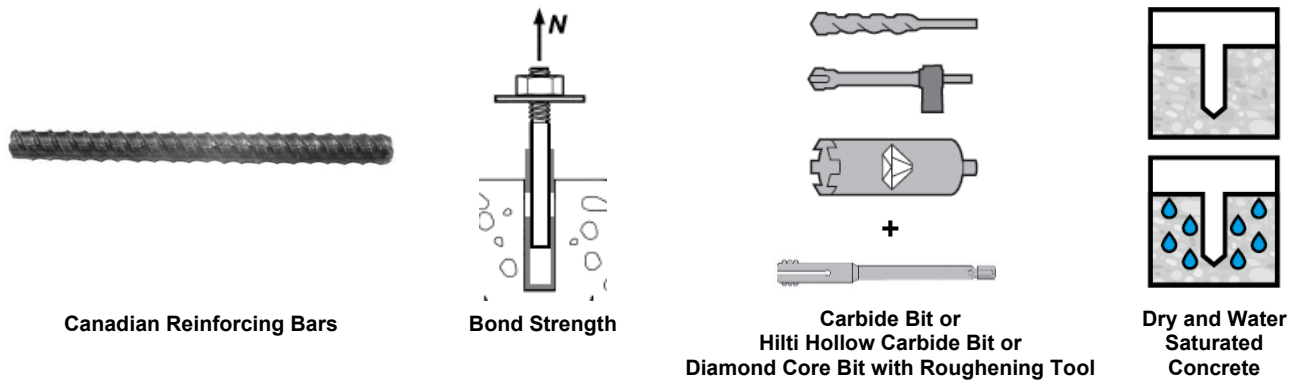

Canadian Reinforcing Bars

Bond Strength

Carbide Bit or Hilti Hollow Carbide Bit or Diamond Core Bit with Roughening Tool

Dry and Water Saturated Concrete

**TABLE 25—BOND STRENGTH DESIGN INFORMATION FOR CANADIAN METRIC REINFORCING BARS IN HOLES DRILLED WITH A HAMMER DRILL AND CARBIDE BIT (OR HILTI HOLLOW CARBIDE DRILL BIT) OR CORE DRILLED WITH A DIAMOND CORE BIT AND ROUGHENED WITH A HILTI ROUGHENING TOOL<sup>1</sup>**

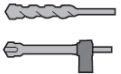
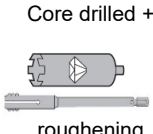
DESIGN INFORMATION		Symbol	Units	Bar size				
				10 M	15 M	20 M	25 M	30 M
Minimum Embedment		$h_{ef,min}$	mm (in.)	70 (2.8)	80 (3.1)	90 (3.5)	101 (4.0)	120 (4.7)
Maximum Embedment		$h_{ef,max}$	mm (in.)	226 (8.9)	320 (12.6)	390 (15.4)	504 (19.8)	598 (23.5)
Temperature range A <sup>2</sup>	Characteristic bond strength in cracked concrete	$\tau_{k,cr}$	MPa (psi)	7.4 (1,075)	7.5 (1,085)	7.5 (1,095)	5.8 (840)	5.9 (850)
	Characteristic bond strength in uncracked concrete	$\tau_{k,uncr}$	MPa (psi)	10.8 (1,560)	10.8 (1,560)	10.8 (1,560)	10.8 (1,560)	10.8 (1,560)
Temperature range B <sup>2</sup>	Characteristic bond strength in cracked concrete	$\tau_{k,cr}$	MPa (psi)	7.4 (1,075)	7.5 (1,085)	7.5 (1,095)	5.8 (840)	5.9 (850)
	Characteristic bond strength in uncracked concrete	$\tau_{k,uncr}$	MPa (psi)	10.8 (1,560)	10.8 (1,560)	10.8 (1,560)	10.8 (1,560)	10.8 (1,560)
Temperature range C <sup>2</sup>	Characteristic bond strength in cracked concrete	$\tau_{k,cr}$	MPa (psi)	6.1 (885)	6.2 (895)	6.2 (900)	4.8 (690)	4.8 (700)
	Characteristic bond strength in uncracked concrete	$\tau_{k,uncr}$	MPa (psi)	8.8 (1,280)	8.8 (1,280)	8.8 (1,280)	8.8 (1,280)	8.8 (1,280)
Permissible installation conditions	Dry and water saturated concrete	Anchor Category	-	1				
		$\phi_d, \phi_{ws}$	-	0.65				
Reduction for seismic tension	 Hammer drilled	$\alpha_{N,seis}$	-	0.80		0.85		0.97
	 Core drilled + roughening	$\alpha_{N,seis}$	-	N/A	0.71	0.77	N/A	

For SI: 1 inch = 25.4 mm, 1 lbf = 4.448 N, 1 psi = 0.006897 MPa.  
For pound-inch units: 1 mm = 0.03937 inches, 1 N = 0.2248 lbf, 1 MPa = 145.0 psi

<sup>1</sup> Bond strength values correspond to concrete compressive strength  $f_c = 2,500$  psi (17.2 MPa). For concrete compressive strength,  $f_c$ , between 2,500 psi (17.2 MPa) and 8,000 psi (55.2 MPa), the tabulated characteristic bond strength may be increased by a factor of  $(f_c / 2,500)^{0.1}$  [For SI:  $(f_c / 17.2)^{0.1}$ ]. See Section 4.1.4 of this report for bond strength determination.

<sup>2</sup> Temperature range A: Maximum short term temperature = 130°F (55°C), Maximum long term temperature = 110°F (43°C).

Temperature range B: Maximum short term temperature = 176°F (80°C), Maximum long term temperature = 110°F (43°C).

Temperature range C: Maximum short term temperature = 248°F (120°C), Maximum long term temperature = 162°F (72°C).

Short term elevated concrete temperatures are those that occur over brief intervals, e.g., as a result of diurnal cycling. Long term concrete temperatures are roughly constant over significant periods of time.

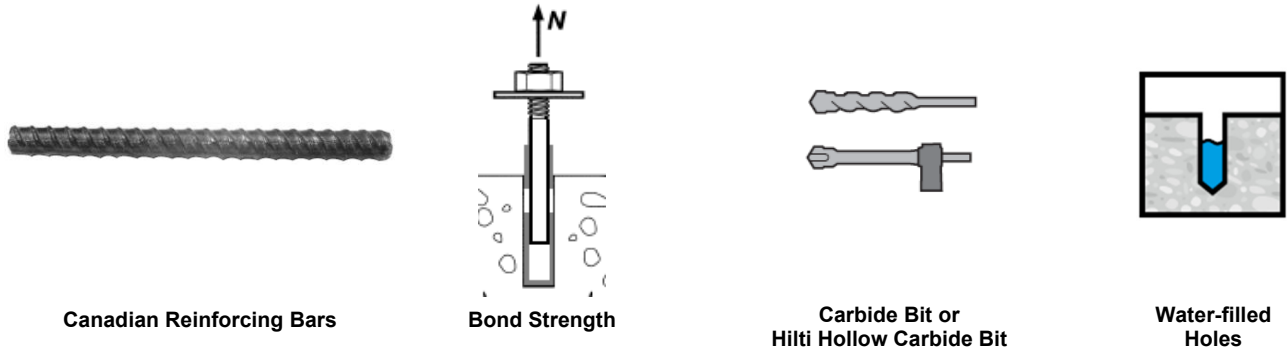

**TABLE 26—BOND STRENGTH DESIGN INFORMATION FOR CANADIAN METRIC REINFORCING BARS IN HOLES DRILLED WITH A HAMMER DRILL AND CARBIDE BIT (OR HILTI HOLLOW CARBIDE DRILL BIT)**

DESIGN INFORMATION		Symbol	Units	Bar size				
				10 M	15 M	20 M	25 M	30 M
Minimum Embedment		$h_{ef,min}$	mm (in.)	70 (2.8)	80 (3.1)	90 (3.5)	101 (4.0)	120 (4.7)
Maximum Embedment		$h_{ef,max}$	mm (in.)	226 (8.9)	320 (12.6)	390 (15.4)	504 (19.8)	598 (23.5)
Temperature range A <sup>2</sup>	Characteristic bond strength in cracked concrete	$\tau_{k,cr}$	MPa (psi)	7.3 (1,050)	7.4 (1,070)	7.4 (1,070)	5.7 (820)	5.8 (830)
	Characteristic bond strength in uncracked concrete	$\tau_{k,uncr}$	MPa (psi)	10.5 (1,520)	10.5 (1,520)	10.5 (1,520)	10.5 (1,520)	10.5 (1,520)
Temperature range B <sup>2</sup>	Characteristic bond strength in cracked concrete	$\tau_{k,cr}$	MPa (psi)	7.3 (1,050)	7.4 (1,070)	7.4 (1,070)	5.7 (820)	5.8 (830)
	Characteristic bond strength in uncracked concrete	$\tau_{k,uncr}$	MPa (psi)	10.5 (1,520)	10.5 (1,520)	10.5 (1,520)	10.5 (1,520)	10.5 (1,520)
Temperature range C <sup>2</sup>	Characteristic bond strength in cracked concrete	$\tau_{k,cr}$	MPa (psi)	6.0 (865)	6.1 (875)	6.1 (875)	4.7 (680)	6.0 (865)
	Characteristic bond strength in uncracked concrete	$\tau_{k,uncr}$	MPa (psi)	8.6 (1,250)	8.6 (1,250)	8.6 (1,250)	8.6 (1,250)	8.6 (1,250)
Permissible installation conditions	Water-filled Holes 	Anchor Category	-	3				
		$\phi_{wt}$	-	0.45				
Reduction for seismic tension	 Hammer drilled	$\alpha_{N,seis}$	-	0.80			0.85	0.97

For SI: 1 inch = 25.4 mm, 1 lbf = 4.448 N, 1 psi = 0.006897 MPa.  
For pound-inch units: 1 mm = 0.03937 inches, 1 N = 0.2248 lbf, 1 MPa = 145.0 psi

<sup>1</sup> Bond strength values correspond to concrete compressive strength  $f'_c = 2,500$  psi (17.2 MPa). For concrete compressive strength,  $f'_c$ , between 2,500 psi (17.2 MPa) and 8,000 psi (55.2 MPa), the tabulated characteristic bond strength may be increased by a factor of  $(f'_c / 2,500)^{0.1}$  [For SI:  $(f'_c / 17.2)^{0.1}$ ]. See Section 4.1.4 of this report for bond strength determination.

<sup>2</sup> Temperature range A: Maximum short term temperature = 130°F (55°C), Maximum long term temperature = 110°F (43°C).  
Temperature range B: Maximum short term temperature = 176°F (80°C), Maximum long term temperature = 110°F (43°C).  
Temperature range C: Maximum short term temperature = 248°F (120°C), Maximum long term temperature = 162°F (72°C).  
Short term elevated concrete temperatures are those that occur over brief intervals, e.g., as a result of diurnal cycling. Long term concrete temperatures are roughly constant over significant periods of time.





Fractional and Metric HIS-N and HIS-RN Internal Threaded Insert

Steel Strength

TABLE 27—STEEL DESIGN INFORMATION FOR FRACTIONAL AND METRIC HIS-N AND HIS-RN THREADED INSERTS<sup>1</sup>

DESIGN INFORMATION	Symbol	Units	Nominal Bolt/Cap Screw Diameter (in.) Fractional				Units	Nominal Bolt/Cap Screw Diameter (mm) Metric					
			<sup>3</sup> / <sub>8</sub>	<sup>1</sup> / <sub>2</sub>	<sup>5</sup> / <sub>8</sub>	<sup>3</sup> / <sub>4</sub>		8	10	12	16	20	
HIS Insert O.D.	<i>D</i>	in. (mm)	0.65 (16.5)	0.81 (20.5)	1.00 (25.4)	1.09 (27.6)	mm (in.)	12.5 (0.49)	16.5 (0.65)	20.5 (0.81)	25.4 (1.00)	27.6 (1.09)	
HIS insert length	<i>L</i>	in. (mm)	4.33 (110)	4.92 (125)	6.69 (170)	8.07 (205)	mm (in.)	90 (3.54)	110 (4.33)	125 (4.92)	170 (6.69)	205 (8.07)	
Bolt effective cross-sectional area	<i>A<sub>se</sub></i>	in. <sup>2</sup> (mm <sup>2</sup> )	0.0775 (50)	0.1419 (92)	0.2260 (146)	0.3345 (216)	mm <sup>2</sup> (in. <sup>2</sup> )	36.6 (0.057)	58 (0.090)	84.3 (0.131)	157 (0.243)	245 (0.380)	
HIS insert effective cross-sectional area	<i>A<sub>insert</sub></i>	in. <sup>2</sup> (mm <sup>2</sup> )	0.178 (115)	0.243 (157)	0.404 (260)	0.410 (265)	mm <sup>2</sup> (in. <sup>2</sup> )	51.5 (0.080)	108 (0.167)	169.1 (0.262)	256.1 (0.397)	237.6 (0.368)	
ASTM A193 B7	Nominal steel strength – ASTM A193 B7 <sup>3</sup> bolt/cap screw	<i>N<sub>sa</sub></i>	lb (kN)	9,690 (43.1)	17,740 (78.9)	28,250 (125.7)	41,815 (186.0)	kN (lb)	-	-	-	-	-
		<i>V<sub>sa</sub></i>	lb (kN)	5,815 (25.9)	10,645 (47.3)	16,950 (75.4)	25,090 (111.6)	kN (lb)	-	-	-	-	-
	Nominal steel strength – HIS-N insert	<i>N<sub>sa</sub></i>	lb (kN)	12,650 (56.3)	16,195 (72.0)	26,925 (119.8)	27,360 (121.7)	kN (lb)	-	-	-	-	-
ASTM A193 Grade B8M SS	Nominal steel strength – ASTM A193 Grade B8M SS bolt/cap screw	<i>N<sub>sa</sub></i>	lb (kN)	8,525 (37.9)	15,610 (69.4)	24,860 (110.6)	36,795 (163.7)	kN (lb)	-	-	-	-	-
		<i>V<sub>sa</sub></i>	lb (kN)	5,115 (22.8)	9,365 (41.7)	14,915 (66.3)	22,075 (98.2)	kN (lb)	-	-	-	-	-
	Nominal steel strength – HIS-RN insert	<i>N<sub>sa</sub></i>	lb (kN)	17,165 (76.3)	23,430 (104.2)	38,955 (173.3)	39,535 (175.9)	kN (lb)	-	-	-	-	-
ISO 898-1 Class 8.8	Nominal steel strength – ISO 898-1 Class 8.8 bolt/cap screw	<i>N<sub>sa</sub></i>	lb (kN)	-	-	-	-	kN (lb)	29.5 (6,582)	46.5 (10,431)	67.5 (15,161)	125.5 (28,236)	196.0 (44,063)
		<i>V<sub>sa</sub></i>	lb (kN)	-	-	-	-	kN (lb)	17.5 (3,949)	28.0 (6,259)	40.5 (9,097)	75.5 (16,942)	117.5 (26,438)
	Nominal steel strength – HIS-N insert	<i>N<sub>sa</sub></i>	lb (kN)	-	-	-	-	kN (lb)	25.0 (5,669)	53.0 (11,894)	78.0 (17,488)	118.0 (26,483)	110.0 (24,573)
ISO 3506-1 Class A4-70 Stainless	Nominal steel strength – ISO 3506-1 Class A4-70 Stainless bolt/cap screw	<i>N<sub>sa</sub></i>	lb (kN)	-	-	-	-	kN (lb)	25.5 (5,760)	40.5 (9,127)	59.0 (13,266)	110.0 (24,706)	171.5 (38,555)
		<i>V<sub>sa</sub></i>	lb (kN)	-	-	-	-	kN (lb)	15.5 (3,456)	24.5 (5,476)	35.5 (7,960)	66.0 (14,824)	103.0 (23,133)
	Nominal steel strength – HIS-RN insert	<i>N<sub>sa</sub></i>	lb (kN)	-	-	-	-	kN (lb)	36.0 (8,099)	75.5 (16,991)	118.5 (26,612)	179.5 (40,300)	166.5 (37,394)
Reduction for seismic shear	$\alpha_{V,seis}$	-	0.94				-	0.94					
Strength reduction factor for tension <sup>2</sup>	$\phi$	-	0.65				-	0.65					
Strength reduction factor for shear <sup>2</sup>	$\phi$	-	0.60				-	0.60					

For SI: 1 inch = 25.4 mm, 1 lbf = 4.448 N, 1 psi = 0.006897MPa.  
For pound-inch units: 1 mm = 0.03937 inches, 1 N = 0.2248 lbf, 1 MPa = 145.0 psi

<sup>1</sup> Values provided for common rod material types based on specified strengths and calculated in accordance with ACI 318-19 Eq. (17.6.1.2), ACI 318-14 Eq. (17.4.1.2), ACI 318-11 Eq. (D-2) and Eq. (D-29). Nuts and washers must be appropriate for the rod.  
<sup>2</sup> The strength reduction factor applies when the load combinations from the IBC or ACI 318 are used and the requirements of ACI 318-19 17.5.3, ACI 318-14 17.3.3 or ACI 318-11 D.4.3, as applicable, are met. If the load combinations of ACI 318-11 Appendix C are used, the appropriate strength reduction factor must be determined in accordance with ACI 318-11 D.4.4.  
<sup>3</sup> For the calculation of the design steel strength in tension and shear for the bolt or screw, the  $\phi$  factor for ductile steel failure according to ACI 318-19 17.5.3, ACI 318-14 17.3.3 or ACI 318-11 D.4.3 can be used.

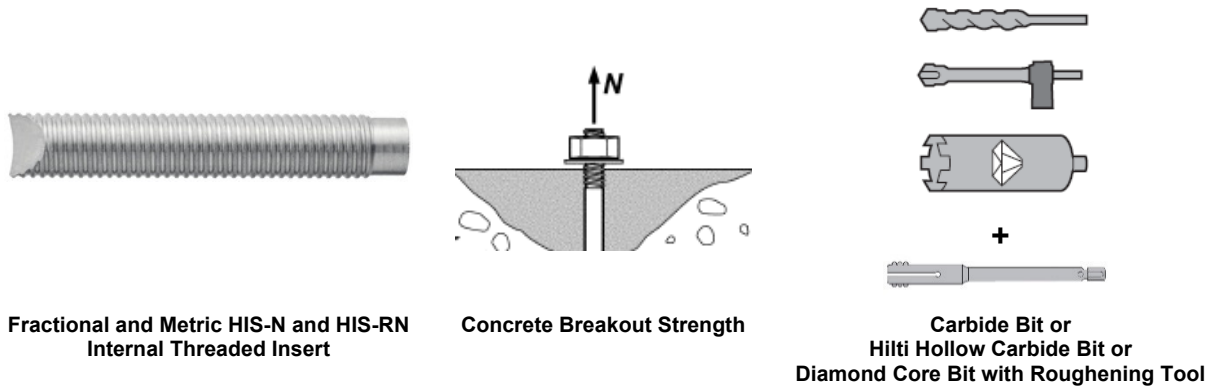
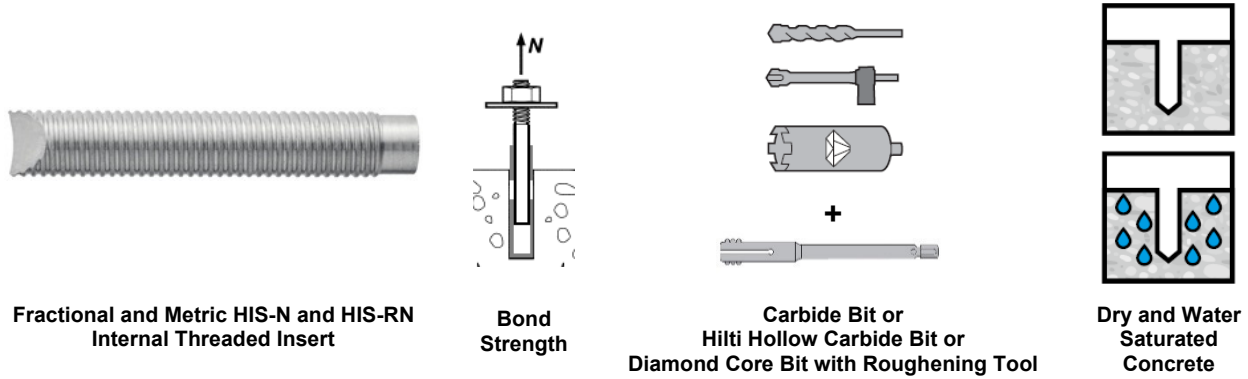

**TABLE 28—CONCRETE BREAKOUT DESIGN INFORMATION FOR FRACTIONAL AND METRIC HILTI HIS-N AND HIS-RN INSERTS IN HOLES DRILLED WITH A HAMMER DRILL AND CARBIDE BIT (OR HILTI HOLLOW CARBIDE DRILL BIT) OR CORE DRILLED WITH A DIAMOND CORE BIT AND ROUGHENED WITH A HILTI ROUGHENING TOOL<sup>1</sup>**

DESIGN INFORMATION	Symbol	Units	Nominal Bolt/Cap Screw Diameter (in.) Fractional				Units	Nominal Bolt/Cap Screw Diameter (mm) Metric				
			3/8	1/2	5/8	3/4		8	10	12	16	20
Effectiveness factor for cracked concrete	$k_{c,cr}$	in-lb (SI)	17 (7.1)				SI (in-lb)	7.1 (17)				
Effectiveness factor for uncracked concrete	$k_{c,un-cr}$	in-lb (SI)	24 (10)				SI (in-lb)	10 (24)				
Effective embedment depth	$h_{ef}$	in. (mm)	4 <sup>3/8</sup> (110)	5 (125)	6 <sup>3/4</sup> (170)	8 <sup>1/8</sup> (205)	mm (in.)	90 (3.5)	110 (4.3)	125 (4.9)	170 (6.7)	205 (8.1)
Min. anchor spacing <sup>3</sup>	$s_{min}$	in. (mm)	3 <sup>1/4</sup> (83)	4 (102)	5 (127)	5 <sup>1/2</sup> (140)	mm (in.)	63 (2.5)	83 (3.25)	102 (4.0)	127 (5.0)	140 (5.5)
Min. edge distance <sup>3</sup>	$c_{min}$	in. (mm)	3 <sup>1/4</sup> (83)	4 (102)	5 (127)	5 <sup>1/2</sup> (140)	mm (in.)	63 (2.5)	83 (3.25)	102 (4.0)	127 (5.0)	140 (5.5)
Minimum concrete thickness	$h_{min}$	in. (mm)	5.9 (150)	6.7 (170)	9.1 (230)	10.6 (270)	mm (in.)	120 (4.7)	150 (5.9)	170 (6.7)	230 (9.1)	270 (10.6)
Critical edge distance – splitting (for uncracked concrete)	$c_{ac}$	-	See Section 4.1.10.2 of this report				-	See Section 4.1.10.2 of this report				
Strength reduction factor for tension, concrete failure modes, Condition B (supplemental reinforcement not present) <sup>2</sup>	$\phi$	-	0.65				-	0.65				
Strength reduction factor for shear, concrete failure modes, Condition B (supplemental reinforcement not present) <sup>2</sup>	$\phi$	-	0.70				-	0.70				

For SI: 1 inch ≡ 25.4 mm, 1 lbf = 4.448 N, 1 psi = 0.006897MPa.  
For pound-inch units: 1 mm = 0.03937 inches, 1 N = 0.2248 lbf, 1 MPa = 145.0 psi

<sup>1</sup> Additional setting information is described in Figure 6, Manufacturers Printed Installation Instructions (MPII).  
<sup>2</sup> The strength reduction factor applies when the load combinations from the IBC or ACI 318 are used and the requirements of ACI 318-19 17.5.3, ACI 318-14 17.3.3 or ACI 318-11 D.4.3, as applicable, are met. If the load combinations of ACI 318-11 Appendix C are used, the appropriate strength reduction factor must be determined in accordance with ACI 318-11 D.4.4.  
<sup>3</sup> For installations with 1<sup>3/4</sup>-inch edge distance, refer to Section 4.1.9.2 for spacing and maximum torque requirements.



Fractional and Metric HIS-N and HIS-RN Internal Threaded Insert

Bond Strength

Carbide Bit or Hilti Hollow Carbide Bit or Diamond Core Bit with Roughening Tool

Dry and Water Saturated Concrete

TABLE 29—BOND STRENGTH DESIGN INFORMATION FOR FRACTIONAL AND METRIC HILTI HIS-N AND HIS-RN INSERTS IN HOLES DRILLED WITH A HAMMER DRILL AND CARBIDE BIT (OR HILTI HOLLOW CARBIDE DRILL BIT)<sup>1</sup>

DESIGN INFORMATION		Symbol	Units	Nominal Bolt/Cap Screw Diameter (in.) Fractional				Units	Nominal Bolt/Cap Screw Diameter (mm) Metric				
				3/8	1/2	5/8	3/4		8	10	12	16	20
Effective embedment depth		$h_{ef}$	in. (mm)	4 <sup>3</sup> / <sub>8</sub> (110)	5 (125)	6 <sup>3</sup> / <sub>4</sub> (170)	8 <sup>1</sup> / <sub>8</sub> (205)	mm (in.)	90 (3.5)	110 (4.3)	125 (4.9)	170 (6.7)	205 (8.1)
HIS Insert O.D.		$D$	in. (mm)	0.65 (16.5)	0.81 (20.5)	1.00 (25.4)	1.09 (27.6)	mm (in.)	12.5 (0.49)	16.5 (0.65)	20.5 (0.81)	25.4 (1.00)	27.6 (1.09)
Temperature range A <sup>2</sup>	Characteristic bond strength in cracked concrete	$\tau_{k,cr}$	psi (MPa)	870 (6.0)	890 (6.1)	910 (6.3)	920 (6.3)	MPa (psi)	5.9 (850)	6.0 (870)	6.1 (890)	6.3 (910)	6.3 (920)
	Characteristic bond strength in uncracked concrete	$\tau_{k,uncr}$	psi (MPa)	1,950 (13.5)	1,950 (13.5)	1,950 (13.5)	1,950 (13.5)	MPa (psi)	13.5 (1,950)	13.5 (1,950)	13.5 (1,950)	13.5 (1,950)	13.5 (1,950)
Temperature range B <sup>2</sup>	Characteristic bond strength in cracked concrete	$\tau_{k,cr}$	psi (MPa)	870 (6.0)	890 (6.1)	910 (6.3)	920 (6.3)	MPa (psi)	5.9 (850)	6.0 (870)	6.1 (890)	6.3 (910)	6.3 (920)
	Characteristic bond strength in uncracked concrete	$\tau_{k,uncr}$	psi (MPa)	1,950 (13.5)	1,950 (13.5)	1,950 (13.5)	1,950 (13.5)	MPa (psi)	13.5 (1,950)	13.5 (1,950)	13.5 (1,950)	13.5 (1,950)	13.5 (1,950)
Temperature range C <sup>2</sup>	Characteristic bond strength in cracked concrete	$\tau_{k,cr}$	psi (MPa)	715 (4.9)	730 (5.0)	750 (5.2)	755 (5.2)	MPa (psi)	4.8 (695)	4.9 (715)	5.0 (730)	5.2 (750)	5.2 (755)
	Characteristic bond strength in uncracked concrete	$\tau_{k,uncr}$	psi (MPa)	1,600 (11.0)	1,600 (11.0)	1,600 (11.0)	1,600 (11.0)	MPa (psi)	11.0 (1,600)	11.0 (1,600)	11.0 (1,600)	11.0 (1,600)	11.0 (1,600)
Permissible installation conditions	Dry and water saturated conc.	Anchor Category	-	1				-	1				
		$\phi_d, \phi_{ws}$	-	0.65				-	0.65				
Reduction for seismic tension	Hammer drilled	$\alpha_{N,seis}$	-	0.92				-	0.92				
	Core drilled + roughening	$\alpha_{N,seis}$	-	0.81	0.88	0.92	0.76	-	N/A	0.81	0.88	0.92	0.76

For SI: 1 inch ≡ 25.4 mm, 1 lbf = 4.448 N, 1 psi = 0.006897 MPa.  
 For pound-inch units: 1 mm = 0.03937 inches, 1 N = 0.2248 lbf, 1 MPa = 145.0 psi

<sup>1</sup> Bond strength values correspond to concrete compressive strength  $f_c = 2,500$  psi (17.2 MPa). For concrete compressive strength,  $f_c$ , between 2,500 psi (17.2 MPa) and 8,000 psi (55.2 MPa), the tabulated characteristic bond strength may be increased by a factor of  $(f_c / 2,500)^{0.1}$  for uncracked concrete,  $[(f_c / 17.2)^{0.1}]$  and  $(f_c / 2,500)^{0.3}$  for cracked concrete, [For SI:  $(f_c / 17.2)^{0.3}$ ]. See Section 4.1.4 of this report for bond strength determination.

<sup>2</sup> Temperature range A: Maximum short term temperature = 130°F (55°C), Maximum long term temperature = 110°F (43°C).  
 Temperature range B: Maximum short term temperature = 176°F (80°C), Maximum long term temperature = 110°F (43°C).

Temperature range C: Maximum short term temperature = 248°F (120°C), Maximum long term temperature = 162°F (72°C). Short term elevated concrete temperatures are those that occur over brief intervals, e.g., as a result of diurnal cycling. Long term concrete temperatures are roughly constant over significant periods of time.



HILTI HIT-HY 200 V3 FOIL PACK AND MIXING NOZZLE

HILTI DISPENSER

HILTI TE-CD OR TE-YD HOLLOW CARBIDE DRILL BIT

HILTI TE-YRT ROUGHENING TOOL

ANCHORING ELEMENTS

FIGURE 5—HILTI HIT-HY 200 V3 ANCHORING SYSTEM

TABLE 30—DEVELOPMENT LENGTH FOR U.S. CUSTOMARY UNIT REINFORCING BARS IN HOLES DRILLED WITH A HAMMER DRILL AND CARBIDE BIT OR HILTI HOLLOW CARBIDE BIT<sup>1,2,4</sup>

DESIGN INFORMATION	Symbol	Criteria Section of Reference Standard	Units	Bar size							
				#3	#4	#5	#6	#7	#8	#9	#10
Nominal reinforcing bar diameter	$d_b$	ASTM A615/A706	in. (mm)	0.375 (9.5)	0.500 (12.7)	0.625 (15.9)	0.750 (19.1)	0.875 (22.2)	1.000 (25.4)	1.128 (28.7)	1.270 (32.3)
Nominal bar area	$A_b$	ASTM A615/A706	in <sup>2</sup> (mm <sup>2</sup> )	0.11 (71)	0.20 (129)	0.31 (199)	0.44 (284)	0.60 (387)	0.79 (510)	1.00 (645)	1.27 (819)
Development length for $f_y = 60$ ksi and $f'_c = 2,500$ psi (normal weight concrete) <sup>3</sup>	$l_d$	ACI 318-19 25.4.2.4 ACI 318-14 25.4.2.3 ACI 318-11 12.2.3	in. (mm)	12.0 (304.8)	14.4 (365.8)	18.0 (457.2)	21.6 (548.6)	31.5 (800.1)	36.0 (914.4)	40.6 (1031.4)	45.7 (1161.3)
Development length for $f_y = 60$ ksi and $f'_c = 4,000$ psi (normal weight concrete) <sup>3</sup>	$l_d$	ACI 318-19 25.4.2.4 ACI 318-14 25.4.2.3 ACI 318-11 12.2.3	in. (mm)	12.0 (304.8)	12.0 (304.8)	14.2 (361.4)	17.1 (433.7)	24.9 (632.5)	28.5 (722.9)	32.1 (815.4)	36.1 (918.1)

For SI: 1 inch  $\equiv$  25.4 mm, 1 lbf = 4.448 N, 1 psi = 0.006897 MPa.  
For pound-inch units: 1 mm = 0.03937 inches, 1 N = 0.2248 lbf, 1 MPa = 145.0 psi

<sup>1</sup> Development lengths valid for static, wind, and earthquake loads (SDC A and B).

<sup>2</sup> Development lengths in SDC C through F must comply with ACI 318-19 and ACI 318-14 Chapter 18 or ACI 318-11 Chapter 21 and section 4.2.4 of this report.

<sup>3</sup> For sand-lightweight concrete, increase development length by 33%, unless the provisions of ACI 318-19 25.4.2.5, ACI 318-14 25.4.2.4 or ACI 318-11 12.2.4 (d) are met to permit  $\lambda > 0.75$ .

<sup>4</sup>  $\left( \frac{c_b + K_{tr}}{d_b} \right) = 2.5$ ,  $\psi_t = 1.0$ ,  $\psi_e = 1.0$ ,  $\psi_s = 0.8$  for  $d_b \leq \#6$ , 1.0 for  $d_b > \#6$ .

**TABLE 31—DEVELOPMENT LENGTH FOR EU METRIC REINFORCING BARS IN HOLES DRILLED WITH A HAMMER DRILL AND CARBIDE BIT OR HILTI HOLLOW CARBIDE BIT <sup>1,2,4</sup>**

DESIGN INFORMATION	Symbol	Criteria Section of Reference Standard	Units	Bar size						
				8	10	12	16	20	25	32
Nominal reinforcing bar diameter	$d_b$	BS 4449: 2005	mm (in.)	8 (0.315)	10 (0.394)	12 (0.472)	16 (0.630)	20 (0.787)	25 (0.984)	32 (1.260)
Nominal bar area	$A_b$	BS 4449: 2005	mm <sup>2</sup> (in <sup>2</sup> )	50.3 (0.08)	78.5 (0.12)	113.1 (0.18)	201.1 (0.31)	314.2 (0.49)	490.9 (0.76)	804.2 (1.25)
Development length for $f_y = 72.5$ ksi and $f'_c = 2,500$ psi (normal weight concrete) <sup>3</sup>	$l_d$	ACI 318-19 25.4.2.4 <sup>5</sup> ACI 318-14 25.4.2.3 ACI 318-11 12.2.3	mm (in.)	305 (12.0)	348 (13.7)	417 (16.4)	556 (21.9)	871 (34.3)	1087 (42.8)	1392 (54.8)
Development length for $f_y = 72.5$ ksi and $f'_c = 4,000$ psi (normal weight concrete) <sup>3</sup>	$l_d$	ACI 318-19 25.4.2.4 <sup>5</sup> ACI 318-14 25.4.2.3 ACI 318-11 12.2.3	mm (in.)	305 (12.0)	305 (12.0)	330 (13.0)	439 (17.3)	688 (27.1)	859 (33.8)	1100 (43.3)

For SI: 1 inch  $\equiv$  25.4 mm, 1 lbf = 4.448 N, 1 psi = 0.006897 MPa.  
For pound-inch units: 1 mm = 0.03937 inches, 1 N = 0.2248 lbf, 1 MPa = 145.0 psi

<sup>1</sup>Development lengths valid for static, wind, and earthquake loads (SDC A and B).

<sup>2</sup>Development lengths in SDC C through F must comply with ACI 318-19 and ACI 318-14 Chapter 18 or ACI 318-11 Chapter 21 and section 4.2.4 of this report.

<sup>3</sup>For sand-lightweight concrete, increase development length by 33%, unless the provisions of ACI 318-19 25.4.2.5, ACI 318-14 25.4.2.4 or ACI 318-11 12.2.4 (d) are met to permit  $\lambda > 0.75$ .

<sup>4</sup> $\left(\frac{c_b + K_{tr}}{d_b}\right) = 2.5$ ,  $\psi_t = 1.0$ ,  $\psi_e = 1.0$ ,  $\psi_s = 0.8$  for  $d_b < 20$ mm, 1.0 for  $d_b \geq 20$ mm.

<sup>5</sup> $l_d$  must be increased by 9.5% to account for  $\psi_g$  in ACI 318-19 25.4.2.4.  $\psi_g$  has been interpolated from Table 25.4.2.5 of ACI 318-10 for  $f_y = 72.5$  ksi.

**TABLE 32—DEVELOPMENT LENGTH FOR CANADIAN METRIC REINFORCING BARS IN HOLES DRILLED WITH A HAMMER DRILL AND CARBIDE BIT OR HILTI HOLLOW CARBIDE BIT <sup>1,2,4</sup>**

DESIGN INFORMATION	Symbol	Criteria Section of Reference Standard	Units	Bar size				
				10M	15M	20M	25M	30M
Nominal reinforcing bar diameter	$d_b$	CAN/CSA-G30.18 Gr. 400	mm (in.)	11.3 (0.445)	16.0 (0.630)	19.5 (0.768)	25.2 (0.992)	29.9 (1.177)
Nominal bar area	$A_b$	CAN/CSA-G30.18 Gr. 400	mm <sup>2</sup> (in <sup>2</sup> )	100.3 (0.16)	201.1 (0.31)	298.6 (0.46)	498.8 (0.77)	702.2 (1.09)
Development length for $f_y = 58$ ksi and $f'_c = 2,500$ psi (normal weight concrete) <sup>3</sup>	$l_d$	ACI 318-19 25.4.2.4 ACI 318-14 25.4.2.3 ACI 318-11 12.2.3	mm (in.)	315 (12.4)	445 (17.5)	678 (26.7)	876 (34.5)	1041 (41.0)
Development length for $f_y = 58$ ksi and $f'_c = 4,000$ psi (normal weight concrete) <sup>3</sup>	$l_d$	ACI 318-19 25.4.2.4 ACI 318-14 25.4.2.3 ACI 318-11 12.2.3	mm (in.)	305 (12.0)	353 (13.9)	536 (21.1)	693 (27.3)	823 (32.4)

For SI: 1 inch  $\equiv$  25.4 mm, 1 lbf = 4.448 N, 1 psi = 0.006897 MPa.  
For pound-inch units: 1 mm = 0.03937 inches, 1 N = 0.2248 lbf, 1 MPa = 145.0 psi

<sup>1</sup>Development lengths valid for static, wind, and earthquake loads (SDC A and B).

<sup>2</sup>Development lengths in SDC C through F must comply with ACI 318-19 and ACI 318-14 Chapter 18 or ACI 318-11 Chapter 21 and Section 4.2.4 of this report.

<sup>3</sup>For sand-lightweight concrete, increase development length by 33%, unless the provisions of ACI 318-19 25.4.2.5, ACI 318-14 25.4.2.4 or ACI 318-11 12.2.4 (d) are met to permit  $\lambda > 0.75$ .

<sup>4</sup> $\left(\frac{c_b + K_{tr}}{d_b}\right) = 2.5$ ,  $\psi_t = 1.0$ ,  $\psi_e = 1.0$ ,  $\psi_s = 0.8$  for  $d_b < 20$ M, 1.0 for  $d_b \geq 20$ M.



English  
Français  
Español  
Português

Hilti HIT-HY 200-A V3  
Hilti HIT-HY 200-R V3

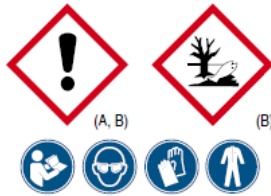

**Warning**  
Contains: hydroxypropylmethacrylate (A)  
2,2'-(m-tolylimino)diethanol (A) 1,4-Butandiol-dimet-  
hacrylat (A) dibenzoyl peroxide (B) May cause an  
allergic skin reaction. (A, B) Causes serious eye  
irritation. (B) Very toxic to aquatic life with long lasting  
effects. (B)

Hilti HIT-HY 200-A/R V3

1		7		13		19	
2		8		14		20	ECO
3		9		15		21	
4		10		16			
5		11		17			
6		12		18			

Rebar  $h_{ef} \geq 20d$

			$h_{ef}$		
HIT-HY 200-A	HDM, HDE	$\leq$ US #5	12 1/2 ... 37 1/2 [inch]	14°F...104°F	50°F...86°F
HIT-HY 200-R V3		$\leq$ EU 16mm	320 ... 960 [mm]	-10°C...40°C	10°C...30°C
		$\leq$ CAN 15M	320 ... 960 [mm]		
HIT-HY 200-A	HDE	$\leq$ US #5	12 1/2 ... 37 1/2 [inch]	14°F...104°F	32°F...86°F
HIT-HY 200-R V3		$\leq$ EU 16mm	320 ... 960 [mm]	-10°C...40°C	0°C...30°C
		$\leq$ CAN 15M	320 ... 960 [mm]		
HIT-HY 200-R V3	HDE	$\leq$ US #8	20 ... 60 [inch]	32°F...104°F	32°F...86°F
		$\leq$ EU 25mm	500 ... 1500 [mm]	0°C...40°C	0°C...30°C
		$\leq$ CAN 25M	504 ... 1512 [mm]		
HIT-HY 200-R V3	HDE	$\leq$ US #10	25 ... 75 [inch]	50°F...86°F	50°F...86°F
		$\leq$ EU 32mm	640 ... 1920 [mm]	10°C...30°C	10°C...20°C
		$\leq$ CAN 30M	598 ... 1794 [mm]		

			$h_{ef}$		
HIT-HY 200-A	HDM, HDE	$\leq$ US #5	12 1/2 ... 37 1/2 [inch]	14°F...104°F	50°F...86°F
HIT-HY 200-R V3		$\leq$ EU 16mm	320 ... 960 [mm]	-10°C...40°C	10°C...30°C
		$\leq$ CAN 15M	320 ... 960 [mm]		
HIT-HY 200-A	HDE	$\leq$ US #5	12 1/2 ... 37 1/2 [inch]	14°F...104°F	32°F...86°F
HIT-HY 200-R V3		$\leq$ EU 16mm	320 ... 960 [mm]	-10°C...40°C	0°C...30°C
		$\leq$ CAN 15M	320 ... 960 [mm]		
HIT-HY 200-R V3	HDE	$\leq$ US #8	20 ... 39 3/8 [inch]	32°F...104°F	32°F...86°F
		$\leq$ EU 25mm	500 ... 1000 [mm]	0°C...40°C	0°C...30°C
		$\leq$ CAN 25M	504 ... 1000 [mm]		

Hilti HIT-HY 200-A/R V3

		HY 200-A V3		HIT-Z	
[°C]	[°F]				
-10...-5	14...23	1.5 h	7 h		
-4...0	24...32	50 min	4 h		
1...5	33...41	25 min	2 h		
6...10	42...50	15 min	75 min	15 min	75 min
11...20	51...68	7 min	45 min	7 min	45 min
21...30	69...86	4 min	30 min	4 min	30 min
31...40	87...104	3 min	30 min	3 min	30 min

		HY 200-R V3		HIT-Z	
[°C]	[°F]				
-10...-5	14...23	3 h	20 h		
-4...0	23...32	90 min	8 h		
1...5	32...41	45 min	4 h		
6...10	41...50	30 min	2.5 h	30 min	2.5 h
11...20	50...68	15 min	1.5 h	15 min	1.5 h
21...30	69...86	9 min	1 h	9 min	1 h
31...40	87...104	6 min	1 h	6 min	1 h

$h_{ef}$ [inch]	$h_{ef}$ [mm]		
0 ... 4	0 ... 100	10 sec	30 sec
4.01 ... 8	101 ... 200	20 sec	40 sec
8.01 ... 12	201 ... 300	30 sec	50 sec
12.01 ... 16	301 ... 400	40 sec	60 sec
16.01 ... 20	401 ... 500	50 sec	70 sec
20.01 ... 25	501 ... 600	60 sec	80 sec

$t_{roughen} [sec] = h_{ef} [inch] / 2.5$        $t_{roughen} [sec] = h_{ef} [mm] / 10$

3

Hilti HIT-HY 200-A/R V3

Fractional/Imperial

d [inch]	US Rebar		CA Rebar		HIS-N, -RN					
	HY 200-A V3	HY 200-R V3	HY 200-A V3	HY 200-R V3	d [inch]	$h_{ef}$ [inch]	$h_{ef}$ [inch]	d [inch]	$h_{ef}$ [inch]	$T_{max}$ [lb-ft]
#3	2 28 ... 22 1/2	3 28								9 1/2
#4	2 34 ... 30	4 1/2	10 M	70 ... 678						5 8
#5	3 18 ... 37 1/2	5 5/8	15 M	80 ... 960	3/8	4 3/8	4 3/8	7/16	3 8 ... 15 1/2	11 1/2
#6	3 1/2 ... 15	6 3/4			1/2	5	5	9/16	1/2 ... 1 3/16	5 3/8
#8	4 ... 15	8 1/2	20 M	90 ... 990						7 8
#7	3 1/2 ... 17 1/2			90 ... 1170						1
#7	17 1/2 ... 82 1/2				5/8	6 3/4		1 1/16	5/8 ... 1 1/2	5 8
#8	4 ... 20									1 1/8
#8	4 1/2 ... 22 1/2	4 1/2 ... 67 1/2	25 M	101 ... 504	3/4	8 1/8		1 3/16	3/4 ... 1 7/8	1 1/4
#10	5 ... 25	5 ... 75	30 M	120 ... 598						1 1/2

ø d [inch]	7/16	1/2	9/16	5/8	11/16	3/4	7/8	1	1 1/8	1 1/4	1 3/8	1 1/2
HIT-RB	7/16	1/2	9/16	5/8	11/16	3/4	7/8	1	1 1/8	1 1/4	1 3/8	1 1/2
HIT-SZ	-	1/2	9/16	5/8	11/16	3/4	7/8	1	1 1/8	1 1/4	1 3/8	1 1/2
HIT-DL	-	1/2	9/16	5/8	11/16	3/4	7/8	1	1	1	1 3/8	1 3/8
HIT-OHC	387551											
TE-YRT	-											

HIT-DL:  $h_{ef} > 10^*$       HIT-RB:  $h_{ef} > 20d$



4

FIGURE 6—MANUFACTURER'S PRINTED INSTALLATION INSTRUCTIONS (MPII)

Fractional/Imperial		Hilti HIT-HY 200-A/R V3											
● HAS / HAS-E / HIT-V					● HIT-Z, HIT-Z-R								
d [inch]	$h_w$ [inch]	$h_w$ [inch]	$T_{hw}$ [lb-ft]	$d_1$ [inch]	$d_2$ [inch]	d [inch]	$h_w$ [inch]	$h_w$ [inch]	$T_{hw}$ HIT-Z [lb-ft]	$T_{hw}$ HIT-Z-R [lb-ft]	$d_1$ [inch]	$d_2$ [inch]	$d_3$ [inch]
3/8	2.38...7.12	3.38	≤15	1/2	7/16	3/8	2.38...4.12	3.38	15	30	1/2	7/16	7/16
1/2	2.34...10	4.12	≤30	5/8	9/16	1/2	2.34...6	4.12	30	60	5/8	9/16	9/16
5/8	3.18...12.1/2	5.98	≤60	13/16	11/16	5/8	3.24...7.1/2	5.98	60	120	13/16	11/16	3/4
3/4	3.1/2...15	6.34	≤100	15/16	13/16	3/4	4...8.1/2	6.34	110	165	15/16	13/16	7/8
7/8	3.1/2...17.1/2	6.34	≤125	1 1/8	19/16								1
1	4...20	-	≤150	1 1/4	1.18								1.18
													1.14
1/4	5...25	-	≤200	1 1/2	1.38								1.38
													1.12

HIT-RE-M				HIT-OHW
Art. No.				Art. No.
337111		HDM 330/500 HDE 500	VC 140/150/300	387550

$d_1$ [inch]	[inch]	Art. No. 381215	
7/8"...1 1/4"	2 1/4"...20"	✓	≥ 6 bar/90 psi @ 6 m³/h
1 1/4"...1 1/2"	4"...25"	-	≥ 140 m³/h/ ≥82 CFM

Hilti HIT-HY 200-A/R V3							Metric Values						
● Rebar				● HIS-N, -RN			● HAS-U / HIT-V						
d [mm]	$h_w$ [mm]	d [mm]	$h_w$ [mm]	d [mm]	$h_w$ [mm]	$T_{hw}$ [Nm]	d [mm]	$h_w$ [mm]	$T_{hw}$ [Nm]	$d_1$ [mm]	$d_2$ [mm]	$d_3$ [mm]	
8	60...480						M8	60-160	≤10	11	9	10	
10	60...600						M10	60-200	≤20	14	12	12	
12	70...720						M12	70-240	≤40	16	14	14	
14	75...1000											16	
16	90...1000	M10	110	12	10-25	≤20	M16	80-320	≤80	20*	18	18	
18	85...1000											20	
20	90...1000	M12	125	14	12-30	≤40	M20	90-400	≤150	24*	22	22	
22	95...1000											25	
24/25	96/100...1000						M24	96-480	≤200	30*	26	28	
28/28	104/112...1000						M27	108-540	≤270	32*	30	30	
30	120...1000											37	
32	126...1000	M20	205	22	20-50	≤150	M30	120-600	≤300	37*	33	35	

Metric Values		Hilti HIT-HY 200-A/R V3									
● HAS-U / HIT-V / HAS / HAS-E					● HIT-Z, -R						
d [mm]	$h_{min}$ [mm]	$T_{hw}$ HIT-Z [Nm]	$T_{hw}$ HIT-Z-R [Nm]	$d_1$ [mm]	$d_2$ [mm]	$d_3$ [mm]	$d_1$ [mm]	$d_2$ [mm]	$d_3$ [mm]	$d_4$ [mm]	$d_5$ [mm]
M8	60-96	10	30	11	9	10	10	10	10		
M10	60-120	25	55	14	12	12	12	12	12		
M12	60-144	40	75	16	14	14	14	14	14		
M16	96-192	80	155	20*	18	18	18	18	18		18
M20	100-220	150	215	24*	22	22	22	22	22		20
						25	25	25	25		25
						28	28	28	28		28
						30	30	30	30		30
						32	32	32	32		32
						35	35	35	35		35

HIT-RB	HIT-SZ	HIT-DL	HIT-OHC	TE-YRT
			4307551	
			4307552	

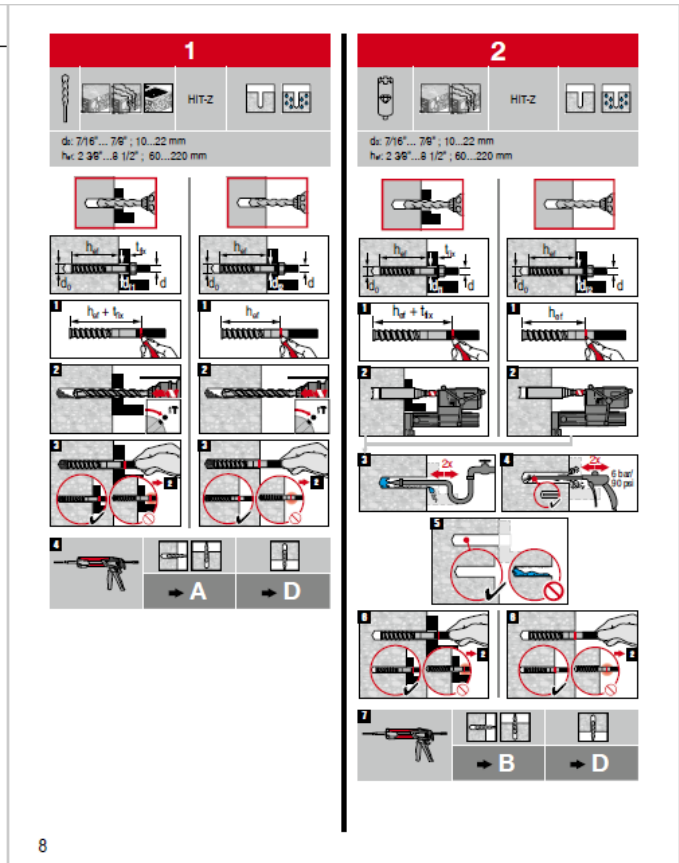

FIGURE 6—MANUFACTURER'S PRINTED INSTALLATION INSTRUCTIONS (MPII) (Continued)

### 3

HIT-Z, HAG, HAG-E, HAS-U, HIT-V, HIS-N, Rebar

di: 7/16" ... 1 1/8" ... 10 ... 35 mm  
hv: 2 3/8" ... 39 3/8" ... 60 ... 1000 mm

### 4

HAG, HAG-E, HAS-U, HIT-V, HIS-N, Rebar

di: 7/16" ... 1 1/2" ... 10 ... 40 mm  
hv: 2 3/8" ... 75 1/2" ... 60 ... 1920 mm

### 5

HAG, HAG-E, HAS-U, HIT-V, HIS-N, Rebar

di: 5/8" ... 1 1/4" ... 18 ... 35 mm  
hv: 3 1/8" ... 25" ... 80 ... 600 mm

### 6

HAS, HAG-E, HAS-U, HIT-V, Rebar

di: 7/16" ... 1 3/4" ... 10 ... 40 mm  
hv: 2 3/8" ... 10" ... 60 ... 250 mm

### A

HIT-RE-M

di: 2 3/8" ... 9 1/2" ... 60 ... 220mm

### B

HIT-Z, HAG, HAG-E, HAS-U, HIT-V, HIS-N / Rebar

HIT-RE-M

di: 2 3/8" ... 9 7/8" ... 60 ... 250mm

9

10

### C

HAG, HAG-E, HAS-U/HIT-V, HIS-N, Rebar

di: 2 3/8" ... 75 1/2" ... 60 ... 1920mm

HIT-RE-M, HIT-SZ

### D

HIT-Z, HAG, HAG-E, HAS-U/HIT-V, HIS-N/Rebar

HIT-RE-M, HIT-SZ, HIT-OWH, HIT-OHC

di: 2 3/8" ... 75 1/2" ... 60 ... 1920mm

### E

HIT-RE-M

### F

HIT-RE-M

11

12

Hilti HIT-HY 200-A/R V3

**EN** Adhesive anchoring system for rebar and anchor fastenings in concrete.

Hilti HIT-HY 200-A/-R V3

Contains: Hydroxypropylmethacrylat (A), 1,4-Butandiol-dimethacrylat (A), Dibenzoylperoxid (B), 2,2-(m-Isobutylphenyl)ethanol (A)



**Warning:** May cause an allergic skin reaction. (A, B) Causes serious eye irritation. (B) Very toxic to aquatic life with long lasting effects. (B) Do not get in eyes, on skin or on clothing. Wear eye protection, protective clothing, protective gloves. If ON SKIN: Wash with plenty of water. If IN EYES: Rinse cautiously with water for several minutes. Remove contact lenses, if present and easy to do. Continue rinsing. If skin irritation or rash occurs: Get medical advice/attention. If eye irritation persists: Get medical advice/attention.

**Disposal considerations:** Empty packs: Leave the mixer attached and dispose of via the local Green Dot recovery system or EAK waste material code: 150102 plastic packaging Full or partially emptied packs: Must be disposed of as special waste in accordance with official regulations. EAK waste material code: 08 04 09 waste adhesives and sealants containing organic solvents or other dangerous substances. or EAK waste material code: 20 01 27\* paint, inks, adhesives and resins containing dangerous substances.

**Product information:** Always keep these instructions together with the product even when given to other persons. **Material Safety Data Sheet:** Review the MSDS before use. **Check expiration date:** See imprint on foil pack manifold (month/year). Do not use after product. **Foil pack temperature during usage:** 0 °C to 40 °C / 32 °F to 104 °F. **Base material temperature at time of installation:** HAS-U, HIT-V, HIS, Rebar: between -10 °C and 40 °C / 14 °F and 104 °F; HIT-Z: between +5 °C and 40 °C / 41 °F and 104 °F. **Conditions for transport and storage:** Keep in a cool, dry and dark place between 5 °C and 25 °C / 41 °F and 77 °F. For any application not covered by this document / beyond values specified, please contact Hilti. **Partly used foil packs must remain in the cassette** and has to be used within **4 weeks**. Leave the mixer attached on the foil pack manifold and store within the cassette under the recommended storage conditions. If reused, attach a new mixer and discard the initial quantity of anchor adhesive.

Failure to observe these installation instructions, use of non-Hilti anchors, poor or questionable concrete conditions, or unique applications may affect the reliability or performance of the fastenings.

**▲ NOTICE**

- ▲ The surface of the HIT-Z anchor rod must not be altered in any way.
- ▲ The thread of HIT-Z must stay free from dirt and dust during the installation procedure and its cones must be fully embedded into mortar (especially at minimum embedment). Torque moment must always be applied on HIT-Z nut and washer installed above a solid basaltic laying on concrete.
- ▲ Improper handling may cause mortar splashes. Always wear safety glasses, gloves and protective clothes during installation. Never start dispensing without a mixer properly screwed on. Attach a new mixer prior to dispensing a new foil pack (ensure snug fit). Use only the type of mixer (HIT-RE-M) supplied with the adhesive. Do not modify the mixer in any way. Never use damaged foil packs and/or damaged or unclear foil pack holders (cassettes).
- ▲ Poor load values / potential failure of fastening points due to inadequate borehole cleaning. Hilti hollow drill bits TE-CD, TE-YD must be used in conjunction with a properly maintained Hilti vacuum cleaner with model and suction capacity (volumetric flow rate) as specified in the accessory table. The boreholes must be free of debris, dust, water, ice, oil, grease and other contaminants prior to adhesive injection. For blowing out the borehole – blow out with oil free air until return air stream is free of noticeable dust. For flushing the borehole – flush with water line pressure until water runs clear. For brushing the borehole – only use specified wire brush. The brush must resist insertion into the borehole – if not the brush is too small and must be replaced. Important! Remove all water from the borehole and blow out with oil free compressed air until borehole is completely dried before mortar injection (not applicable to hammer drilled hole in under water application). Do not exceed the roughening time when roughening the drilled hole!

- ▲ Ensure that boreholes are filled from the back of the borehole without forming air voids. If necessary use the accessories / extensions to reach the back of the borehole. For overhead applications use the overhead accessories HIT-SZ and take special care when inserting the fastening element. Excess adhesive may be forced out of the borehole. Make sure that no mortar drips onto the installer. In water saturated concrete it is required to set the anchor immediately after cleaning the borehole.
- ▲ Not adhering to these setting instructions can result in failure of fastening points!

FIGURE 6—MANUFACTURER'S PRINTED INSTALLATION INSTRUCTIONS (MPII) (Continued)



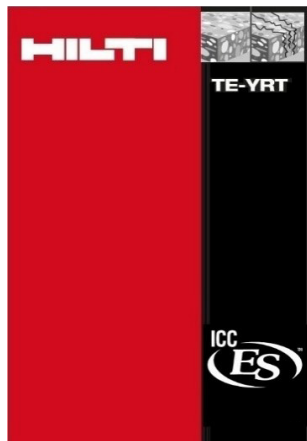

4.1	HILTI Ø d <sub>0</sub> [mm]	TE-YRT
	18	TE-YRT 18/320
	20	TE-YRT 20/320
	22	TE-YRT 22/400
	25	TE-YRT 25/400
	28	TE-YRT 28/480
	30	TE-YRT 30/540
	32	TE-YRT 32/500
	35	TE-YRT 35/600
	HILTI Ø d <sub>0</sub> [inch]	TE-YRT
	3/4"	TE-YRT 3/4" / 12 1/2"
	7/8"	TE-YRT 7/8" / 15"
	1"	TE-YRT 1" / 17 1/2"
	1 1/8"	TE-YRT 1 1/8" / 20"
	1 3/8"	TE-YRT 1 3/8" / 25"

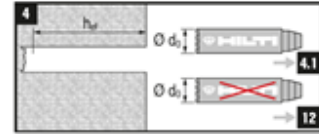
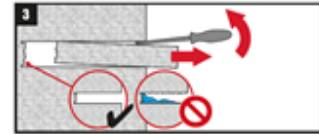
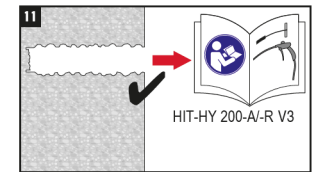
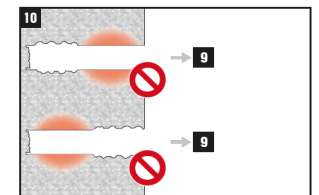
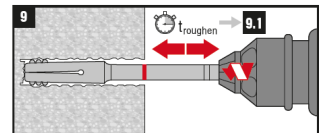
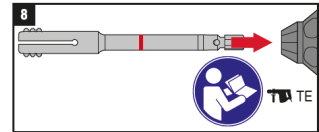
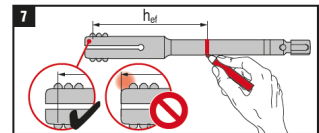
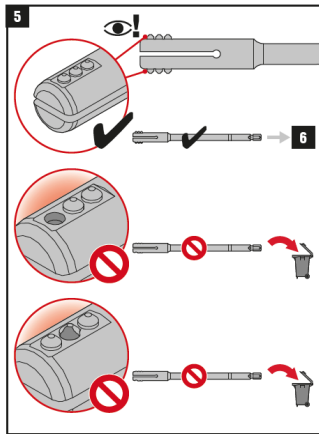
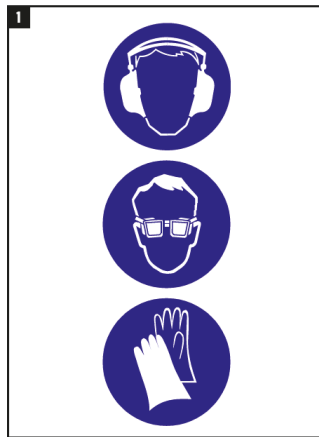
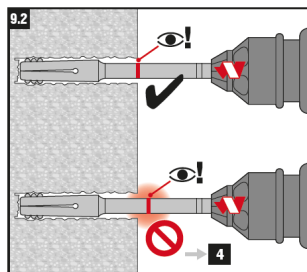
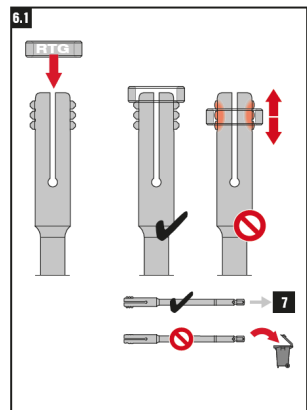

6	TE-YRT	(i) RTG
	TE-YRT 18/320	RTG 18
	TE-YRT 20/320	RTG 20
	TE-YRT 22/400	RTG 22
	TE-YRT 25/400	RTG 25
	TE-YRT 28/480	RTG 28
	TE-YRT 30/540	RTG 30
	TE-YRT 32/500	RTG 32
	TE-YRT 35/600	RTG 35
	TE-YRT	(i) RTG
	TE-YRT 3/4" / 12 1/2"	RTG 3/4"
	TE-YRT 7/8" / 15"	RTG 7/8"
	TE-YRT 1" / 17 1/2"	RTG 1"
	TE-YRT 1 1/8" / 20"	RTG 1 1/8"
	TE-YRT 1 3/8" / 25"	RTG 1 3/8"

9.1	h <sub>ref</sub> [mm]	t <sub>toughen</sub> (= h <sub>ref</sub> /10)
	0 ... 100	10 sec
	101 ... 200	20 sec
	201 ... 300	30 sec
	301 ... 400	40 sec
	401 ... 500	50 sec
	501 ... 600	60 sec
	h <sub>ref</sub> [inch]	t <sub>toughen</sub> (= h <sub>ref</sub> ·2.5)
	0 ... 4	10 sec
	4.01 ... 8	20 sec
	8.01 ... 12	30 sec
	12.01 ... 16	40 sec
	16.01 ... 20	50 sec
	20.01 ... 25	60 sec

12	HILTI Ø d <sub>0</sub> [mm]	TE-YRT
	17,9 ... 18,2	TE-YRT 18/320
	19,9 ... 20,2	TE-YRT 20/320
	21,9 ... 22,2	TE-YRT 22/400
	24,9 ... 25,2	TE-YRT 25/400
	27,9 ... 28,2	TE-YRT 28/480
	29,9 ... 30,2	TE-YRT 30/540
	31,9 ... 32,2	TE-YRT 32/500
	34,9 ... 35,2	TE-YRT 35/600
	HILTI Ø d <sub>0</sub> [inch]	TE-YRT
	0.764 ... 0.776	TE-YRT 3/4" / 12 1/2"
	0.862 ... 0.874	TE-YRT 7/8" / 15"
	1.008 ... 1.020	TE-YRT 1" / 17 1/2"
	1.146 ... 1.157	TE-YRT 1 1/8" / 20"
	1.374 ... 1.386	TE-YRT 1 3/8" / 25"

FIGURE 6—MANUFACTURER'S PRINTED INSTALLATION INSTRUCTIONS (MPII) (Continued)

**DIVISION: 03 00 00—CONCRETE**

Section: 03 16 00—Concrete Anchors

**DIVISION: 05 00 00—METALS**

Section: 05 05 19—Post-Installed Concrete Anchors

**REPORT HOLDER:**

HILTI, INC.

**EVALUATION SUBJECT:****HILTI HIT-HY 200 V3 ADHESIVE ANCHORS AND POST INSTALLED REINFORCING BAR CONNECTIONS IN CONCRETE****1.0 REPORT PURPOSE AND SCOPE****Purpose:**

The purpose of this evaluation report supplement is to indicate that the Hilti HIT HY 200 Adhesive Anchoring System and Post-Installed Reinforcing Bar System for cracked and uncracked concrete, described in ICC-ES evaluation report [ESR-4868](#), has also been evaluated for compliance with the codes noted below as adopted by the Los Angeles Department of Building and Safety (LADBS).

**Applicable code editions:**

- 2020 *City of Los Angeles Building Code* (LABC)
- 2020 *City of Los Angeles Residential Code* (LARC)

**2.0 CONCLUSIONS**

The Hilti HIT-HY 200 V3 Adhesive Anchoring System and Post-Installed Reinforcing Bar System for cracked and uncracked concrete, described in Sections 2.0 through 7.0 of the evaluation report [ESR-4868](#), complies with LABC Chapter 19, and LARC, and is subjected to the conditions of use described in this supplement.

**3.0 CONDITIONS OF USE**

The Hilti HIT HY 200 V3 Adhesive Anchoring System and Post-Installed Reinforcing Bar System described in this evaluation report supplement must comply with all of the following conditions:

- All applicable sections in the evaluation report [ESR-4868](#).
- The design, installation, conditions of use and labeling of the Hilti HIT-HY 200 V3 Adhesive Anchoring System and Post-Installed Reinforcing Bar System are in accordance with the 2018 *International Building Code*® (2018 IBC) provisions noted in the evaluation report [ESR-4868](#).
- The design, installation and inspection are in accordance with additional requirements of LABC Chapters 16 and 17, as applicable.
- Under the LARC, an engineered design in accordance with LARC Section R301.1.3 must be submitted.
- The allowable and strength design values listed in the evaluation report and tables are for the connection of the adhesive anchors and post-installed reinforcing bars to the concrete. The connection between the adhesive anchors or post-installed reinforcing bars and the connected members shall be checked for capacity (which may govern).
- For use in wall anchorage assemblies to flexible diaphragm, anchors shall be designed per the requirements of City of Los Angeles Information Bulletin P/BC 2020-071.

This supplement expires concurrently with the evaluation report, reissued November 2022 and revised March 2023.

**DIVISION: 03 00 00—CONCRETE**

**Section: 03 16 00—Concrete Anchors**

**DIVISION: 05 00 00—METALS**

**Section: 05 05 19—Post-Installed Concrete Anchors**

**REPORT HOLDER:**

HILTI, INC.

**EVALUATION SUBJECT:**

**HILTI HIT-HY 200 V3 ADHESIVE ANCHORS AND POST INSTALLED REINFORCING BAR CONNECTIONS IN CONCRETE**

**1.0 REPORT PURPOSE AND SCOPE**

**Purpose:**

The purpose of this evaluation report supplement is to indicate that the Hilti HIT-HY 200 V3 Adhesive Anchors and Post-Installed Reinforcing Bar System in Concrete, described in ICC-ES evaluation report ESR-4868, has also been evaluated for compliance with the codes noted below.

**Applicable code editions:**

- 2020 Florida Building Code—Building
- 2020 Florida Building Code—Residential

**2.0 CONCLUSIONS**

The Hilti HIT-HY 200 V3 Adhesive Anchor System and Post-Installed Reinforcing Bar System, described in Sections 2.0 through 7.0 of the ICC-ES evaluation report ESR-4868, comply with the *Florida Building Code—Building* and the *Florida Building Code—Residential*, provided the design requirements are in accordance with the *Florida Building Code—Building* or the *Florida Building Code—Residential*, as applicable. The installation requirements noted in ICC-ES evaluation report ESR-4868 for the 2018 *International Building Code*® meet the requirements of the *Florida Building Code—Building* or the *Florida Building Code—Residential*.

Use of the Hilti HIT-HY 200 V3 Adhesive Anchor System and Post-Installed Reinforcing Bar System have also been found to be in compliance with the High-Velocity Hurricane Zone provisions of the *Florida Building Code—Building* and the *Florida Building Code—Residential*, with the following condition:

- a) For anchorage to wood members, the connection subject to uplift must be designed for no less than 700 pounds (3114 N).

For products falling under Florida Rule 61G20-3, verification that the report holder's quality assurance program is audited by a quality assurance entity approved by the Florida Building Commission for the type of inspections being conducted is the responsibility of an approved validation entity (or the code official, when the report holder does not possess an approval by the Commission).

This supplement expires concurrently with the evaluation report, reissued November 2022 and revised March 2023.